

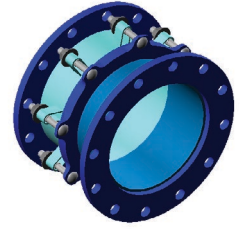

# Smith-Blair

## QUICK CATALOG: WATER





Dear Valued Customer,

Smith-Blair has seen tremendous growth since Telford Smith first began manufacturing repair clamps in his garage in 1939. Today, as a Xylem brand, Smith-Blair is one of the largest pipe fitting manufacturers in the world providing solutions to the water, gas and industrial markets.

The company is headquartered in Texarkana, Arkansas where it maintains an approximately 250,000 square foot manufacturing and warehouse facility. Being centrally located provides the ability to ship rapidly from coast to coast.

This water catalog was designed to be a quick reference and application guide to Smith-Blair's standard water products, HDPE pipe fittings and engineered fabrications. So whether you need a standard product or for one of our engineers to design a fitting to meet a specific application, including domestic only or other special requirements, Smith-Blair has the solution for your water fitting needs.

Our product portfolio is ever growing so if you do not find what you are looking for in this quick catalog, please visit the Smith-Blair web-site ([smith-blair.com](http://smith-blair.com)) for the latest in product information or call us at 800-643-9705.

Kevin Cheatham

President

# Table of Contents

---

Standard Products .....	5
Restraining Pipe.....	6
Repairing Pipe.....	10
Joining Pipe .....	16
Capping Pipe .....	21
Tapping Pipe .....	22
HDPE Products .....	27
Joining HDPE .....	28
Tapping HDPE .....	31
Repairing HDPE .....	32
Engineered Fabrications.....	35

Please refer to Smith-Blair's website ([www.smith-blair.com](http://www.smith-blair.com)) for product capabilities information and technical information such as: product specifications, installation instructions, submittal information as well as product warnings and notices.



The purpose of the Quick Catalog is to promote general awareness of the products and services offered by Smith-Blair







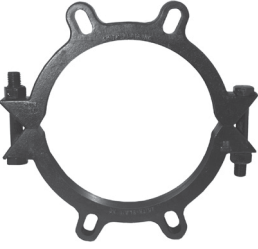

# Standard Products

# Restraining Pipe

PRODUCT	DESCRIPTION	APPLICATION <sup>2,3</sup>	TYPE OF PIPE <sup>4</sup>	NOM PIPE SIZES <sup>5</sup>	WORKING PRESSURE <sup>6,7</sup>
 <p>111</p>	Cam-Lock Joint Restraint	Restraining and sealing pipe ends on MJ fittings	Ductile Iron, Carbon Steel	3" thru 48"	3"-16": 350 PSI Ductile Iron 18"-48": 250 PSI Ductile Iron 3"-12": 250 PSI Carbon Steel
 <p>115</p>	MJ-Lock Joint Restraint	Restraining pipe ends to MJ, hydrants, valves and fittings	PVC, Ductile Iron	4" thru 24" PVC 4"-16" Ductile Iron	Rated at the pressure rating of the PVC pipe it is used on, up to 250 : Up to 350 PSI Ductile Iron
 <p>120</p>	Cam-Lock Joint Restraint	Restraining and sealing pipe ends to MJ fittings	PVC (IPS Sized) PVC (DI Sized)	3" thru 12" 4" thru 36"	Rated at the pressure rating of the PVC pipe it is used on, up to 250 PSI Rated at the pressure rating of the PVC pipe it is used on, up to 235 PSI. 30": 150 PSI, 36": 125 PSI
 <p>136</p>	Bell-Lock Joint Restraint	Restraining push on pipe ends on MJ fittings, pipe bells, hydrants, valves and fittings	PVC (DI Sized)	4" thru 8"	Rated at the pressure rating of the PVC pipe or fitting it is used on, up to 235 PSI. For use on DR 14 or 18.

See page 9 for numbered footnotes.

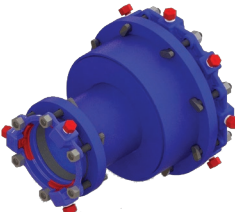

PRODUCT	DESCRIPTION	APPLICATION <sup>2,3</sup>	TYPE OF PIPE <sup>4</sup>	NOM PIPE SIZES <sup>5</sup>	WORKING PRESSURE <sup>6,7</sup>
 165	Bell-Lock Joint Restraint	Restraining push on pipe bells	PVC	4" thru 24" DI Sized 4" thru 12" IPS Sized	Rated at the pressure rating of the PVC pipe it is used on, up to 235 PSI Ductile Iron Sizes up to 250 PSI IPS
 471	Pipe-Lock Joint Restraint Coupling	Connecting plain end Ductile Iron or Steel - Straight	Ductile Iron, Steel	3" thru 48" DI Sized  3" thru 12" IPS Sized	3"-16": 350 PSI 18"-48": 250 PSI Ductile Iron 250 PSI Steel
 472	Pipe-Lock Joint Restraint Coupling	Connecting plain end PVC - Straight	PVC	4" thru 36" DI Sized  3" thru 12" IPS Sized	Rated at the pressure rating of the PVC on which it is used, 3"-24": Up to 235 PSI DI Size 30": 150 PSI, 36": 125 PSI 250 PSI IPS Sized
 473	Pipe-Lock Joint Restraint Coupling	Connecting plain end Ductile Iron or Steel to plain end PVC - Transition	PVC x Ductile Iron Ductile Iron PVC x Steel	4" thru 36" PVC 3" thru 36" Ductile Iron 3" thru 12" IPS Steel	Rated at the pressure rating of the PVC on which it is used, 3"-24". Up to 235 PSI. 30": 150 PSI, 36": 125 PSI DI Size  250 PSI IPS Steel
 474	Pipe-Lock Joint Restraint Coupling	Connecting plain end Ductile Iron or Steel - Reducing	Ductile Iron x Ductile Iron Steel x Steel  Steel x Ductile Iron	3" thru 48" Ductile Iron  3" thru 12" IPS Steel	Rating based on larger of the 2 ODs: 3"-16": 350 PSI, 18"-48": 250 PSI 250 PSI IPS Steel
 475	Pipe-Lock Joint Restraint Coupling	Connecting plain end PVC - Reducing	PVC x PVC	3" thru 36"	Rating based on larger of the 2 ODs. Rated on pressure rating on PVC pipe on which it is installed, 3"-24": Up to 250 PSI. 30": 150 PSI, 36": 125 PSI.

See page 9 for numbered footnotes.

PRODUCT	DESCRIPTION	APPLICATION <sup>2,3</sup>	TYPE OF PIPE <sup>4</sup>	NOM PIPE SIZES <sup>5</sup>	WORKING PRESSURE <sup>6,7</sup>
 <p>476</p>	Pipe-Lock Joint Restraint Coupling	Connecting plain end PVC to plain end Ductile Iron or Steel - Reducing	PVC x Ductile Iron PVC x Steel	4" thru 36" PVC 3" thru 48" Ductile Iron 3" thru 12" IPS Steel	Rated at the pressure rating of the larger of the two PVC pipe on which it is used, 4"-24" Up to 250 PSI. 30": 150 PSI, 36": 125 PSI.
 <p>477</p>	Pipe-Lock Joint Restraint Coupling	Weldment only - Straight and Reducing	PVC, Ductile Iron & Steel	3" thru 48"	3"-16": 350 PSI; 18" -42" : 250 PSI; 48" :200 PSI
 <p>911</p>	Flange-Lock Flange Coupling Adapter	Connecting & restraining to flanged fittings plain end pipe	Ductile Iron, Steel	3" thru 48" Ductile Iron 3" thru 12" IPS Steel	3"-12": 175 PSI Greater than 14": 150 PSI
 <p>920</p>	Flange-Lock Flange Coupling Adapter	Connecting & restraining to flanged fittings plain end pipe	PVC	3" thru 36"	3"-12": 175 PSI Greater than 14": 150 PSI
 <p>907</p>	Flange x Flange Restraint Plate	Restraining flange x flange piping connections	Any Flange x Flange Material	Any size and style of bolted flange	Based on application
 <p>909</p>	AWWA M-11 Style Harness Assembly	Restraining steel pipe joints	Steel	6" and larger	Based on application

See page 9 for numbered footnotes.







PRODUCT	DESCRIPTION	APPLICATION <sup>2,3</sup>	TYPE OF PIPE <sup>4</sup>	NOM PIPE SIZES <sup>5</sup>	WORKING PRESSURE <sup>6,7</sup>
	Fittings with optional Anchor Studs	Restraining couplings and flanged coupling adapters	Steel or Ductile	See specific product for sizes	Based on application
 Maxi Grip EZWR/EZWS	Restraint Coupling	Connecting and restraining plain-end pipe Straight & Reducing	Ductile Iron, PVC, Steel	1 1/4" thru 12"	Steel - 300 PSI PVC - 235 PSI Ductile Iron - 300 PSI
 Maxi-Grip EZWF	Restrained Flanged Coupling Adapter	Connecting and restraining plain end pipe to flanged pipe	Ductile Iron, PVC, Steel	2" thru 12"	175 PSI
 Maxi-Grip EZWC	Restrained Line Cap	Self restraining pipe end cap	Steel, PVC, Ductile Iron	2" thru 12"	Steel-300 PSI PVC-235 PSI Ductile Iron-300 PSI

- 1 Consult Smith-Blair Customer Service 800-643-9705 for applications not in this guide (i.e. high pressure or larger sizes than listed).
- 2 Suitable anchorage (restraint) must be provided when pipe movement in the fitting can occur.
- 3 Ridged pipe stiffeners are required for PVC application thinner than DR26.
- 4 Not all pipe sizes and wall thicknesses are accommodated within one product style.
- 5 Not all pipe sizes and pipe types are accommodated by any one product line.
- 6 Not all pipe sizes and pipe types meet the pressure ratings listed in the tables.
- 7 Higher working pressure design available.

# Repairing Pipe

PRODUCT <sup>1</sup>	DESCRIPTION	APPLICATION <sup>2,3</sup>	TYPE OF PIPE <sup>4</sup>	NOM PIPE SIZES <sup>5</sup>	WORKING PRESSURE <sup>6,7</sup>
 <p>221</p>	Full Circle Repair Clamp, Low Pressure	Complete breaks, splits, holes in pipe	Steel, Cast Iron, Asbestos Cement, PVC, Ductile Iron, Other	2" thru 14"	Up to 50 PSI
 <p>226</p>	Full Circle Repair Clamp, Single Band	Complete breaks, splits, holes in pipe	Steel, Cast Iron, Asbestos Cement, PVC, Ductile Iron, Other	2" thru 14"	Up to 300 PSI
 <p>227</p>	Full Circle Repair Clamp, Double Band	Complete breaks, splits, holes in pipe	Steel, Cast Iron, Asbestos Cement, PVC, Ductile Iron, Other	3" thru 12"	Up to 175 PSI
 <p>228</p>	Full Circle Repair Clamp, Multi-Band	Complete breaks, splits, holes in pipe	Steel, Cast Iron, Asbestos Cement, PVC, Ductile Iron, Other	14" and larger	Up to 125 PSI
 <p>229</p>	Full Circle Collar-Leak Clamp	Leaking plastic solvent weld belled end pipe	Class 160 PVC Solvent Weld Bells	2" thru 12"	Up to 150 PSI
 <p>238</p>	Full Circle Repair Clamp, Double Band, Tapped	Leaks at service outlet. Outlet sizes 3/4" thru 2"	Steel, Cast Iron, Asbestos Cement, PVC, Ductile Iron, Other	3" thru 12"	Up to 300 PSI



See page 15 for numbered footnotes.

PRODUCT <sup>1</sup>	DESCRIPTION	APPLICATION <sup>2,3</sup>	TYPE OF PIPE <sup>4</sup>	NOM PIPE SIZES <sup>5</sup>	WORKING PRESSURE <sup>6,7</sup>
 <p>239</p>	Full Circle Repair Clamp, Double Band, Tapped	Leaks at service outlet 3/4" thru 2"	Steel, Cast Iron, Asbestos Cement, PVC, Ductile Iron, Other	4" thru 12"	Up to 175 PSI
 <p>244</p>	Full Circle Redi-Clamp	Pin hole leaks, punctures, splits and full breaks	PVC, Copper, Steel	1/2" thru 2"	Up to 150 PSI
 <p>245</p>	Redi-Clamp	Pin hole leaks, punctures; splits in pipe	PVC, Copper, Steel	1/2" thru 12"	Up to 150 PSI
 <p>246</p>	Pipe Repair Clamp, Multi-Band	Pin hole leaks and punctures; splits in pipe	PVC, Copper, Steel	10" and larger	Up to 125 PSI
 <p>247</p>	Full Circle Redi-Clamp	Pin hole leaks, punctures, splits and full breaks	PVC, Copper, Steel	1/2" thru 2"	Up to 150 PSI

See page 15 for numbered footnotes.

PRODUCT <sup>1</sup>	DESCRIPTION	APPLICATION <sup>2,3</sup>	TYPE OF PIPE <sup>4</sup>	NOM PIPE SIZES <sup>5</sup>	WORKING PRESSURE <sup>6,7</sup>
 <p>248</p>	Redi-Clamp, Cast, Stainless Steel Lug	Pin hole leaks and punctures; splits in pipe	PVC, Copper, Steel	1/2" thru 12"	Up to 150 PSI
 <p>256</p>	Full Circle Repair Clamp, Single Band, Cast, Stainless Steel Lug	Complete breaks, splits, holes in pipe	Steel, Cast Iron, Asbestos Cement, PVC, Ductile Iron, Other	2" thru 12"	Up to 300 PSI
 <p>257</p>	Full Circle Repair Clamp, Double Band, Cast, Stainless Steel Lug	Complete breaks, splits, holes in pipe	Steel, Cast Iron, Asbestos Cement, PVC, Ductile Iron, Other	4" thru 12"	Up to 175 PSI
 <p>261</p>	Full Circle Repair Clamp, Single Band, All Stainless Steel	Complete breaks, splits, holes in pipe	Steel, Cast Iron, Asbestos Cement, PVC, Ductile Iron, Other	2" thru 12"	Up to 150 PSI
 <p>262</p>	Full Circle Repair Clamp, Double Band, All Stainless Steel	Complete breaks, splits, holes in pipe	Steel, Cast Iron, Asbestos Cement, PVC, Ductile Iron, Other	3" thru 12"	Up to 175 PSI
 <p>264</p>	Full Circle Repair Clamp, Single Band, All Stainless Steel, Tapped	Leaks at service outlet. Outlet sizes 3/4" thru 2"	Steel, Cast Iron, Asbestos Cement, PVC, Ductile Iron, Other	3" thru 8"	Up to 300 PSI



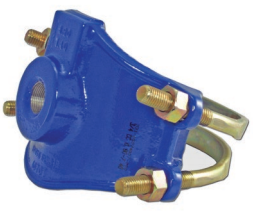

See page 15 for numbered footnotes.

PRODUCT <sup>1</sup>	DESCRIPTION	APPLICATION <sup>2,3</sup>	TYPE OF PIPE <sup>4</sup>	NOM PIPE SIZES <sup>5</sup>	WORKING PRESSURE <sup>6,7</sup>
 <p>265</p>	Full Circle Repair Clamp, Double Band, All Stainless Steel, Tapped	Leaks at service outlet. Outlet sizes 3/4" thru 2"	Steel, Cast Iron, Asbestos Cement, PVC, Ductile Iron, Other	4" thru 12"	Up to 175 PSI
 <p>267</p>	Full Circle Repair Clamp, Carbon Steel	High pressure Not for full break	Steel, Cast Iron, Asbestos Cement, PVC, Ductile Iron, Other	4" and Larger	Up to 225 PSI
 <p>268</p>	Full Circle Repair Clamp, All Stainless Steel	High pressure Not for full break	Steel, Cast Iron, Asbestos Cement, PVC, Ductile Iron, Other	4" and Larger	Up to 225 PSI
 <p>269</p>	Full Circle Collar Leak Clamp, All Stainless Steel	Leaking plastic solvent weld belled end pipe	Class 160 PVC Solvent Weld Bells	2" thru 12"	Up to 150 PSI
 <p>274</p>	Bell Joint Leak Clamp	Leaking bell joints	Cast Iron, Rubber Ring and Caulk Joint	2" thru 36"	150 PSI
 <p>331</p>	Repair Service Saddle	Leaks at service outlet. Outlet sizes 3/4" thru 2"	Cast Iron and Asbestos Cement	4" thru 12"	Up to 200 PSI

See page 15 for numbered footnotes.

PRODUCT <sup>1</sup>	DESCRIPTION	APPLICATION <sup>2,3</sup>	TYPE OF PIPE <sup>4</sup>	NOM PIPE SIZES <sup>5</sup>	WORKING PRESSURE <sup>6,7</sup>
 411	Steel Coupling	Replace split or excessively damaged pipe	All Types	1/2"-16" 18"- 36" 42" & larger	300 PSI 250 PSI Based on application
 418	Bolted Tee Coupling with threaded outlet	Replace split or excessively damaged pipe	Steel, PVC	3/4" thru 2"	150 PSI
 421	Top Bolt Wide Range, 2 Bolt Coupling	Joining a wide range of pipe diameters with unique gasket system	Ductile Iron, Steel Asbestos Cement, PVC, Other	2" thru 12" 10" & 12" Oversize 16"	2"-12": 260 PSI 16": 230 PSI
 422	Top Bolt Wide Range, 2 Bolt Coupling, Long Sleeve	Replaces split or excessively damaged pipe	Ductile Iron, Steel Asbestos Cement, PVC, Other	2" thru 12" ; 16"	2" thru 12" : 260 PSI 16": 230 PSI
 441	OMNI Cast Coupling	Replace split or excessively damaged pipe	Ductile Iron, Steel, Asbestos Cement, PVC, Other	Straight: 2" thru 16" Reducing: 2 1/2" thru 8"	250 PSI
 442	OMNI Cast Coupling 12" Long Sleeves	Replace split or excessively damaged pipe	Ductile Iron, Steel, Asbestos Cement, PVC, Other	4" thru 16"	250 PSI
 461	Quantum Wide Range Coupling	Replace split or excessively damaged pipe	Ductile Iron, Steel, Asbestos Cement, PVC, Other	1 1/2" thru 12"	250 PSI

See page 15 for numbered footnotes.

PRODUCT <sup>1</sup>	DESCRIPTION	APPLICATION <sup>2,3</sup>	TYPE OF PIPE <sup>4</sup>	NOM PIPE SIZES <sup>5</sup>	WORKING PRESSURE <sup>6,7</sup>
 <p>462</p>	Quantum Wide Range Coupling Long Sleeve	Replace split or excessively damaged pipe	Ductile Iron, Steel, Asbestos Cement, PVC, Other	4" thru 12"	250 PSI
 <p>525</p>	Compression Coupling	Replace split or excessively damaged pipe	PVC, Copper, Steel	1/2" thru 2"	150 PSI
 <p>912</p>	Cast Flanged Coupling Adapter	Replace cracked pipe or spooled flanges	All Types	3" thru 12"	250 PSI
 <p>913</p>	Steel Flanged Coupling Adapter	Replace cracked pipe or spooled flanges	All Types	3" and larger	3" thru 12": 175 PSI Greater than 14": 150 PSI

**1** Consult Smith-Blair Customer Service 800-643-9705 for applications not in this guide (i.e. high pressure or larger sizes than listed).

**2** Suitable anchorage (restraint) must be provided when pipe movement in the fitting can occur.

**3** Ridged pipe stiffeners are required for PVC application thinner than DR26.

**4** Not all pipe sizes and wall thicknesses are accommodated within one product style.

**5** Not all pipe sizes and pipe types are accommodated by any one product line.

**6** Not all pipe sizes and pipe types meet the pressure ratings listed in the tables.





**7** Higher working pressure design available.

# Joining Pipe



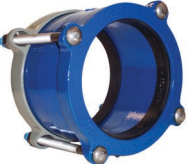



PRODUCT <sup>1</sup>	DESCRIPTION	APPLICATION <sup>2,3</sup>	TYPE OF PIPE <sup>4</sup>	NOM PIPE SIZES <sup>5</sup>	WORKING PRESSURE <sup>6,7</sup>
 <p>411</p>	Steel Coupling	Joining plain-end pipe of same outside diameters	Steel, Cast Iron, Asbestos Cement, PVC, Other	1/2"-16" 18"-36" 42" & larger	300 PSI 250 PSI Based on application
 <p>413</p>	Steel Transition Coupling	Joining pipe of different outside diameters	Steel, Cast Iron, Asbestos Cement, PVC, Other	2" and larger	150 PSI Plus, according to design
 <p>415</p>	Steel Reducing Coupling	Joining pipe of different outside diameters	Steel, Cast Iron, Asbestos Cement, PVC, Other	4" and larger	150 PSI Plus, according to design
 <p>416</p>	Steel Insulating Coupling	Joining pipe insulating one from the other	Steel, Cast Iron	2" and larger	150 PSI
 <p>418</p>	Bolted Tee Coupling With Threaded Outlet	Joining plain-end pipe of same outside diameters	Steel, PVC	3/4" thru 2"	150 PSI Plus, according to design
 <p>421</p>	Top Bolt Wide Range, 2 Bolt Coupling	Joining a wide range of pipe diameters with unique gasket system	Ductile Iron, Steel Asbestos Cement, PVC, Other	2" thru 12" 10" & 12" Oversize 16"	2"-12": 260 PSI 16": 230 PSI

See page 21 for numbered footnotes.



PRODUCT <sup>1</sup>	DESCRIPTION	APPLICATION <sup>2,3</sup>	TYPE OF PIPE <sup>4</sup>	NOM PIPE SIZES <sup>5</sup>	WORKING PRESSURE <sup>6,7</sup>
 422	Top Bolt Wide Range, 2 Bolt Coupling, Long Sleeve	Replaces split or excessively damaged pipe	Ductile Iron, Steel Asbestos Cement, PVC, Other	2" thru 12" 16"	2" thru 12": 260 PSI 16": 230 PSI
 441	OMNI Cast Coupling	Joining plain-end pipe of same outside diameters	Steel, Cast Iron, Asbestos Cement, PVC, Ductile Iron, Other	2" thru 16"	250 PSI
 442	OMNI Cast Coupling 12" Long Sleeves	Joining plain-end pipe of same outside diameters	Steel, Cast Iron, Asbestos Cement, PVC, Ductile Iron, Other	4" thru 16"	250 PSI
 461	Quantum Wide Range Coupling	Joining plain-end pipe of same nominal size	Ductile Iron, Steel, Asbestos Cement, PVC, Other	1 1/2" thru 12"	250 PSI
 462	Quantum Wide Range Coupling with Long Sleeve	Joining plain-end pipe of same nominal size	Ductile Iron, Steel, Asbestos Cement, PVC, Other	4" thru 12"	250 PSI
 471	Pipe-Lock Joint Restraint Coupling	Connecting plain-end Ductile Iron or Steel - Straight	Ductile Iron, Steel	3" thru 48" DI Sized 3" thru 12" IPS Sized	3"-16": 350 PSI (Ductile Iron) 18"-48": 250 PSI (Ductile Iron) 250 PSI (Steel)
 472	Pipe-Lock Joint Restraint Coupling	Connecting plain-end PVC - Straight	PVC	4" thru 36" DI Sized 3" thru 12" IPS Sized	Rated at the pressure rating of the PVC pipe it is used on, 3"-24" up to 250 PSI. 30": 150 PSI, 36": 125 PSI DI Sizes 250 PSI IPS Sizes

See page 21 for numbered footnotes.

PRODUCT <sup>1</sup>	DESCRIPTION	APPLICATION <sup>2,3</sup>	TYPE OF PIPE <sup>4</sup>	NOM PIPE SIZES <sup>5</sup>	WORKING PRESSURE <sup>6,7</sup>
 473	Pipe-Lock Joint Restraint Coupling	Connecting plain-end Ductile Iron or Steel to plain-end PVC - Transition	PVC x Ductile Iron PVC x Steel	3" thru 36" PVC 3" thru 36" Ductile Iron 3" thru 12" IPS Steel	Rated at the pressure rating of the PVC it is used on, 3"-24": Up to 235 PSI. 30": 150 PSI, 36": 125 PSI  250 PSI IPS Steel
 474  475  476	Pipe-Lock Joint Restraint Coupling	Connecting plain-end Ductile Iron or Steel - Reducing	Ductile Iron x Ductile Iron Steel x Steel Steel x Ductile Iron	3" thru 48" Ductile Iron 3" thru 12" Iron Pipe Steel	Rating based on the larger of the two ODs: 3"-16": 350 PSI. 18"-48": 250 PSI Ductile Iron 250 PSI IPS Steel
	Pipe-Lock Joint Restraint Coupling	Connecting plain-end PVC - Reducing	PVC x PVC	3" thru 36"	Rating based on larger of the 2 ODs. Rated at pressure rating of PVC Pipe on which it is installed. 3"-24": up to 250 PSI. 30": 150 PSI, 36": 125 PSI.
	Pipe-Lock Joint Restraint Coupling	Connecting plain-end PVC to plain-end Ductile Iron or Steel - Reducing	PVC x Ductile Iron PVC x Steel	4" thru 36" PVC 3" thru 48" Ductile Iron 3" thru 12" IPS Steel	Rated at the pressure rating of the larger PVC pipe it is used on. 3"-24" Up to 250 PSI. 30": 150 PSI, 36": 125 PSI.
 525	Compression Coupling	Joining plain-end pipe of same outside diameters	PVC, Copper, Steel	1/2" thru 2"	150 PSI
 911	Flange-Lock Flange Coupling Adapter	Connecting & restraining plain-end pipe to flanged fittings	Ductile Iron, Steel	3" thru 48" Ductile Iron 3" thru 12" IPS Steel	3"-12" Flange : 175 PSI Greater than 14": 150 PSI
 914	Reducing Flanged Coupling Adapter	Joining plain-end to flanged valves and fittings	Ductile Iron, Steel, Asbestos Cement, PVC, Other	3" and larger	3"-12" Flange: 175 PSI Greater than 14": 150 PSI
 920	Flange-Lock Flanged Coupling Adapter	Connecting and restraining plain-end pipe to flanged fittings	PVC	3" thru 36"	3"-12" Flange: 175 PSI Greater than 14" 150 PSI

See page 21 for numbered footnotes.



PRODUCT <sup>1</sup>	DESCRIPTION	APPLICATION <sup>2,3</sup>	TYPE OF PIPE <sup>4</sup>	NOM PIPE SIZES <sup>5</sup>	WORKING PRESSURE <sup>6,7</sup>
 <p>921</p>	Top Bolt Wide Range Flanged Coupling Adapter	Joining plain-end pipe to flanged valves and fittings	Ductile Iron, Steel Asbestos Cement, PVC, Other	2" thru 12"  16"	175 PSI  150 PSI
 <p>923</p>	Flange-Lock Flanged Coupling Adapter	Weldment only-Straight and Reducing	PVC, Ductile Iron, Steel	3" thru 48"	3"-12" Flange 175 PSI Greater than 14" 150 PSI
 <p>926</p>	Meter Coupling	Joining plain-end pipe to oval flanged water meters and joining plain-end pipe to flanged valves and fittings	PVC, Copper, Steel, Cast Iron	1 1/2" thru 2"	175 PSI
 <p>932</p>	Insulating Cast Flanged Coupling Adapter	Joining plain-end pipe to flanged valves and fittings	Steel, Cast Iron, Ductile Iron	3" thru 12"	150 PSI
 <p>933</p>	Insulating Steel Flanged Coupling Adapter	Joining plain-end pipe to flanged valves and fittings	Steel, Cast Iron, Ductile Iron, Large Pipe	2" and larger	150 PSI
 <p>971</p>	Dismantling Joint (Non-Restraint Joint)	Valve, meter, pump and other flanged fitting installations	Any Class D Flanged Pipe	3" and larger	3"-12" Flange 175 PSI Greater than 14" 150 PSI

See page 21 for numbered footnotes.

PRODUCT <sup>1</sup>	DESCRIPTION	APPLICATION <sup>2,3</sup>	TYPE OF PIPE <sup>4</sup>	NOM PIPE SIZES <sup>5</sup>	WORKING PRESSURE <sup>6,7</sup>
<p>972</p>	Dismantling Joint (Heavy Duty Restraint Joint)	Valve, meter, pump and other flanged fitting installations	Any Class D Flanged Pipe	3" and larger	3"-12" Flange 175 PSI Greater than 14" 150 PSI
<p>973</p>	Dismantling Joint (Restraint Joint)	Valve, meter, pump and other flanged fitting installations	Any Class D Flanged Pipe	3" thru 48"	150 PSI
<p>975</p>	Dismantling Joint (Restraint Joint)	Valve, meter, pump and other flanged fitting installations	Any Class D Flanged Pipe	3" and larger	3"-12" 175PSI Greater than 14" 150PSI
<p>Maxi-Grip EZWS/EZWR</p>	Restraint Coupling	Connecting and restraining plain-end pipe (straight & reducing)	Ductile Iron, PVC, Steel	1 1/4" thru 12"	Steel-300 PSI PVC-235 PSI Ductile Iron-300 PSI
<p>Maxi-Grip EZWF</p>	Restrained Flanged Coupling Adapter	Connecting and restraining plain-end pipe to flanged pipe	Ductile Iron, PVC, Steel	2" thru 12"	175 PSI

See page 21 for numbered footnotes.

# Capping Pipe

PRODUCT <sup>1</sup>	DESCRIPTION	APPLICATION <sup>2,3</sup>	TYPE OF PIPE <sup>4</sup>	NOM PIPE SIZES <sup>5</sup>	WORKING PRESSURE <sup>6,7</sup>
 481	Steel End Cap Seal Only	Capping pipe ends	Cast Iron, PVC, Steel, AC, Ductile Iron	2" and larger	150 PSI
 482	Cast Line Cap Seal Only	Capping pipe ends	Cast Iron, PVC, Steel, AC, Ductile Iron	2" thru 12"	250 PSI
 Maxi-Grip EZWC	Restraint Line Cap	Self restraining pipe end cap	Steel, PVC, Ductile Iron	2" thru 12"	Steel-300 PSI PVC-235 PSI Ductile Iron-300 PSI

**1** Consult Smith-Blair Customer Service 800-643-9705 for applications not in this guide (i.e. high pressure or larger sizes than listed).

**2** Suitable anchorage (restraint) must be provided when pipe movement in the fitting can occur.

**3** Ridged pipe stiffeners are required for PVC application thinner than DR26.

**4** Not all pipe sizes and wall thicknesses are accommodated within one product style.

**5** Not all pipe sizes and pipe types are accommodated by any one product line.

**6** Not all pipe sizes and pipe types meet the pressure ratings listed in the tables.

**7** Higher working pressure design available.

# Tapping Pipe

PRODUCT <sup>1</sup>	DESCRIPTION	APPLICATION	TYPE OF PIPE <sup>4</sup>	NOM PIPE SIZES <sup>5</sup>	WORKING PRESSURE <sup>6,7</sup>
 <p>238</p>	Full Circle Repair Clamp, Single Band Tapped	Outlet sizes 3/4" thru 2"	Steel, Cast Iron, Asbestos Cement, PVC, Ductile Iron, Other	3" thru 12"	Up to 300 PSI
 <p>239</p>	Full Circle Repair Clamp, Double Band Tapped	Outlet sizes 3/4" thru 2"	Steel, Cast Iron, Asbestos Cement, PVC, Ductile Iron, Other	4" thru 12"	Up to 175 PSI
 <p>264</p>	Full Circle Repair Clamp All Stainless Steel, Single Band Tapped	Outlet sizes 3/4" thru 2"	Steel, Cast Iron, Asbestos Cement, PVC, Ductile Iron, Other	3" thru 8"	Up to 175 PSI
 <p>265</p>	Full Circle Repair Clamp All Stainless Steel, Double Band Tapped	Outlet sizes 3/4" thru 2"	Steel, Cast Iron, Asbestos Cement, PVC, Ductile Iron, Other	4" thru 12"	Up to 175 PSI
 <p>311</p>	Service Saddle Single Bale, Ductile Iron	Outlet sizes 5/8" thru 2"	Steel, Cast Iron, Asbestos Cement, Ductile Iron	1" thru 14"	Up to 200 PSI
 <p>313</p>	Service Saddle Double Bale, Ductile Iron	Outlet sizes 5/8" thru 4"	Steel, Cast Iron, Asbestos Cement, Ductile Iron	1 1/4" thru 24"	Up to 300 PSI

See page 26 for numbered footnotes.

PRODUCT <sup>1</sup>	DESCRIPTION	APPLICATION	TYPE OF PIPE <sup>4</sup>	NOM PIPE SIZES <sup>5</sup>	WORKING PRESSURE <sup>6,7</sup>
 315	Service Saddle Ductile Iron Body, With Stainless Steel Strap	Outlet sizes 5/8" thru 2"	Steel, Cast Iron, Asbestos Cement, PVC, Ductile Iron, Other	1" thru 14"	Up to 200 PSI
 317	Service Saddle Ductile Iron Body with 2 Stainless Steel Straps	Outlet sizes 5/8" thru 4"	Steel, Cast Iron, Asbestos Cement, PVC, Ductile Iron, Other	1 1/4" thru 24"	Up to 300 PSI
 325	Bronze/Brass Service Saddle With Stainless Steel Straps	Outlet sizes 3/4" thru 2"	PVC, Cast Iron, Steel, Ductile Iron	4" thru 12"	Up to 150 PSI
 331	Repair Service Saddle	Outlet sizes 5/8" thru 2"	Cast Iron, Asbestos Cement, Ductile Iron	4" thru 12"	Up to 200 PSI
 357	Service Saddle Ductile Iron Body with Stainless Steel Straps	Outlet sizes 3" and 4" NPT	PVC, Cast Iron, Steel	6" thru 12"	Up to 150 PSI
 362	Service Saddle Double Strap	Outlet sizes 3/4" thru 2"	Concrete Steel Cylinder	12" thru 36"	Up to 150 PSI

See page 26 for numbered footnotes.

PRODUCT <sup>1</sup>	DESCRIPTION	APPLICATION	TYPE OF PIPE <sup>4</sup>	NOM PIPE SIZES <sup>5</sup>	WORKING PRESSURE <sup>6,7</sup>
 <p>366</p>	Service Saddle Triple Strap	Outlet sizes 3/4" thru 2 1/2"	Steel, Cast Iron, PVC, Asbestos Cement, Ductile Iron, Other	18" thru 40"	Up to 150 PSI
 <p>371</p>	Service Saddle All Stainless Steel, Single Bolt	Outlet sizes 1/2" thru 1"	Steel, Cast Iron, PVC, Asbestos Cement, Ductile Iron, Other	4" thru 12"	Up to 150 PSI
 <p>372</p>	Service Saddle All Stainless Steel, Double Bolt	Outlet sizes 1/2" thru 2"	Steel, Cast Iron, PVC, Asbestos Cement, Ductile Iron, Other	4" thru 12"	Up to 150 PSI
 <p>397</p>	Service Saddle, Ductile Iron Wide Stainless Steel Strap	Outlet sizes 3/4" thru 2"	PVC Ductile Iron	2" thru 12"	Up to 300 PSI
 <p>418</p>	Bolted Tee Coupling with Threaded Outlet	Outlet sizes 3/4" thru 2"	Steel, PVC	3/4" thru 2"	Up to 150 PSI
 <p>622</p>	Tapping Sleeve Carbon Steel and Optional Stainless Steel	4" and larger Flange 3/4"-6" Threaded Outlet	Steel, Cast Iron, Asbestos Cement, PVC, Ductile Iron, Other	4" and larger	Up to 150 PSI

See page 26 for numbered footnotes.



PRODUCT <sup>1</sup>	DESCRIPTION	APPLICATION	TYPE OF PIPE <sup>4</sup>	NOM PIPE SIZES <sup>5</sup>	WORKING PRESSURE <sup>6,7</sup>
 <p>623</p>	Tapping Sleeve Carbon Steel Mechanical Joint	4" and larger Flange 3/4"-6" Threaded Outlet	Steel, Cast Iron, Asbestos Cement, PVC, Ductile Iron, Other	4" and larger	4"-12" Flanges 175 PSI Greater than 14" Flanges 150 PSI
 <p>624</p>	Tapping Sleeve Carbon Steel Mechanical Joint	4" and larger Flange 3/4"-6" Threaded Outlet	Steel, Cast Iron, Asbestos Cement, PVC, Ductile Iron, Other	4" and larger	4"-12" Flanges 175 PSI Greater than 14" Flanges 150 PSI
 <p>625</p>	Tapping Sleeve for Concrete Steel Cylinder Pipe	4" and larger Flange 3/4"-6" Threaded Outlet	Concrete Steel Cylinder	12" and larger	Up to 150 PSI
 <p>662</p>	Tapping Sleeve Stainless Steel, Epoxy Coated Carbon Steel Flange	4" and larger Flange 3/4"-6" Threaded Outlet	Steel, Cast Iron, Asbestos Cement, PVC, Ductile Iron, Other	4" thru 24"	4"-12": 240 PSI 14"-20": 180 PSI 24": 120 PSI
 <p>663</p>	Tapping Sleeve All Stainless Steel	Outlet sizes 4" thru 12"	Steel, Cast Iron, Asbestos Cement, PVC, Ductile Iron, Other	4" thru 24"	4"-12": 240 PSI 14"-20": 180 PSI 24": 120 PSI

See page 26 for numbered footnotes.

PRODUCT <sup>1</sup>	DESCRIPTION	APPLICATION	TYPE OF PIPE <sup>4</sup>	NOM PIPE SIZES <sup>5</sup>	WORKING PRESSURE <sup>6,7</sup>
 664	Tapping Sleeve Stainless Steel, Epoxy Coated Carbon Steel Flange	Outlet sizes 4" thru 12"	Steel, Cast Iron, Asbestos Cement, PVC, Ductile Iron, Other	4" thru 24"	4"-12": 150 PSI 14": 140 PSI 16": 125 PSI 18"-20": 100 PSI 24": 75 PSI
 665	Tapping Sleeve All Stainless Steel	Outlet sizes 4" thru 12"	Steel, Cast Iron, Asbestos Cement, PVC, Ductile Iron, Other	4" thru 24"	4"-12": 150 PSI 14": 140 PSI 16": 125 PSI 18"-20": 100 PSI 24": 75 PSI
 68X	Line Stop Outlet (Screw Plug)	Line stopping and plugging. Available on any style Tapping Sleeve	See Type and Size of Tapping Sleeve	Pipe Size(s): 4" thru 20" Outlet(s): 4" thru 12"	Maximum rating of tapping sleeve up to 150 PSI
 68X	Line Stop Outlet (Pin Plug)	Line stopping and plugging. Available on any style Tapping Sleeve (excluding 66X style)	See Type and Size of Tapping Sleeve	Pipe Size(s): 12" and up Outlet(s): 12" thru 24"	Maximum rating of tapping sleeve up to 150 PSI
 MJ	MJ Outlet	Taps utilizing standard MJ valve. Available on any style Tapping Sleeve.	See Type and Size of Tapping Sleeve	See Type and Size of Tapping Sleeve	See Type and Size of Tapping Sleeve

<sup>1</sup> Consult Smith-Blair Customer Service 800-643-9705 for applications not in this guide (i.e. high pressure or larger sizes than listed).

<sup>2</sup> Suitable anchorage (restraint) must be provided when pipe movement in the fitting can occur.

<sup>3</sup> Ridged pipe stiffeners are required for PVC application thinner than DR26.

<sup>4</sup> Not all pipe sizes and wall thicknesses are accommodated within one product style.

<sup>5</sup> Not all pipe sizes and pipe types are accommodated by any one product line.

<sup>6</sup> Not all pipe sizes and pipe types meet the pressure ratings listed in the tables.

<sup>7</sup> Higher working pressure design available.



Products For

# High Density Polyethylene Pipe

(Water Applications)







# Joining HDPE

COUPLING PRODUCT <sup>1</sup>	PRODUCT TYPE	APPLICATION <sup>2,3</sup>	PIPE DR <sup>4</sup>	FOR NOMINAL PIPE SIZES <sup>5</sup>	WORKING PRESSURE <sup>6</sup>
 <p>411</p>	Steel Coupling	Joining plain-end pipe with same outside diameter	7.3-32.5	2" thru 36"	150 PSI
 <p>413</p>	Steel Transition Coupling	Joining pipe of different outside diameters in same nominal size	7.3-32.5	2" thru 36"	150 PSI
 <p>415</p>	Steel Reducing Coupling	Joining pipe of different outside diameters	7.3-32.5	2" thru 36"	150 PSI
 <p>441</p>	OMNI Cast Coupling	Joining pipe of same or different outside diameters in same nominal size	7.3-32.5	2" thru 16"	250 PSI
 <p>442</p>	OMNI Cast Coupling 12" Long Sleeve	Joining pipe of same or different outside diameters in same nominal size	7.3-32.5	4" thru 16"	250 PSI

See page 30 for numbered footnotes.

COUPLING PRODUCT <sup>1</sup>	PRODUCT TYPE	APPLICATION <sup>2,3</sup>	PIPE DR <sup>4</sup>	FOR NOMINAL PIPE SIZES <sup>5</sup>	WORKING PRESSURE <sup>6</sup>
 <p>461</p>	Quantum Wide Range Coupling	Joining pipe of same or different outside diameters	7.3-32.5	2" thru 12"	250 PSI
 <p>462</p>	Quantum Wide Range Coupling with Long Sleeve	Joining pipe of same or different outside diameters	7.3-32.5	4" thru 12"	250 PSI
 <p>611</p>	Steel expansion joint coupling, flanged end	Absorbing concentrated pipe movement	7.3-32.5	2" thru 36"	150 PSI
 <p>612</p>	Steel double-end expansion joint, flanged end	Absorbing concentrated pipe movement	7.3-32.5	2" thru 36"	150 PSI
 <p>Maxi-Grip EZWF</p>	Restrained flanged coupling adapter	Joining plain-end pipe to flanged valves and fittings	7.3-32.5	2" thru 12"	150 PSI

See page 30 for numbered footnotes.

COUPLING PRODUCT <sup>1</sup>	PRODUCT TYPE	APPLICATION <sup>2,3</sup>	PIPE DR <sup>4</sup>	FOR NOMINAL PIPE SIZES <sup>5</sup>	WORKING PRESSURE <sup>6</sup>
 <p>913</p>	Steel flanged coupling adapter	Joining plain-end pipe to flanged valves and fittings	7.3-32.5	2" thru 36"	2"-12": 175 PSI Greater than 14": 150 PSI
 <p>914</p>	Steel reducing flanged coupling adapter	Joining plain-end pipe to flanged valves and fittings	7.3-32.5	2" thru 36"	2"-12": 175 PSI Greater than 14": 150 PSI
 <p>Maxi-Grip EZWS/EZWR</p>	Restraint Coupling	Restraining pipe Straight & Reducing	7.3-32.5	1 1/4" thru 12"	200 PSI
 <p>C</p>	Stainless Steel Pipe Stiffeners	Pipe stiffener I.D. of pipe required	All	All	N/A

**1** Consult Smith-Blair Customer Service 800-643-9705 for applications not in this guide (i.e. high pressure or larger sizes than listed).

**2** Suitable anchorage (restraint) must be provided when pipe movement in the fitting can occur.

**3** Couplings and clamps used to join HDPE pipe and thin wall PVC require the use of rigid stiffeners.

**4** Not all pipe sizes and wall thicknesses are accommodated within one product style.

**5** Not all pipe sizes and pipe types are accommodated by any one product line.

**6** Not all pipe sizes and pipe types meet the pressure ratings listed in the tables.

# Tapping HDPE

TAPPING PRODUCT <sup>1</sup>	PRODUCT TYPE	APPLICATION <sup>2,3</sup>	PIPE DR <sup>4</sup>	FOR NOMINAL PIPE SIZES <sup>5</sup>	WORKING PRESSURE <sup>6</sup>
 <p>371</p>	Service Saddle with all stainless steel spring washers	Service Tap Outlet Sizes 1/2" thru 1"	7.3-17	4" thru 12"	Up to 150 PSI
 <p>372</p>	Service Saddle with double bolt all stainless steel spring washers	Service Tap Outlet Sizes 1/2 thru 2			
 <p>397</p>	Service Saddle with Ductile Iron body, stainless wide steel straps, with all stainless steel spring washers	Service Tap Outlet Sizes 3/4" thru 2"	7.3-17	2" thru 12"	Up to 150 PSI
 <p>317</p>	Double Strap Service Saddle with stainless steel straps and stainless steel spring washers	Service Tap Outlet Sizes 5/8" thru 2"	7.3-17	4" thru 16"	Up to 150 PSI

**1** Consult Smith-Blair Customer Service 800-643-9705 for applications not in this guide (i.e. high pressure or larger sizes than listed).

**2** Suitable anchorage (restraint) must be provided when pipe movement in the fitting can occur.







**3** Couplings and clamps used to join HDPE pipe require the use of rigid stiffeners.

**4** Not all pipe sizes and wall thicknesses are accommodated within one product style.

**5** Not all pipe sizes and pipe types are accommodated by any one product line.

**6** Not all pipe sizes and pipe types meet the pressure ratings listed in the tables.

# Repairing HDPE

REPAIR PRODUCT <sup>1</sup>	PRODUCT TYPE	APPLICATION	PIPE DR <sup>4</sup>	NOM PIPE SIZES <sup>5</sup>	WORKING PRESSURE <sup>6</sup>
 226	Full Circle repair clamp with stainless steel spring washers Single Band	Splits and holes in pipe	7.3-17	2" thru 14"	Up to 255 PSI
 227	Full Circle repair clamp coupling with stainless steel spring washers Double Band	Splits and holes in pipe	7.3-17	4" thru 14"	Up to 175 PSI
 238	Tapped Full Circle repair clamp coupling with stainless steel spring washers	Outlet sizes 3/4"-2"	7.3-17	3" thru 12"	Up to 255 PSI
 239	Super Range Full Circle repair clamp coupling with stainless steel spring washers	Outlet sizes 3/4"-2"	7.3-17	4" thru 12"	Up to 175 PSI
 244/247	Full Circle Redi Clamp, with stainless steel spring washers. (244) ductile iron lugs; (247) stainless steel lugs.	Pin hole leaks and punctures in pipe	7.3-17	1/2" thru 2"	Up to 150 PSI
 245/248	Redi Clamp, with stainless steel spring washers. (245) ductile iron lugs; (248) stainless steel lugs.	Pin hole leaks, punctures and splits in pipe	7.3-17	2" thru 12"	Up to 150 PSI

See page 33 for numbered footnotes.



REPAIR PRODUCT <sup>1</sup>	PRODUCT TYPE	APPLICATION	PIPE DR <sup>4</sup>	NOM PIPE SIZES <sup>5</sup>	WORKING PRESSURE <sup>6</sup>
 256	Full Circle Repair Clamp with stainless steel spring washers and cast stainless steel lugs	Splits and holes in pipe	7.3-11	2" thru 12"	Up to 255 PSI
 257	Full Circle Repair Clamp with stainless steel spring washers and cast stainless steel lugs	Splits and holes in pipe	7.3-11	4" thru 12"	Up to 175 PSI
 261	Full Circle Repair Clamp with stainless steel spring washers and fabricated stainless steel lugs	Splits and holes in pipe	7.3-11	2" thru 12"	Up to 150 PSI
 262	Full Circle Repair Clamp with stainless steel spring washers and fabricated stainless steel lugs	Splits and holes in pipe	7.3-11	3" thru 12"	Up to 255 PSI
 264	Full Circle Repair Clamp with stainless steel spring washers and fabricated stainless steel lugs	Outlet size 3/4"-2"	7.3-11	3" thru 8"	Up to 255 PSI
 265	Full Circle Repair Clamp with stainless steel spring washers and fabricated stainless steel lugs	Outlet size 3/4"-2"	7.3-11	4" thru 12"	Up to 175 PSI

**1** Consult Smith-Blair Customer Service 800-643-9705 for applications not in this guide (i.e. high pressure or larger sizes than listed).

**2** Suitable anchorage (restraint) must be provided when pipe movement in the fitting can occur.

**3** Couplings and clamps used to join HDPE pipe require the use of rigid stiffeners.

**4** Not all pipe sizes and wall thicknesses are accommodated within one product style.

**5** Not all pipe sizes and pipe types are accommodated by any one product line.

**6** Not all pipe sizes and pipe types meet the pressure ratings listed in the tables.





# Engineered Fabrications

From Design to Delivery, Make Us Part of Your Plan





## We Work With Our Customers To Create Solutions

For over 75 years Smith-Blair has built a solid reputation building repair clamps; couplings; service saddles and flanged coupling adapters. This same quality and craftsmanship is built into every one of our Engineered Fabrications as well. Smith-Blair provides diverse solutions that can involve fittings up to 200" (5,000 mm) in diameter, per AWWA C219 and pressures up to 600 PSI (41 BAR).

Our professional staff works with you to define the exact problem you are trying to solve. They are trained to assist with developing resolutions that simplify the typical problems encountered with initial piping designs. In the following pages, please find some "real world" examples of our designs and craftsmanship in: Dismantling Fittings, Flange Coupling Adapters, Line-Stop Fittings, Bell-Pack Fittings, and many other types of customized water and wastewater system products, including fittings designed to fit elliptical and distorted pipe.

# Smith-Blair Engineered Fabrications Begin With Innovative Designs

We assist engineers, superintendents and managers with developing custom designed solutions for unique problems or to simplify initial piping designs.

On other occasions, Smith-Blair engineers and manufacturing experts collaborate with customers by phone to develop product designs for customer review and approval. Then, a fabrication schedule is set in motion and production begins.



State of the art designs such as this 54" restrained elbow for ductile iron pipe

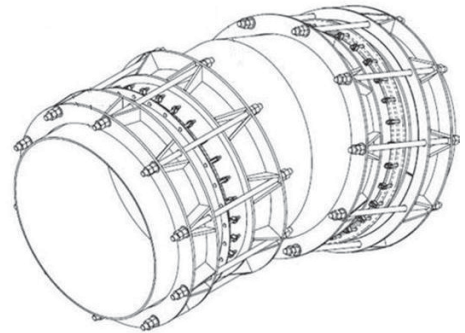

Smith-Blair designs and manufactures the widest variety of fittings for the water and waste water industries. All fittings can be fabricated to your specifications to resolve the most challenging designs.

Our Engineered Fabrications products are fabricated in our Texarkana, Arkansas plant and shipped to customers around the world.

# Some Other Engineered Fabrications Challenges, Capabilities and Solutions

Let us show you how Smith-Blair can help provide solutions for your piping design challenges.



On the left, utility personnel install a Bell-Pack Fitting over failed piping assembly involving multiple existing fittings. This permanent solution was completed in a matter of hours without an interruption to service.



Smith-Blair manufactures large diameter restrained fittings like the 80" coupling seen here to fit almost any pipe, regardless of manufacturer.

Dismantling fittings like the ones pictured here allow for adjustability before and after installation. This feature makes maintenance and repair of any flanged fitting easier and faster.







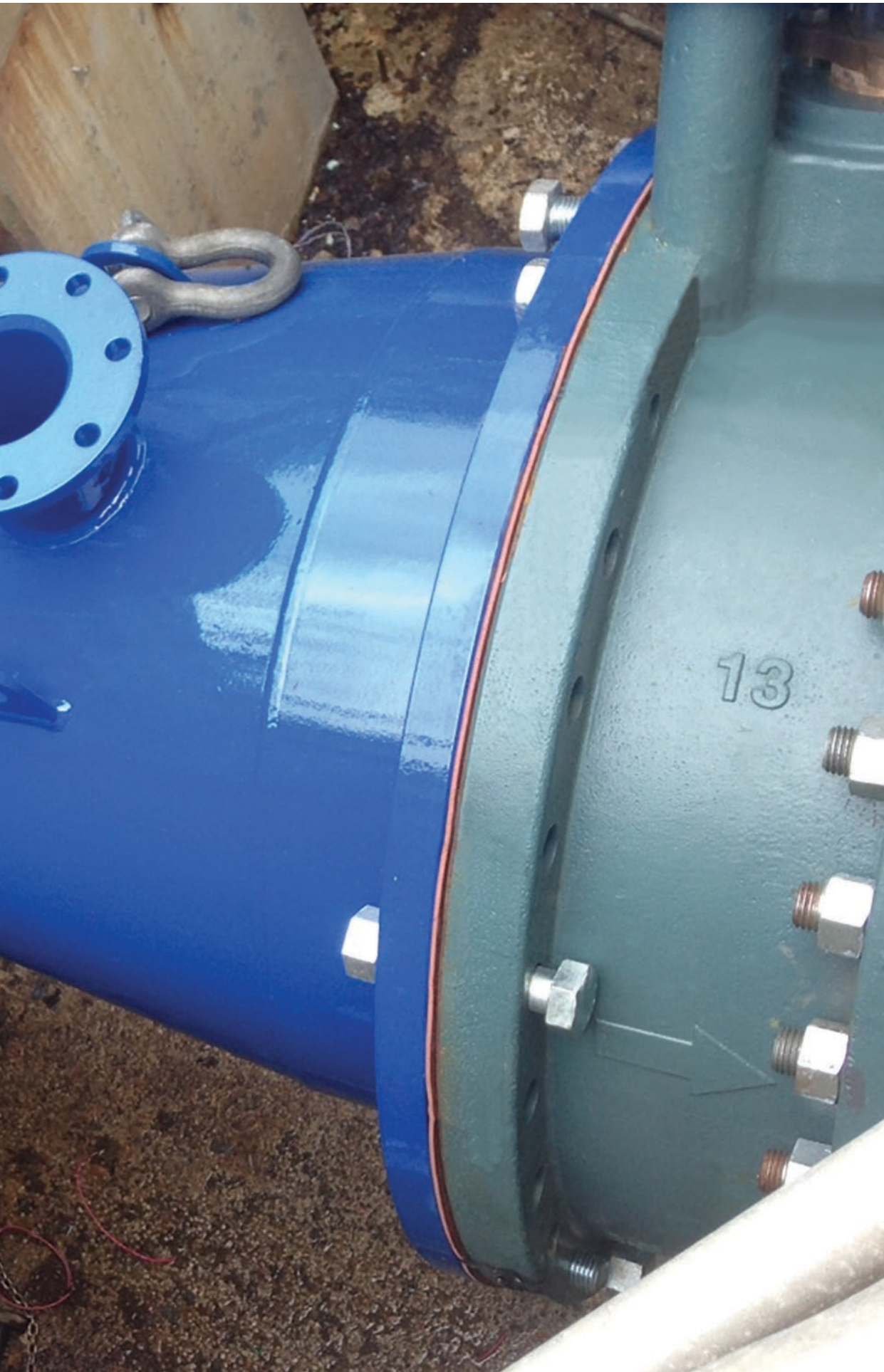

---

This 30" x 24" elongated flanged reducing spool piece was the key element that ensured this installation was completed on time and within budget.

---



On this project, Smith-Blair was called in to resolve a connection that failed due to pipeline settlement. The split offset coupling pictured here permanently connected and sealed the pipeline without removing the existing pipeline or fittings.

Smith-Blair can design and build fittings to meet almost any need. These flange coupling adapters for reinforced concrete pipe and the flanged tee were shipped within a few weeks as opposed to several months required for cast fittings.





Line-Stop fittings installed in conjunction with tapping sleeves provide a means to isolate targeted pipeline sections without interrupting water service. Here we see a wastewater force main that will be relocated for a road widening project.



Trained Smith-Blair factory personnel are ready to assist with resolving the most complex on-site challenges.



## We Always Build To Your Exact Specifications

Our staff takes great pride in doing pre-planning work with the utmost care. Smith-Blair experts believe in asking all of the pertinent questions before a project is started, as we did with these restrained flanged coupling adapters.

# We're Ready To Tackle Your Toughest Assignments

From inception to installation, our experts can help manage your solution each step of the way. Upon request, trained Smith-Blair professionals can accompany the products to the field to answer questions, consult, train, and even assist the crews with the installation process.



## Centrally Located Plant Makes Shipping A Snap

From our Arkansas plant, shipment across North America is easy and efficient. Smith-Blair customer servicespecialistshandlecomplexshippinglogistics to your job site, so it won't be a hassle for you.

Smith-Blair takes pride in our highly skilled U.S. workforce. Our welders and other manufacturing technicians are some of the best in the water and wastewater fabrication industry.



## We Provide Free Lunch & Learns At Your Location for Your Staff's Education

Smith-Blair offers training on up to the minute engineered fabrication solutions and related services through our popular Lunch & Learn Series. Your staff will come away with a broader knowledge of pipeline design, fittings, fabrications techniques, maintenance and testing procedures from organizations like UL, FM, ASTM and AWWA. Schedule your company's free Lunch & Learn today.

From Design To Delivery, Make Us Part of Your Plan. Call us at 800-643-9705. FOR EMERGENCIES, CALL 903-277-9398





*Smith-Blair*  
a xylem brand