

Series e-1510X Smart Pumps

End Suction Centrifugal Pumps
Powered by hydrovar® X



CONTENTS

General Introduction **3**

Applications and Benefits **4**

Performance Coverage at 60 Hz, 2-poles and 4-poles..... **5**

Assembly Configurations **6**

Specifications Document List **9**

Electrical Data **10**

Terminal Block **15**

How to Read Smart Pump Series Curves **16**

Performance Curves for High Speed Models **17**

Performance Curves for Low Speed Models **34**

Materials of Construction **56**

Seal Assemblies **56**

Dimensions and Weights **57**

GENERAL INTRODUCTION

Powered by Xylem's hydrovar® X Motor, Series e-1510X Smart Pumps offer customizable pumping solutions designed to deliver ultra-premium efficiency, connectivity, and simplicity right out of the box!

e-1510X Smart Pumps leverage decades of expertise and know-how in pump technology to bring the right combination of motors, variable speed drives and hydraulic pumps in one comprehensive, highly efficient package. With the largest Efficiency Island compared to similar pumps, the Bell & Gossett Series e-1510X reduces electricity consumption, improves overall system performance and lowers life cycle costs. The extensive energy saving profile enables users to maintain significantly higher levels of efficiency over a much wider range of operating conditions.

So, when it's time to think efficiency, performance and reliable market-leading technology ... start with e-1510X Smart Pumps from Bell & Gossett - a complete system, delivering the solutions you need for today.

HYDRAULIC SPECIFICATIONS

- Maximum flow: up to **1600 GPM (363 m³/hr)**
- Maximum head: up to **400 ft TDH (123 m)**¹
- Hydraulic performance compliant with **ANSI/HI 14.6 Grade 2B**
- Maximum temperature: up to 250 °F (121 °C)²
- Maximum working pressure: 175 psi (12 bar)¹

¹ The 1.25BC and 1.5BC models may exceed the nominal 175 psi rating when operating above 3600 RPM in low-flow conditions. For reliable operation, observe the recommended maximum speed limits indicated on the individual performance curves.

² See mechanical seal options for temperature limitations.

MOTOR SPECIFICATIONS

hydrovar X

- IES2 Power drive system (PDS) efficiency (IEC 61800-9-2:2017)
- IE5 Motor efficiency (IEC TS 60034-30-2:2016)
- NEMA 4
- Insulation class 115 (Class F)
- Totally enclosed fan cooled (TEFC) construction
- 3-Phase power supply
- Rated speeds (high speed models): 3000 - 4000 RPM³
- Rated speeds (low speed models): 1500 - 2000 RPM³
- High speed models: 3 kW to 22 kW (4 HP to 30 HP): 200-240V and 380-480V +/- 10%, 50/60Hz
- Low speed models: 1.5 kW to 11 kW (2 HP to 15 HP): 200-240V and 380-480V +/- 10%, 50/60Hz
- RS485 Communication interface, BACnet and Modbus standard and BLE included
- Overload and locked rotor protection with automatic reset included
- Multi-pump linking (up to 8 pumps)

³ Rated speeds are used to determine the net efficiency of a pump-drive system and for energy efficiency listings. Pumps may or may not utilize the full speed range of hydrovar X depending on a variety of factors or limitations. Models may operate below rated speed at partial loading. See individual performance curves for more detail.

APPLICATIONS

The **e-1510X** is suitable for the following applications:

- Chilled Water
- Commercial HVAC
- Hydronic Heating and Cooling Systems
- Cooling Towers and Industrial Uses
- Pressure Boosting
- General Liquid Transfer

PUMPED FLUIDS

- Unheated domestic and fresh water
- Boiler feed water
- Condensate
- Benign liquids

BENEFITS

The **e-1510X** provides the following benefits:

Ease of installation and maintenance: the integrated pump and hydrovar X motor package eliminates additional wiring, labor, and costs associated with a traditional variable frequency drive (VFD) package. The hydrovar X motor features a quick-connect electrical socket between the motor and drive for rapid maintenance.

Condition monitoring: every e-1510X is fitted with Xylem's optimize® sensor to monitor pump health.

Intelligent performance: advanced control systems embedded within the hydrovar X motor are customizable for a wide range of applications and multi-pump support (up to 8 pumps) for parallel pumping installations.

Simple: the hydrovar X motor is easy to configure and commission. Follow the start-up genie to quickly tailor the motor to its intended application. Control selections and navigate menus via a full color graphical display.

Built-in protections: integrated functions protect the pump and motor when operating near the current and power limits of the system.

High efficiency: the IE5 "ultra-premium" hydrovar X motor provides one of the broadest efficiency ranges in the industry.

PERFORMANCE COVERAGE

e-1510X High Speed Hydraulic Performance

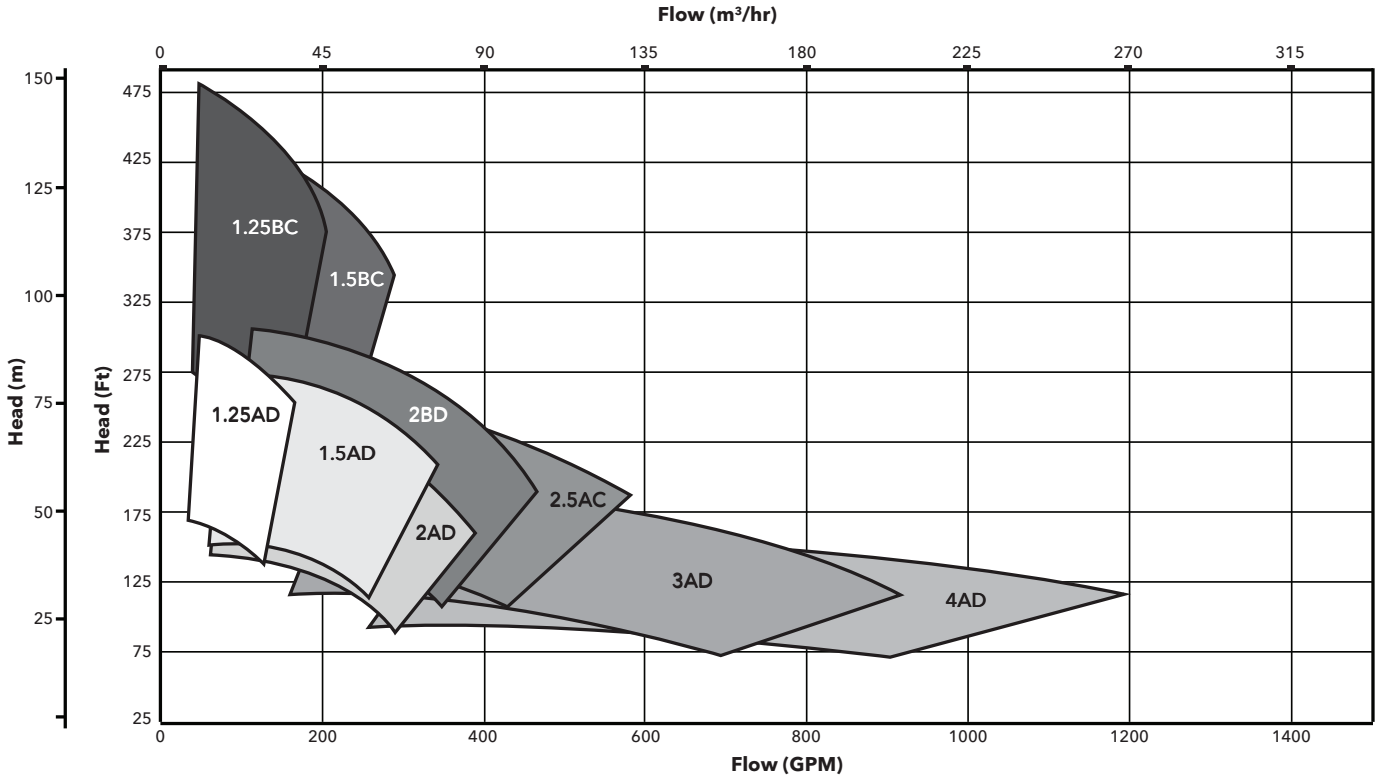

e-1510X Low Speed Hydraulic Performance

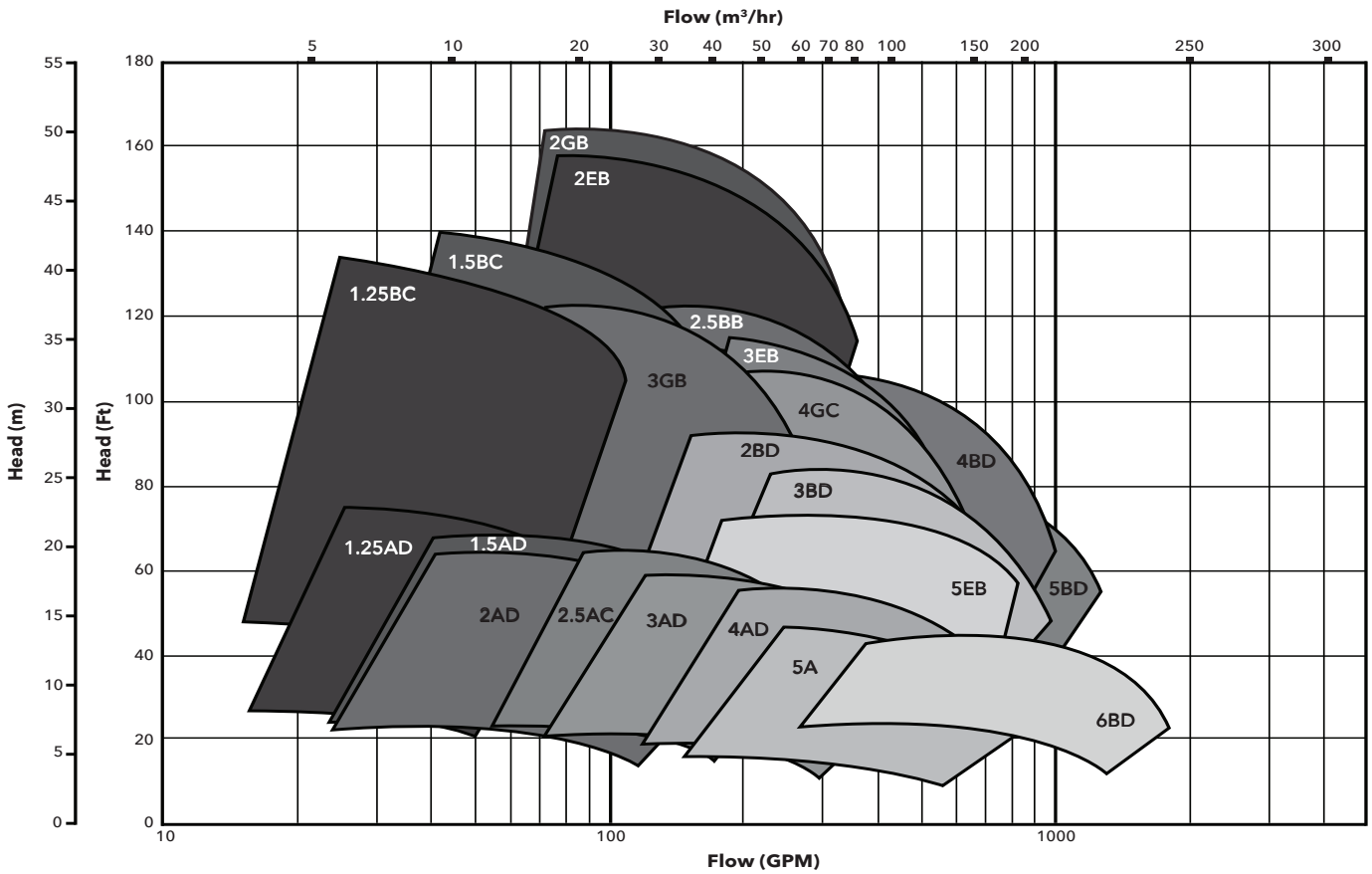

e-1510X SERIES ASSEMBLY CONFIGURATIONS

High Speed (3000-4000 RPM) 3 Phase - 380-480V (460V Nominal Voltage)

Pump Size	Motor Code	Motor Type	e-1510X BUNA PN	e-1510X EPR PN	Motor HP	e-1510 Frame	NEMA Frame	Impeller Trim (in.)
1.25AD	130636290	EXM213- 215/4.150CH2	1510XA1M4SX1	1510XA1M4SX2	15	S	213T	7
1.5AD	130636890	EXM254- 256/4.200DH2	1510XB1N4SX1	1510XB1N4SX2	20	S	254T	7
1.25BC	130637130	EXM254- 256/4.300DH2	1510XA4Q4SX1	1510XA4Q4SX2	30	L	254T	9
1.5BC	130637130	EXM254- 256/4.300DH2	1510XB4Q4SX1	1510XB4Q4SX2	30	L	254T	8.5
2.5AC	130637010	EXM254- 256/4.250DH2	1510XD2P4SX1	1510XD2P4SX2	25	S	254T	7
2AD	130636890	EXM254- 256/4.200DH2	1510XC1N4SX1	1510XC1N4SX2	20	S	254T	7
2BD	130637130	EXM254- 256/4.300DH2	1510XC5Q4SX1	1510XC5Q4SX2	30	L	254T	7.75
3AD	130637130	EXM254- 256/4.300DH2	1510XE1Q4SX1	1510XE1Q4SX2	30	L	254T	6.75
4AD	130637130	EXM254- 256/4.300DH2	1510XF1Q4SX1	1510XF1Q4SX1	30	L	254T	6

High Speed (3000-4000 RPM) 3 Phase - 200-240V (230V Nominal Voltage)

Pump Size	Motor Code	Motor Type	e-1510X BUNA PN	e-1510X EPR PN	Motor HP	e-1510 Frame	NEMA Frame	Impeller Trim (in.)
1.25AD	130636771	EXM254- 256/3.150DH2	1510XA1M4RX1	1510XA1M4RX2	15	S	254T	7
1.5AD	130636891	EXM254- 256/3.200DH2	1510XB1N4RX1	1510XB1N4RX2	20	S	254T	7
1.25BC	130636891	EXM254- 256/3.200DH2	1510XA4N4RX1	1510XA4N4RX2	20	L	254T	8.25
1.5BC	130636891	EXM254- 256/3.200DH2	1510XB4N4RX1	1510XB4N4RX2	20	L	254T	7.5
2.5AC	130636891	EXM254- 256/3.200DH2	1510XD2N4RX1	1510XD2N4RX2	20	S	254T	6.5
2AD	130636891	EXM254- 256/3.200DH2	1510XC1N4RX1	1510XC1N4RX2	20	S	254T	7
3AD	130636891	EXM254- 256/3.200DH2	1510XE1N4RX1	1510XE1N4RX2	20	L	254T	5.875
4AD	130636891	EXM254- 256/3.200DH2	1510XF1N4RX1	1510XF1N4RX1	20	L	254T	5.125

e-1510X SERIES ASSEMBLY CONFIGURATIONS

Low Speed (1500-2000 RPM) 3 Phase - 380-480V (460V Nominal Voltage)

Pump Size	Motor Code	Motor Type	e-1510X BUNA PN	e-1510X EPR PN	Motor HP	e-1510 Frame	NEMA Frame	Impeller Trim (in.)
1.25AD	130635730	EXM143- 145/4.030BH4	1510XA1J5SX1	1510XA1J5SX2	3	S	143T	7
1.5AD	130635730	EXM143- 145/4.030BH4	1510XB1J5SX1	1510XB1J5SX2	3	S	143T	7
1.25BC	130636530	EXM213- 215/4.055CH4	1510XA4K5SX1	1510XA4K5SX2	5.5	L	213T	9.5
1.5BC	130636650	EXM213- 215/4.075CH4	1510XB4L5SX1	1510XB4L5SX2	7.5	S	213T	9.5
2.5AC	130636530	EXM213- 215/4.055CH4	1510XD2N5SX1	1510XD2N5SX2	5.5	S	213T	7
2AD	130635730	EXM143- 145/4.030BH4	1510XC1J5SX1	1510XC1J5SX2	3	S	143T	7
2BD	130636650	EXM213- 215/4.075CH4	1510XC5L5SX1	1510XC5L5SX2	7.5	S	213T	9.5
2.5BB	130637370	EXM254- 256/4.100DH4	1510XD4R5SX1	1510XD4R5SX2	10	L	254T	9.5
3AD	130636530	EXM213- 215/4.055CH4	1510XE1K5SX1	1510XE1K5SX2	5.5	L	215T	7
3BD	130637490	EXM254- 256/4.150DH4	1510XE5M5SX1	1510XE5M5SX2	15	S	254T	9.5
4AD	130636650	EXM213- 215/4.075CH4	1510XF1L5SX1	1510XF1L5SX2	7.5	S	213T	7
4BD	130637490	EXM254- 256/4.150DH4	1510XF5M5SX1	1510XF5M5SX2	15	S	254T	9.25
5A	130637370	EXM254- 256/4.100DH4	1510XG3R5SX1	1510XG3R5SX2	10	L	254T	7
5BD	130637490	EXM254- 256/4.150DH4	1510XG5M5SX1	1510XG5M5SX2	15	S	254T	8.25
6BD	130637490	EXM254- 256/4.150DH4	1510XH5M5SX1	1510XH5M5SX2	15	L	254T	7.5
2EB	130637370	EXM254- 256/4.100DH4	1510XC6R5SX1	1510XC6R5SX2	10	S	254T	10.625
3EB	130637490	EXM254- 256/4.150DH4	1510XE6M5SX1	1510XE6M5SX2	15	S	254T	10.25
4EB	130637490	EXM254- 256/4.150DH4	1510XF6M5SX1	1510XF6M5SX2	15	S	254T	9.5
5EB	130637490	EXM254- 256/4.150DH4	1510XG6M5SX1	1510XG6M5SX2	15	L	254T	9
2GB	130637490	EXM254- 256/4.150DH4	1510XC9M5SX1	1510XC9M5SX2	15	L	254T	12
3GB	130637490	EXM254- 256/4.150DH4	1510XE9M5SX1	1510XE9M5SX2	15	L	254T	10.5
4GC	130637490	EXM254- 256/4.150DH4	1510XF10M5SX1	1510XF10M5SX2	15	L	254T	10

e-1510X SERIES ASSEMBLY CONFIGURATIONS

Low Speed (1500-2000 RPM) 3 Phase - 200-240V (230V Nominal Voltage)

Pump Size	Motor Code	Motor Type	e-1510X BUNA PN	e-1510X EPR PN	Motor HP	e-1510 Frame	NEMA Frame	Impeller Trim (in.)
1.25AD	130635731	EXM143-145/3.030BH4	1510XA1J5RX1	1510XA1J5RX2	3	S	143T	7
1.5AD	130635731	EXM143-145/3.030BH4	1510XB1J5RX1	1510XB1J5RX2	3	S	143T	7
1.25BC	130636531	EXM213-215/3.055CH4	1510XA4K5RX1	1510XA4K5RX2	5.5	L	213T	9.5
1.5BC	130636651	EXM213-215/3.075CH4	1510XB4L5RX1	1510XB4L5RX2	7.5	S	213T	9.5
2.5AC	130636531	EXM213-215/3.055CH4	1510XD2N5RX1	1510XD2N5RX2	5.5	S	213T	7
2AD	130635731	EXM143-145/3.030BH4	1510XC1J5RX1	1510XC1J5RX2	3	S	143T	7
2BD	130636651	EXM213-215/3.075CH4	1510XC5L5SX1	1510XC5L5SX2	7.5	S	213T	9.5
2.5BB	130637371	EXM254-256/3.100DH4	1510XD4R5RX1	1510XD4R5RX2	10	L	254T	9.5
3AD	130636531	EXM213-215/3.055CH4	1510XE1K5RX1	1510XE1K5RX2	5.5	L	215T	7
3BD	130637491	EXM254-256/3.150DH4	1510XE5M5RX1	1510XE5M5RX2	15	S	254T	9.5
4AD	130636651	EXM213-215/3.075CH4	1510XF1L5RX1	1510XF1L5RX2	7.5	S	213T	7
4BD	130637491	EXM254-256/3.150DH4	1510XF5M5RX1	1510XF5M5RX2	15	S	254T	9.25
5A	130637371	EXM254-256/3.100DH4	1510XG3R5RX1	1510XG3R5RX2	10	L	254T	7
5BD	130637491	EXM254-256/3.150DH4	1510XG5M5RX1	1510XG5M5RX2	15	S	254T	8.25
6BD	130637491	EXM254-256/3.150DH4	1510XH5M5RX1	1510XH5M5RX2	15	L	254T	7.5
2EB	130637371	EXM254-256/3.100DH4	1510XC6R5SX1	1510XC6R5SX2	10	S	254T	10.625
3EB	130637491	EXM254-256/3.150DH4	1510XE6M5RX1	1510XE6M5RX2	15	S	254T	10.25
4EB	130637491	EXM254-256/3.150DH4	1510XF6M5RX1	1510XF6M5RX2	15	S	254T	9.5
5EB	130637491	EXM254-256/3.150DH4	1510XG6M5RX1	1510XG6M5RX2	15	L	254T	9
2GB	130637491	EXM254-256/3.150DH4	1510XC9M5RX1	1510XC9M5RX2	15	L	254T	12
3GB	130637491	EXM254-256/3.150DH4	1510XE9M5RX1	1510XE9M5RX2	15	L	254T	10.5
4GC	130637491	EXM254-256/3.150DH4	1510XF10M5RX1	1510XF10M5RX2	15	L	254T	10

hydrovar X MOTOR SPECIFICATIONS DOCUMENT LIST¹

Speed Tier	Motor Type	Voltage Range	Power (hp)	Motor Frame	Specification Document Number
High Speed	EXM56/4.040BH2	380-480V	4	56	XY-hyXeXM-SUB-520
	EXM143-145/4.040BH2		4	143-145	XY-hyXeXM-SUB-521
	EXM143-145/4.055BH2		5.5	143-145	XY-hyXeXM-SUB-522
	EXM143-145/4.075BH2		7.5	143-145	XY-hyXeXM-SUB-523
	EXM213-215/4.075CH2		7.5	213-215	XY-hyXeXM-SUB-524
	EXM213-215/4.100CH2		10	213-215	XY-hyXeXM-SUB-525
	EXM213-215/4.150CH2		15	213-215	XY-hyXeXM-SUB-526
	EXM254-256/4.150DH2		15	254-256	XY-hyXeXM-SUB-527
	EXM254-256/4.200DH2		20	254-256	XY-hyXeXM-SUB-528
	EXM254-256/4.250DH2		25	254-256	XY-hyXeXM-SUB-529
	EXM254-256/4.300DH2		30	254-256	XY-hyXeXM-SUB-530
	EXM56/3.040BH2		200-240V	4	56
	EXM143-145/3.040BH2	4		143-145	XY-hyXeXM-SUB-536
	EXM213-215/3.075CH2	7.5		213-215	XY-hyXeXM-SUB-537
	EXM254-256/3.150DH2	15		254-256	XY-hyXeXM-SUB-538
	EXM254-256/3.200DH2	20		254-256	XY-hyXeXM-SUB-539
Low Speed	EXM56/4.020BH4	380-480V	2	56	XY-hyXeXM-SUB-542
	EXM56/4.030BH4		3	56	XY-hyXeXM-SUB-543
	EXM143-145/4.020BH4		2	143-145	XY-hyXeXM-SUB-544
	EXM143-145/4.030BH4		3	143-145	XY-hyXeXM-SUB-545
	EXM213-215/4.040CH4		4	213-215	XY-hyXeXM-SUB-546
	EXM213-215/4.055CH4		5.5	213-215	XY-hyXeXM-SUB-547
	EXM213-215/4.075CH4		7.5	213-215	XY-hyXeXM-SUB-548
	EXM254-256/4.075DH4		7.5	254-256	XY-hyXeXM-SUB-549
	EXM254-256/4.100DH4		10	254-256	XY-hyXeXM-SUB-550
	EXM254-256/4.150DH4		15	254-256	XY-hyXeXM-SUB-551
	EXM56/3.020BH4	200-240V	2	56	XY-hyXeXM-SUB-552
	EXM56/3.030BH4		3	56	XY-hyXeXM-SUB-553
	EXM143-145/3.020BH4		2	143-145	XY-hyXeXM-SUB-554
	EXM143-145/3.030BH4		3	143-145	XY-hyXeXM-SUB-555
	EXM213-215/3.040CH4		4	213-215	XY-hyXeXM-SUB-556
	EXM213-215/3.055CH4		5.5	213-215	XY-hyXeXM-SUB-557
	EXM213-215/3.075CH4		7.5	213-215	XY-hyXeXM-SUB-558
	EXM254-256/3.075DH4		7.5	254-256	XY-hyXeXM-SUB-559
	EXM254-256/3.100DH4		10	254-256	XY-hyXeXM-SUB-560
	EXM254-256/3.150DH4		15	254-256	XY-hyXeXM-SUB-561

¹ The table above consists of all NEMA frame hydrovar X motor types. Not all motor types are used in the e-1510X product line.

hydrovar X ELECTRICAL DATA

* Please note: Efficiency values shown are power-drive-system (PDS) efficiencies which include the combined losses from both the inverter and motor. The values shown correspond to the full load range of the hydrovar X motor. The hydrovar X motor may operate below the minimum rated speed at partial loading.

Table 1: 56 Frame, High Speed, 380-480V

Pn HP	MOTOR TYPE	NEMA FRAME	SPEED (RPM) min-1	INPUT CURRENT (I) 380-480V A	DATA RELATED TO 460V						
					In	POWER FACTOR cos (φ)	Tn lb.ft	*PDS EFFICIENCY η%			
					A			100	75	50	
4.0	EXM56/4.040BH2	56	3000	6.7-5.3	5.4	0.80	7.04	87.6	87.5	86.0	
			3600		5.3			5.87	88.0	87.4	85.4
			4000		5.3			5.28	88.1	87.1	84.9

Table 2: 56 Frame, High Speed, 200-240V

Pn HP	MOTOR TYPE	NEMA FRAME	SPEED (RPM) min-1	INPUT CURRENT (I) 200-240V A	DATA RELATED TO 230V						
					In	POWER FACTOR cos (φ)	Tn lb.ft	*PDS EFFICIENCY η%			
					A			100	75	50	
4.0	EXM56/3.040BH2	56	-	10.7-8.9	-	0.94	-	-	-	-	
			3600		9.2			5.87	87.2	87.1	85.9
			4000		9.1			5.28	88.0	87.8	86.4

Table 3: 143-145 Frame High Speed, 380-480V

Pn HP	MOTOR TYPE	NEMA FRAME	SPEED (RPM) min-1	INPUT CURRENT (I) 380-480V A	DATA RELATED TO 460V						
					In	POWER FACTOR cos (φ)	Tn lb.ft	*PDS EFFICIENCY η%			
					A			100	75	50	
4.0	EXM143- 145/4.040BH2	143-145	3000	6.7-5.3	5.4	0.80	7.04	87.6	87.5	86.0	
			3600		5.3			5.87	88.0	87.4	85.4
			4000		5.3			5.28	88.1	87.1	84.9
5.5	EXM143- 145/4.055BH2		3000	7.7-6.6	6.8	0.86	9.39	87.3	87.7	87.5	
			3600		6.6			7.83	89.1	88.8	87.3
			4000		6.5			7.04	89.1	88.5	86.8
7.5	EXM143- 145/4.075BH2		3000	10.2-8.4	8.6	0.89	12.91	89.9	89.9	89.2	
			3600		8.6			10.76	89.7	89.5	88.5
			4000		8.4			9.68	90.5	89.4	87.4

hydrovar X ELECTRICAL DATA

Table 4: 143-145 Frame High Speed, 200-240V

Pn HP	MOTOR TYPE	NEMA FRAME	SPEED (RPM) min-1	INPUT CURRENT (I) 200-240V A	DATA RELATED TO 230V					
					In A	POWER FACTOR cos (φ)	Tn lb.ft	*PDS EFFICIENCY η%		
								100	75	50
4.0	EXM143- 145/3.040BH2	143-145	3000	10.7-8.9	-	0.94	-	-	-	-
			3600		9.2		5.87	87.2	87.1	85.9
			4000		9.1		5.28	88.0	87.8	86.4
5.5	EXM143- 145/3.055BH2		3000	Unavailable						
			3600	Unavailable						
			4000	Unavailable						
7.5	EXM143- 145/3.075BH2		3000	Unavailable						
			3600	Unavailable						
			4000	Unavailable						

Table 5: 213-215 Frame, High Speed, 380-480V

Pn HP	MOTOR TYPE	NEMA FRAME	SPEED (RPM) min-1	INPUT CURRENT (I) 380-480V A	DATA RELATED TO 460V					
					In A	POWER FACTOR cos (φ)	Tn lb.ft	*PDS EFFICIENCY η%		
								100	75	50
7.50	EXM213- 215/4.075CH2	213-215	3000	11.4-11.0	11.1	0.72	12.92	90.5	90.1	88.8
			3600		10.6		10.76	90.8	90.1	88.5
			4000		10.6		9.68	90.5	89.5	87.4
10.0	EXM213- 215/4.100CH2		3000	14.4-12.5	12.2	0.85	17.61	90.8	90.1	88.4
			3600		12.4		14.67	90.2	89.2	87.0
			4000		12.0		13.20	90.6	89.5	87.1
15.0	EXM213- 215/4.150CH2		3000	20.3-16.5	16.8	0.90	25.82	91.2	90.7	89.3
			3600		16.9		21.52	91.1	90.5	89.1
			4000		17.0		19.37	90.6	90.2	88.4

Table 6: 213-215 Frame, High Speed, 200-240V

Pn HP	MOTOR TYPE	NEMA FRAME	SPEED (RPM) min-1	INPUT CURRENT (I) 200-240V A	DATA RELATED TO 230V					
					In A	POWER FACTOR cos (φ)	Tn lb.ft	*PDS EFFICIENCY η%		
								100	75	50
7.50	EXM213- 215/3.075CH2	213-215	3000	18.9-16.2	16.7	0.94	12.92	89.6	89.3	88.2
			3600		16.3		10.76	89.9	89.2	87.6
			4000		16.6		9.68	88.6	87.6	85.1
10.0	EXM213- 215/3.100CH2		3000	Unavailable						
			3600	Unavailable						
			4000	Unavailable						
15.0	EXM213- 215/3.150CH2		3000	Unavailable						
			3600	Unavailable						
			4000	Unavailable						

hydrovar X ELECTRICAL DATA

Table 7: 254-256 Frame, High Speed, 380-480V

Pn HP	MOTOR TYPE	NEMA FRAME	SPEED (RPM) min-1	INPUT CURRENT (I) 380-480V A	DATA RELATED TO 460V					
					In A	POWER FACTOR cos (φ)	Tn lb.ft	*PDS EFFICIENCY η%		
								100	75	50
15.00	EXM254- 256/4.150DH2	254-256	3000	24.5-22.8	21.7	0.72	25.82	91.7	91.2	90.2
			3600		20.9		21.52	92.0	91.2	89.9
			4000		20.5		19.37	91.5	90.6	88.8
20.0	EXM254- 256/4.200DH2		3000	30.2-27.1	24.5	0.76	35.22	91.5	91.2	90.1
			3600		27.0		29.35	92.1	91.4	90.1
			4000		26.8		26.41	91.8	91.1	89.6
25.0	EXM254- 256/4.250DH2		3000	33.5-28.6	29.4	0.87	43.44	91.7	91.4	90.7
			3600		28.9		36.19	92.1	91.5	90.4
			4000		28.8		32.58	92.0	91.4	90.2
30.0	EXM254- 256/4.300DH2		3000	38.9-32.4	33.5	0.90	51.65	92.1	91.7	90.7
			3600		33.3		43.04	92.5	91.8	90.6
			4000		32.7		38.83	92.4	91.6	90.2

Table 8: 254-256 Frame, High Speed, 200-240V

Pn HP	MOTOR TYPE	NEMA FRAME	SPEED (RPM) min-1	INPUT CURRENT (I) 200-240V A	DATA RELATED TO 230V						
					In A	POWER FACTOR cos (φ)	Tn lb.ft	*PDS EFFICIENCY η%			
								100	75	50	
15.00	EXM254- 256/3.150DH2	254-256	3000	38.4-34.1	35.4	0.90	25.82	90.3	90.3	89.4	
			3600		33.7		21.52	91.2	90.8	89.7	
			4000		32.5		19.37	91.3	90.6	89.3	
20.0	EXM254- 256/3.200DH2		-	50.0-44.1	-	0.92	-	-	-	-	
			3600		44.9		29.35	91.1	90.6	89.5	
			4000		44.4		26.41	90.3	89.4	87.5	
25.0	EXM254- 256/3.250DH2		3000	-	-	-	-	-	-	-	
			3600								Unavailable
			4000								
30.0	EXM254- 256/3.300DH2		3000	-	-	-	-	-	-	-	
			3600								Unavailable
			4000								

Table 9: 56 Frame, Low Speed, 380-480V

Pn HP	MOTOR TYPE	NEMA FRAME	SPEED (RPM) min-1	INPUT CURRENT (I) 380-480V A	DATA RELATED TO 460V					
					In A	POWER FACTOR cos (φ)	Tn lb.ft	*PDS EFFICIENCY η%		
								100	75	50
2.0	EXM56/4.020BH4	56	1500	4.0-3.8	3.70	0.57	7.04	82.2	83.2	83.0
			1800		3.90		5.87	85.1	85.9	85.6
			2000		3.50		5.28	86.7	86.4	85.3
3.0	EXM56/4.030BH4		1500	5.0-4.6	4.70	0.69	10.33	85.6	85.8	84.9
			1800		4.60		8.61	88.0	87.6	86.5
			2000		4.50		7.74	89.0	88.6	87.3

hydrovar X ELECTRICAL DATA

Table 10: HX-B-LS-LV

Pn HP	MOTOR TYPE	NEMA FRAME	SPEED (RPM) min-1	INPUT CURRENT (I) 200-240V A	DATA RELATED TO 230V						
					In A	POWER FACTOR cos (φ)	Tn lb.ft	*PDS EFFICIENCY η%			
								100	75	50	
2.0	EXM56/3.020BH4	56	1500	5.7-4.9	5.1	0.89	7.04	83.2	83.8	83.5	
			1800		4.9			5.87	85.7	85.9	85.3
			2000		4.9			5.28	86.5	85.7	83.6
3.0	EXM56/3.030BH4		1500	7.9-6.7	7.00	0.93	10.33	86.0	86.3	86.2	
			1800		6.80			8.63	87.9	87.7	86.8
			2000		6.70			7.74	88.9	88.9	87.9

Table 11: HX-B-LS-HV

Pn HP	MOTOR TYPE	NEMA FRAME	SPEED (RPM) min-1	INPUT CURRENT (I) 380-480V A	DATA RELATED TO 460V						
					In A	POWER FACTOR cos (φ)	Tn lb.ft	*PDS EFFICIENCY η%			
								100	75	50	
2.0	EXM143- 145/4.020BH4	143-145	1500	4.0-3.8	3.70	0.57	7.04	82.2	83.2	83.0	
			1800		3.90			5.87	85.1	85.9	85.6
			2000		3.50			5.28	86.7	86.4	85.3
3.0	EXM143- 145/4.030BH4		1500	5.0-4.6	4.70	0.69	10.33	85.6	85.8	84.9	
			1800		4.60			8.61	88.0	87.6	86.5
			2000		4.50			7.74	89.0	88.6	87.3

Table 12: 143-145 Frame, Low Speed, 200-240V

Pn HP	MOTOR TYPE	NEMA FRAME	SPEED (RPM) min-1	INPUT CURRENT (I) 200-240V A	DATA RELATED TO 230V						
					In A	POWER FACTOR cos (φ)	Tn lb.ft	*PDS EFFICIENCY η%			
								100	75	50	
2.0	EXM143- 145/3.020BH4	143-145	1500	5.7-4.9	5.1	0.89	7.04	83.2	83.8	83.5	
			1800		4.9			5.87	85.7	85.9	85.3
			2000		4.9			5.28	86.5	85.7	83.6
3.0	EXM143- 145/3.030BH4		1500	7.9-6.7	7.00	0.93	10.33	86.0	86.3	86.2	
			1800		6.80			8.63	87.9	87.7	86.8
			2000		6.70			7.74	88.9	88.9	87.9

Table 13: HX-C-LS-HV

Pn HP	MOTOR TYPE	NEMA FRAME	SPEED (RPM) min-1	INPUT CURRENT (I) 380-480V A	DATA RELATED TO 460V						
					In A	POWER FACTOR cos (φ)	Tn lb.ft	*PDS EFFICIENCY η%			
								100	75	50	
4.0	EXM213- 215/4.040CH4	213-215	1500	7.9-7	7.2	0.62	14.09	86.3	86.6	85.7	
			1800		6.9			11.73	88.1	87.9	86.8
			2000		7			10.55	88.5	88.2	87.1
5.5	EXM213- 215/4.055CH4		1500	9.2-8.5	8.9	0.66	18.78	89.4	89.4	88.8	
			1800		8.4			15.65	91.2	91.1	90.4
			2000		8.3			14.09	91.6	91.5	90.8
7.5	EXM213- 215/4.075CH4		1500	11.2-10.2	10.3	0.75	25.82	90.7	90.8	90.4	
			1800		10.1			21.52	91.6	91.8	90.6
			2000		10.1			19.37	91.6	91.3	90.5

hydrovar X ELECTRICAL DATA

Table 14: HX-C-LS-LV

Pn HP	MOTOR TYPE	NEMA FRAME	SPEED (RPM) min-1	INPUT CURRENT (I) 200-240V A	DATA RELATED TO 230V						
					In	POWER FACTOR cos (φ)	Tn lb.ft	*PDS EFFICIENCY η%			
					A			100	75	50	
4.00	EXM213- 215/3.040CH4	213-215	1500	11.0-9.8	9.9	0.87	14.09	87.2	87.4	87.1	
			1800		9.8			11.73	88.3	88.3	87.7
			2000		9.8			10.55	88.4	88.7	87.7
5.5	EXM213- 215/3.055CH4		1500	14.0-12.3	12.5	0.92	18.81	88.4	88.8	88.7	
			1800		12.2			15.64	89.9	89.8	89.3
			2000		12.1			14.09	90.2	90.4	89.6
7.5	EXM213- 215/3.075CH4		1500	21.6-20.4	16.6	0.93	25.82	89.4	89.7	89.5	
			1800		16.5			21.52	90.2	90.5	90.2
			2000		16.6			19.37	90.1	90.4	90.1

Table 15: 254-256 Frame, Low Speed, 380-480V

Pn HP	MOTOR TYPE	NEMA FRAME	SPEED (RPM) min-1	INPUT CURRENT (I) 380-480V A	DATA RELATED TO 460V						
					In	POWER FACTOR cos (φ)	Tn lb.ft	*PDS EFFICIENCY η%			
					A			100	75	50	
7.50	EXM254- 256/4.075DH4	254-256	1500	15.3-13.6	14.1	0.55	25.82	88.6	88.6	87.9	
			1800		13.8			21.52	90.9	90.7	89.8
			2000		14.3			19.37	91.0	91.1	90.4
10.0	EXM254- 256/4.100DH4		1500	18.7-17.4	17.8	0.60	35.22	89.6	89.9	89.7	
			1800		17.3			29.35	91.0	90.8	89.9
			2000		17.2			26.41	91.3	91.2	90.1
15.0	EXM254- 256/4.150DH4		1500	24.5-22.8	22.9	0.66	51.65	91.1	91.2	90.7	
			1800		22.7			43.04	92.0	91.7	90.8
			2000		22.2			38.74	92.6	92.3	91.4

Table 16: 254-256 Frame, Low Speed, 200-240V

Pn HP	MOTOR TYPE	NEMA FRAME	SPEED (RPM) min-1	INPUT CURRENT (I) 200-240V A	DATA RELATED TO 230V						
					In	POWER FACTOR cos (φ)	Tn lb.ft	*PDS EFFICIENCY η%			
					A			100	75	50	
7.50	EXM254- 256/3.075DH4	254-256	1500	20.5-18.8	19.2	0.83	25.81	88.0	88.4	88.2	
			1800		18.6			21.54	88.9	88.6	87.6
			2000		18			19.40	89.8	89.6	88.8
10.0	EXM254- 256/3.100DH4		1500	27.5-24.8	25.4	0.88	35.22	88.9	89.3	89.1	
			1800		23.5			29.35	90.7	90.7	90.3
			2000		23.3			26.41	91.2	91.2	90.6
15.0	EXM254- 256/3.150DH4		1500	39.0-34.5	35.6	0.9	51.65	89.6	90.1	90.0	
			1800		33.6			43.05	91.1	91.0	90.6
			2000		32.9			38.74	91.5	91.2	90.5

TERMINAL BLOCK hydrovar X

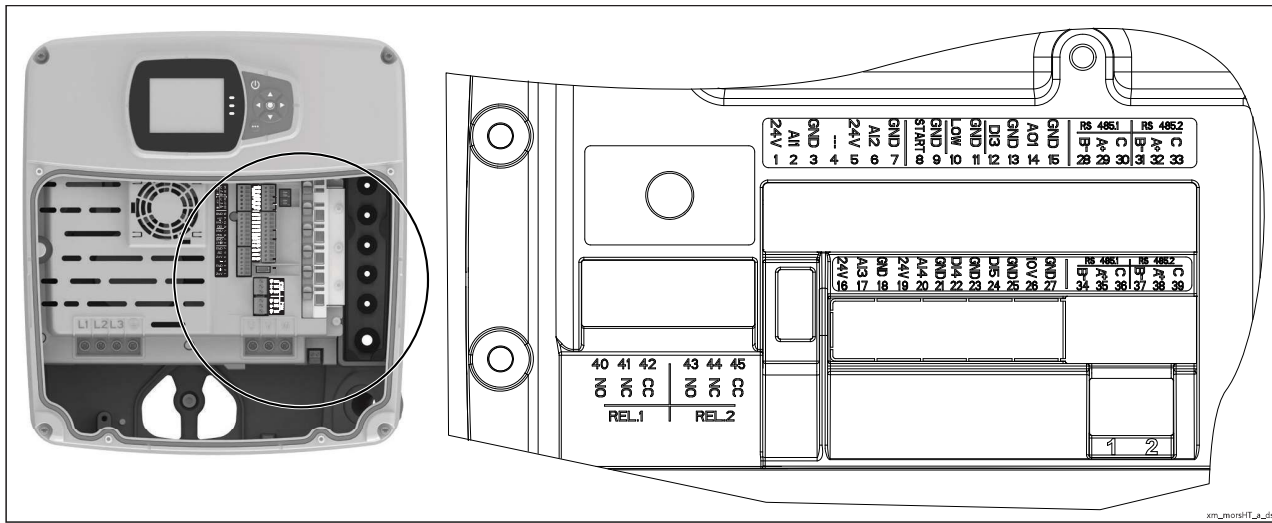

REF.	ITEM	DESCRIPTION	DEFAULT
1		Power supply +24 VDC, max. 60mA (total, terminals 1 + 5)	
2	Analog Input 1	Configurable Analog Input 1	Pressure Sensor 1
3		Electronic GND	
4	Not used	Internal use - Do not connect	
5		Power supply +24 VDC, max. 60mA (total, terminals 1 + 5)	
6	Analog Input 2	Configurable Analog Input 2	Not used
7		Electronic GND	
8	External Start/Stop	Start/Stop digital input, +24 VDC internal pull-up, 6mA contact current	-
9		Electronic GND	
10	External Lack of Water	Low water digital input, +24 VDC internal pull-up, 6mA contact current	-
11		Electronic GND	
12	Digital Input 3	Configurable Digital Input 3, +24 VDC internal pull-up, 6mA contact current	Solo Run
13		Electronic GND	
14	Analog Output	Configurable Analog Output	Motor Speed
15		Electronic GND	
16		Power supply +24 VDC, max. 60mA (total, terminals 16 and 19)	
17	Analog Input 3	Configurable Analog Input 3	Not used
18		Electronic GND	
19		Power supply +24 VDC, max. 60mA (total, terminals 16 and 19)	
20	Analog Input 4	Configurable Analog Input 4	Not used
21		Electronic GND	
22	Digital Input 4	Configurable Digital Input 4, +24 VDC internal pull-up, 6mA contact current	Not used
23		Electronic GND	
24	Digital Input 5	Configurable Digital Input 5, +24 VDC internal pull-up, 6mA contact current	Not used
25		Electronic GND	
26	10 VDC supply	Power supply +10 VDC, max. 3mA	-
27		Electronic GND	
28	Communication bus 1	RS485 port 1: RS485-1B N (-)	Multipump
29		RS485 port 1: RS485-1A P (+)	
30		RS485 port 1: RS485-COM	
31	Communication bus 2	RS485 port 2: RS485-2B N (-)	Modbus
32		RS485 port 2: RS485-2A P (+)	
33		RS485 port 2: RS485-COM	
34	Communication bus 1	RS485 port 1: RS485-1B N (-)	Multipump
35		RS485 port 1: RS485-1A P (+)	
36		RS485 port 1: RS485-COM	
37	Communication bus 2	RS485 port 2: RS485-2B N (-)	Modbus
38		RS485 port 2: RS485-2A P (+)	
39		RS485 port 2: RS485-COM	
40	Relay 1	Configurable relay 1: Normally Open	Running
41		Configurable relay 1: Normally Closed	
42		Configurable relay 1: Common Contact	
43	Relay 2	Configurable relay 2: Normally Open	Error
44		Configurable relay 2: Normally Closed	
45		Configurable relay 2: Common Contact	

HOW TO READ SMART PUMP SERIES CURVES

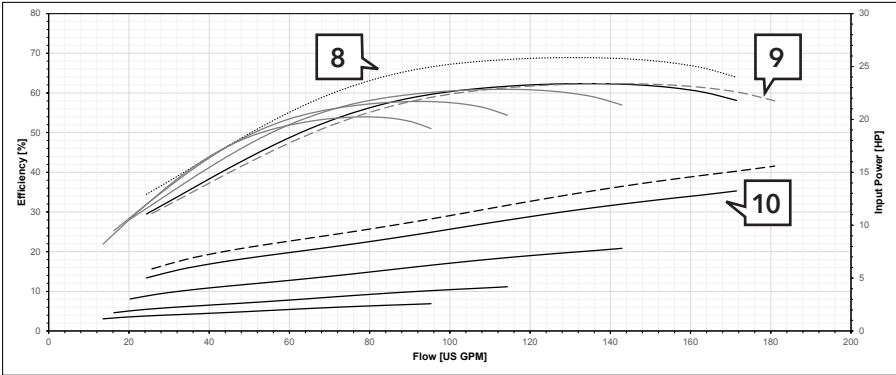
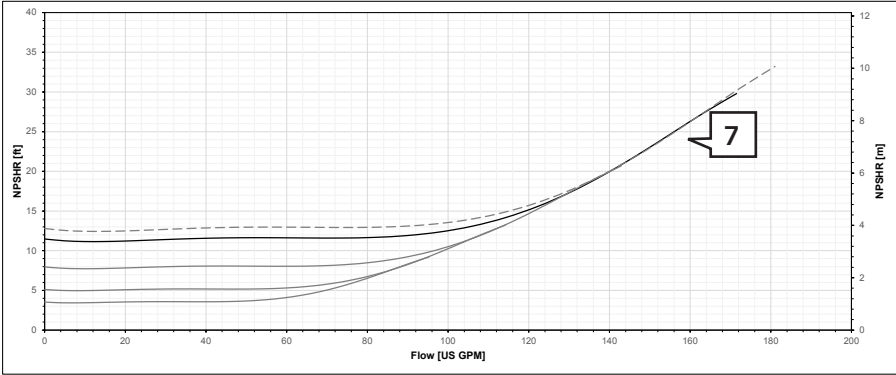
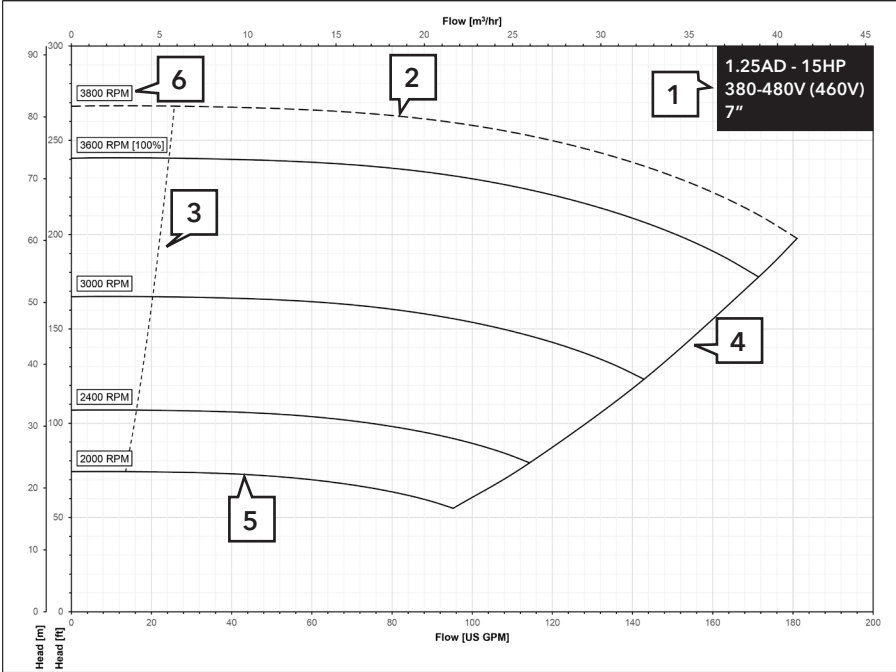

- 1. **Model Information:** pump model and motor information.
- 2. **Maximum Speed Curve:** the maximum operating speed of the pump. Any speed above the nominal speed rating (i.e. 1800 RPM or 3600 RPM) is indicated by a dashed line.
- 3. **Minimum Continuous Stable Flow:** the recommended minimum flow rate of the pump.
- 4. **Maximum Flow Curve:** the recommended maximum flow rate of the pump.
- 5. **Minimum Speed Curve:** the minimum operating speed of the pump for continuous operation.
- 6. **Speed Tags:** indicate the motor speed of a given performance curve. The [100%] modifier indicates the default maximum speed setting of the motor.
- 7. **NPSH Curve:** the net positive suction head required of the pump. The dashed NPSH curve corresponds to the maximum speed condition. The solid black NPSH curve represents the NPSH operating at the [100%] speed. Subsequent NPSH curves represent NPSH required by speed in decreasing order.
- 8. **Pump Efficiency Curve:** the standalone efficiency of the pump operating at the [100%] speed condition.
- 9. **Efficiency Overall:** the overall efficiency (wire-to-water efficiency) of the pump and motor per speed.
- 10. **Input Power:** the input power required to drive the motor by speed.

e-1510X PERFORMANCE CURVES FOR HIGH SPEED MODELS

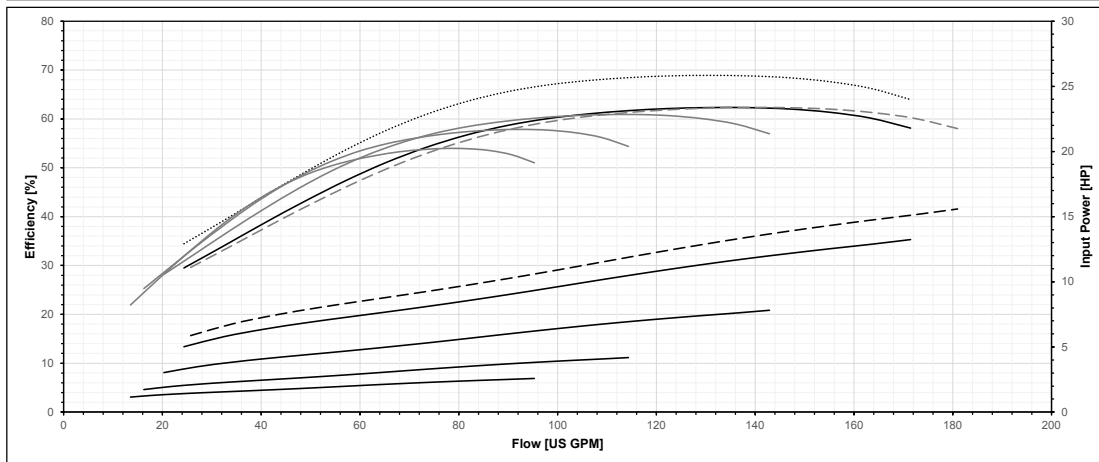
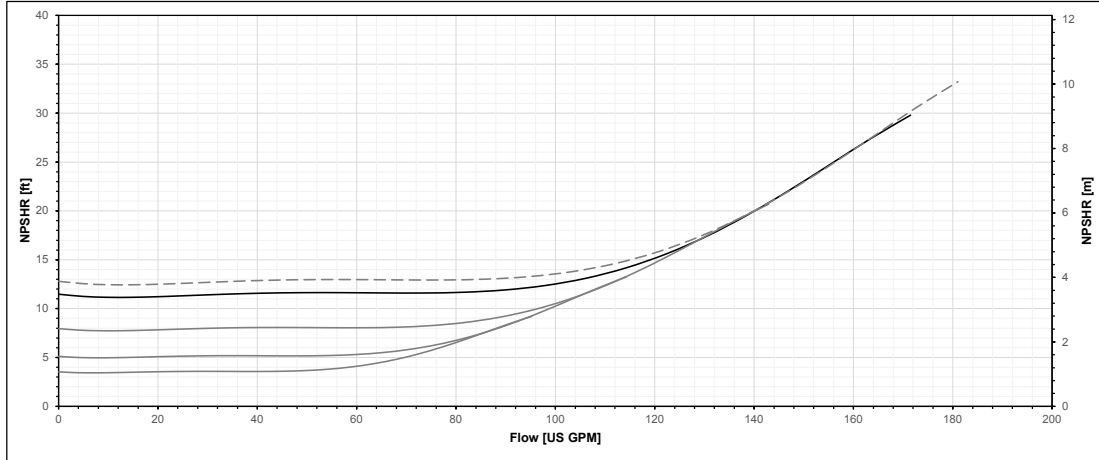
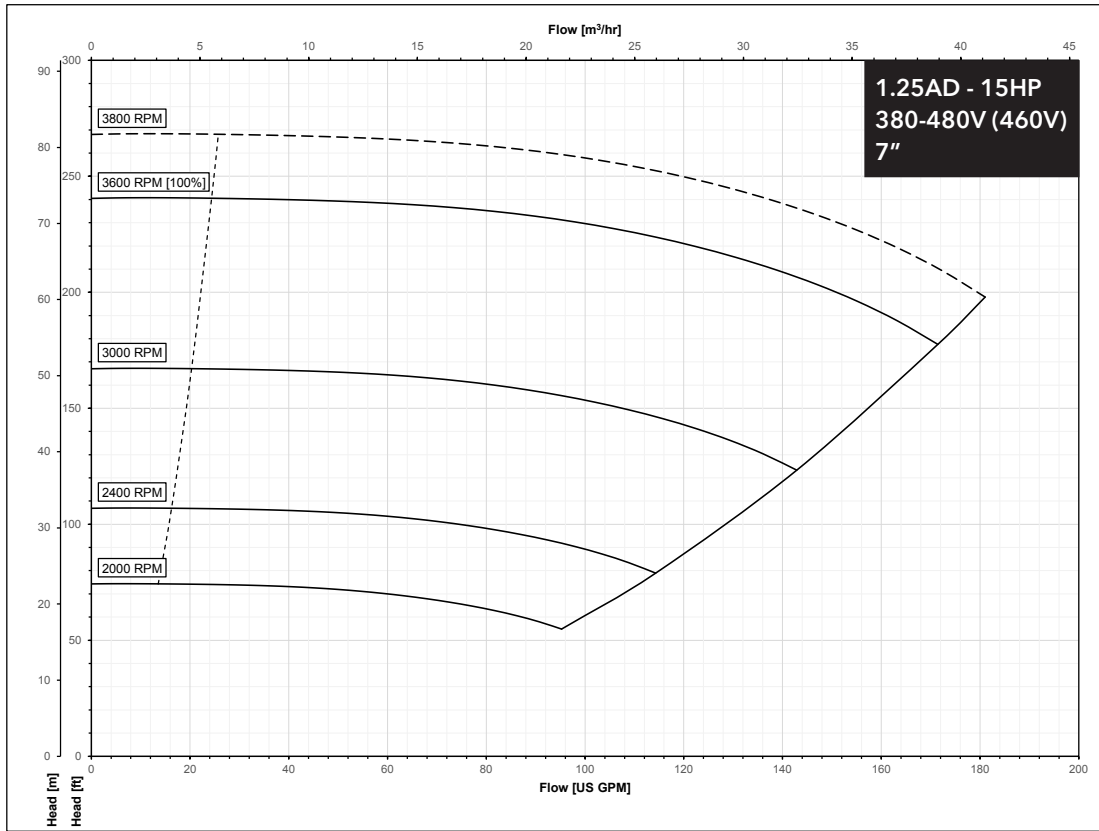

e-1510X PERFORMANCE CURVES FOR HIGH SPEED MODELS

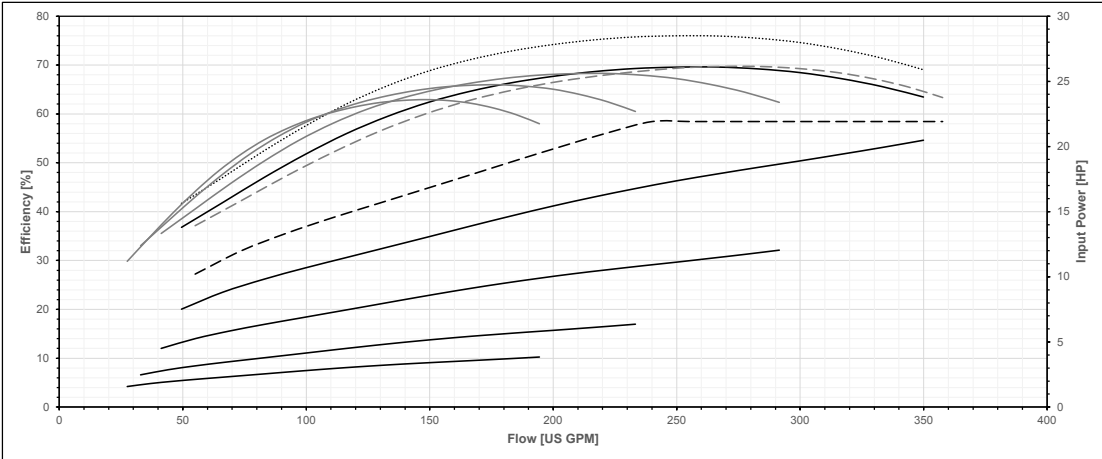
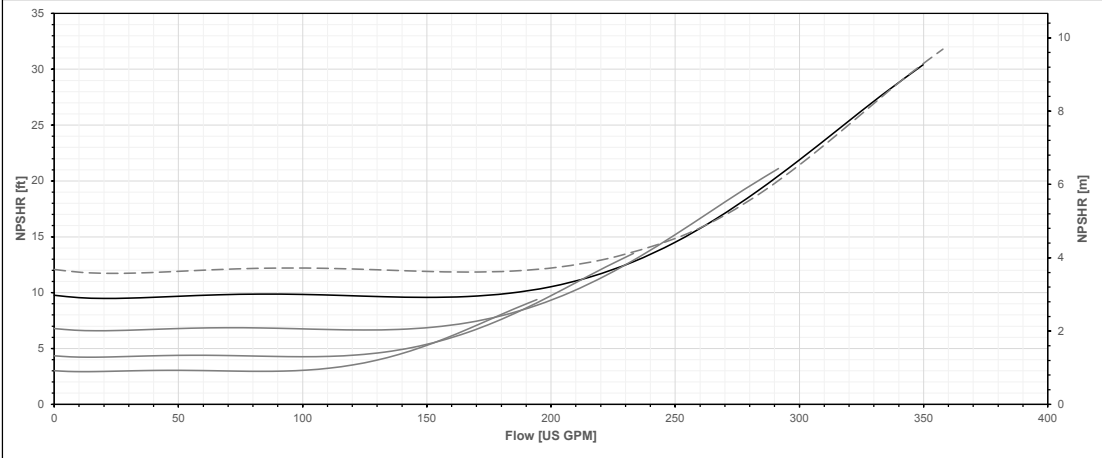
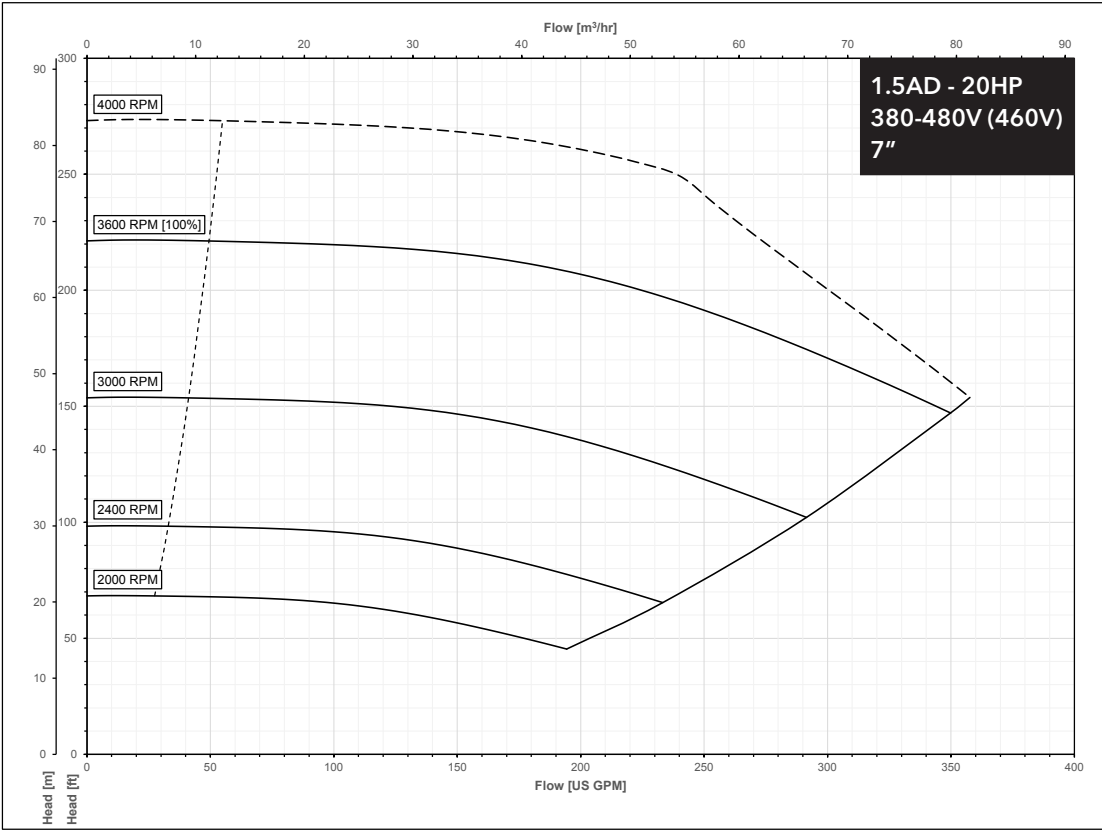

e-1510X PERFORMANCE CURVES FOR HIGH SPEED MODELS

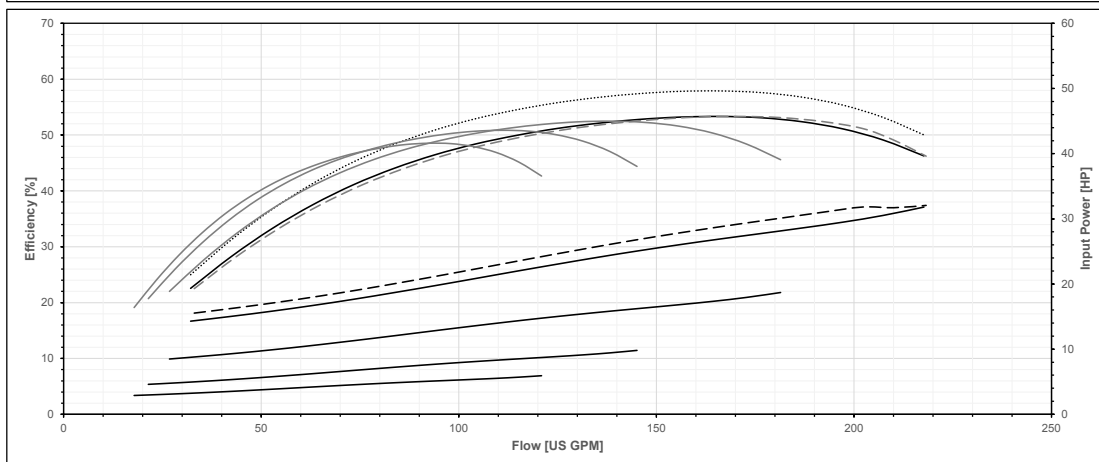
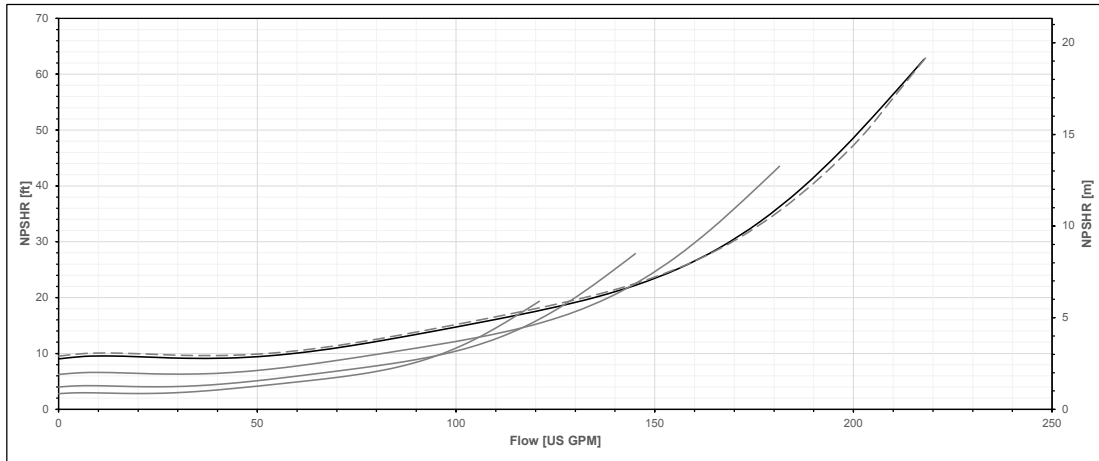
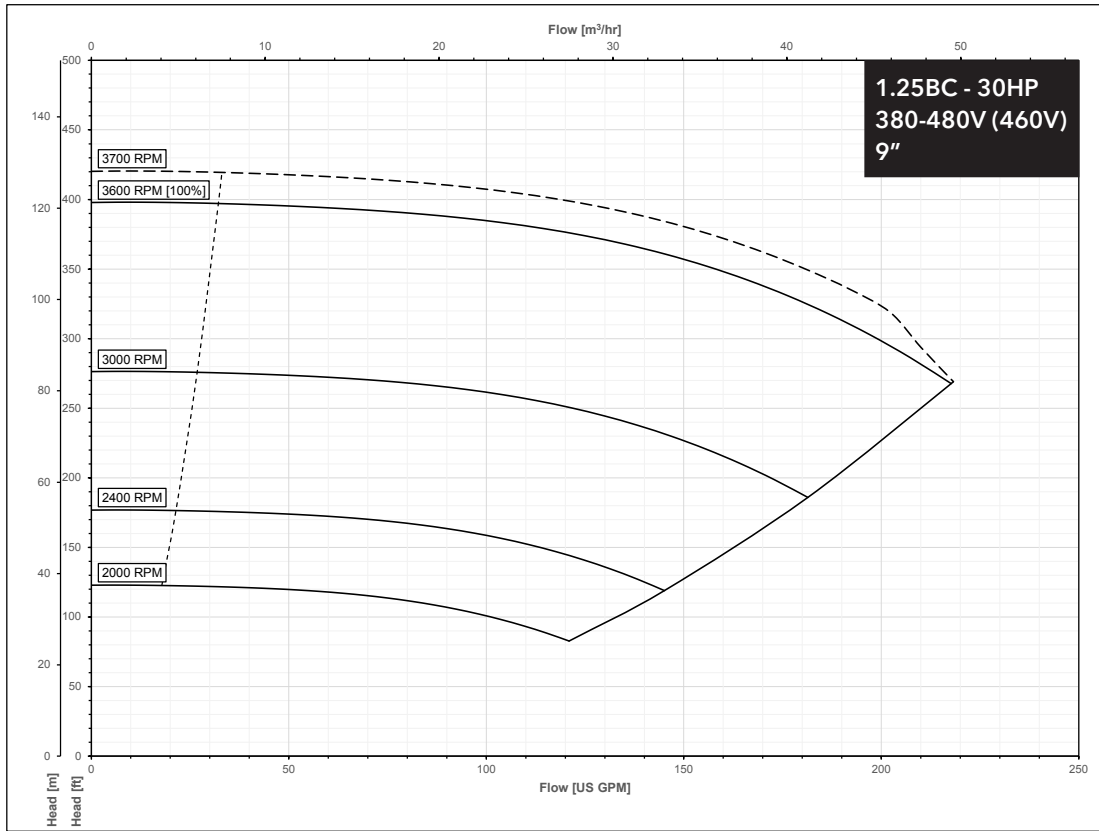

e-1510X PERFORMANCE CURVES FOR HIGH SPEED MODELS

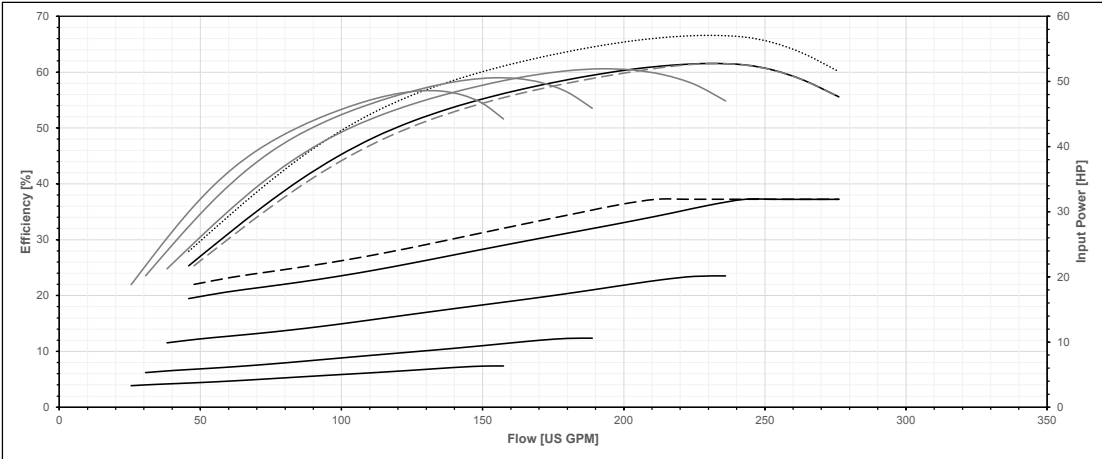
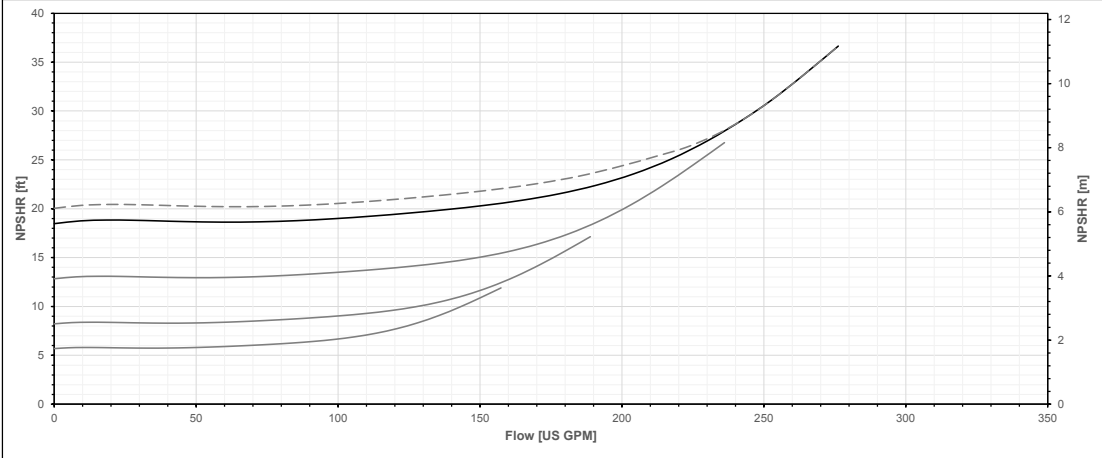
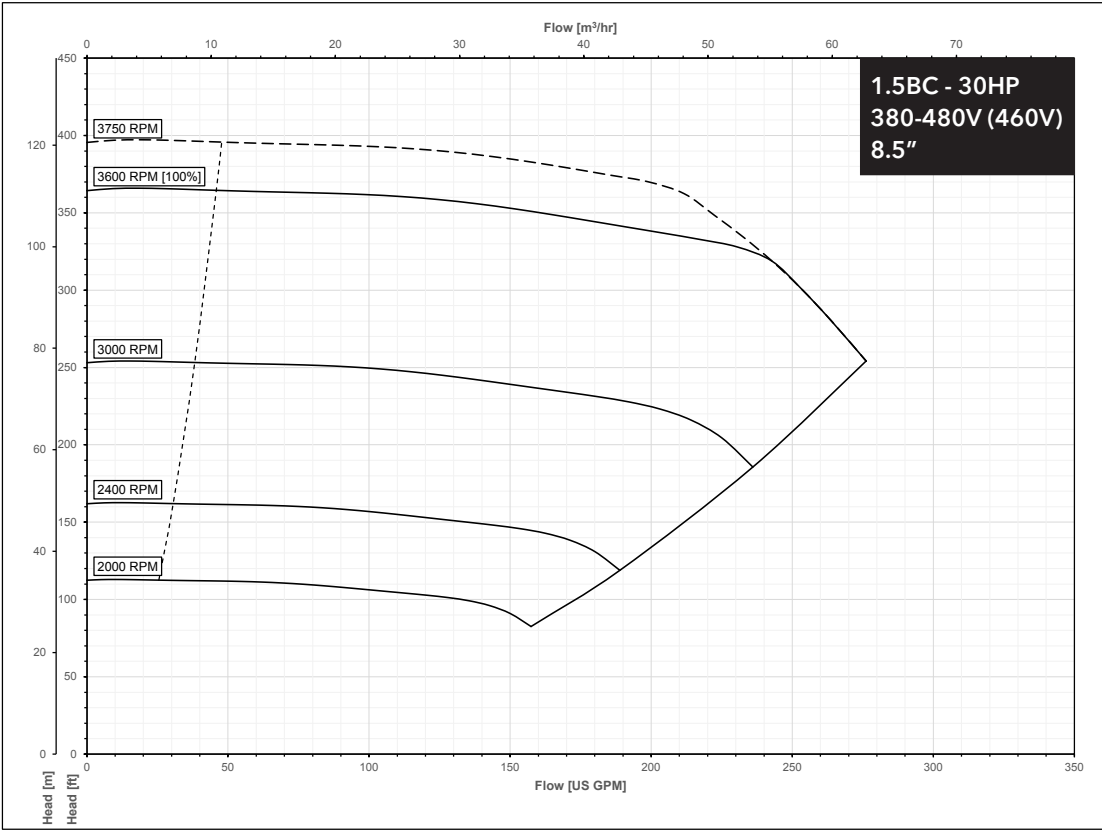

e-1510X PERFORMANCE CURVES FOR HIGH SPEED MODELS

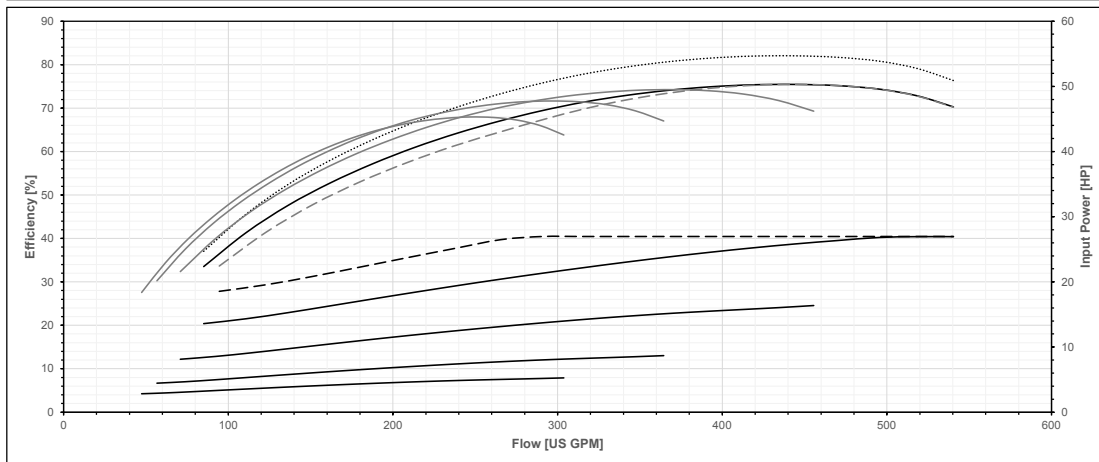
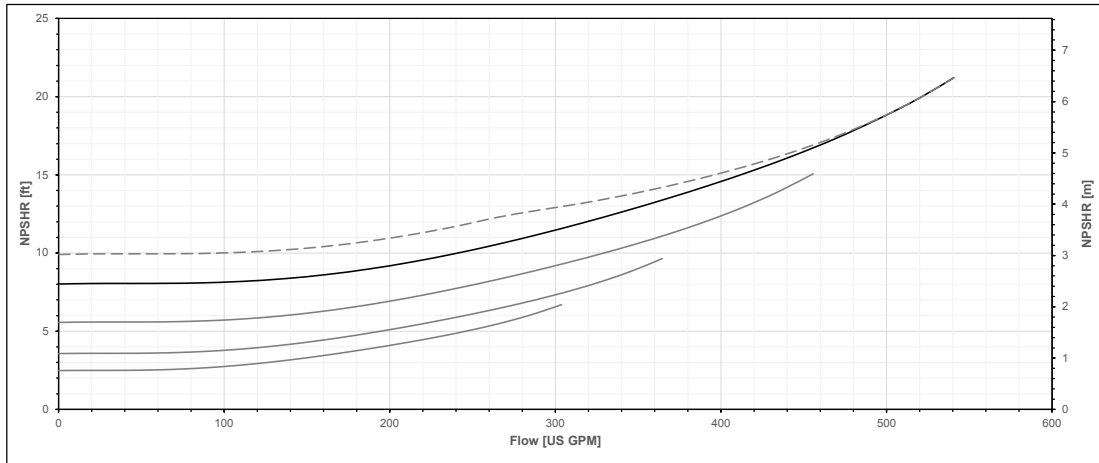
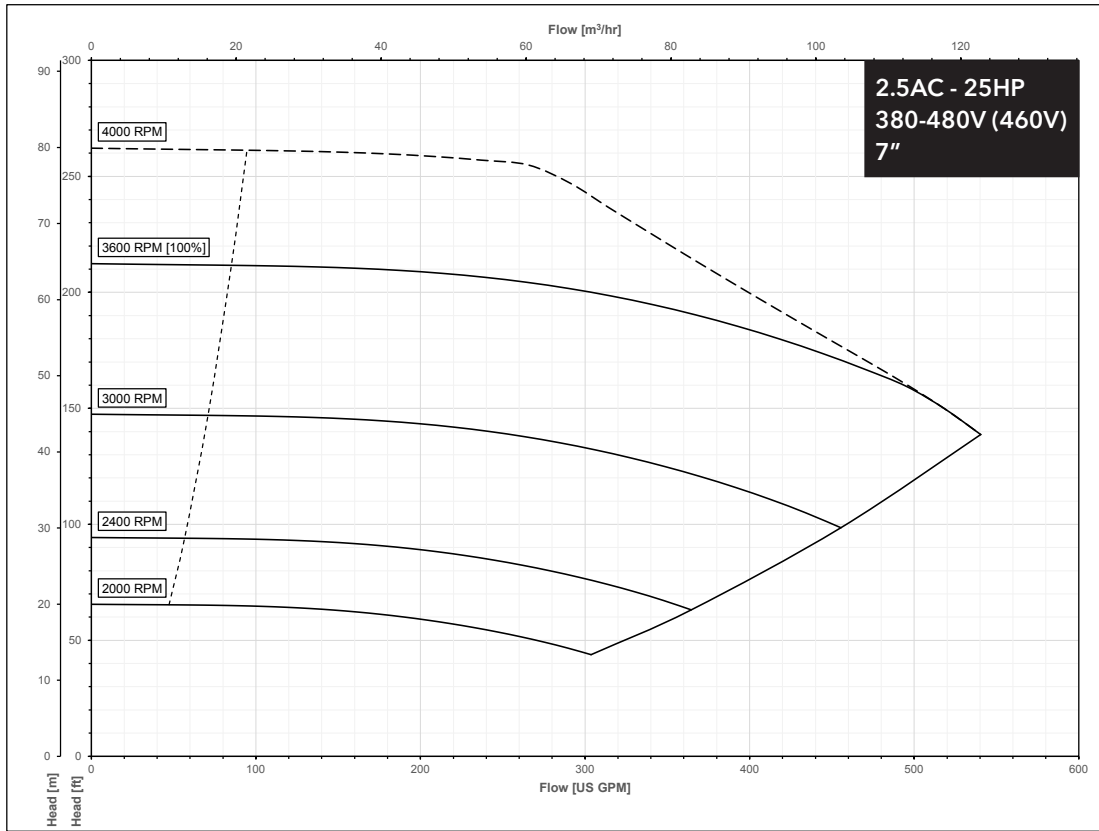

e-1510X PERFORMANCE CURVES FOR HIGH SPEED MODELS

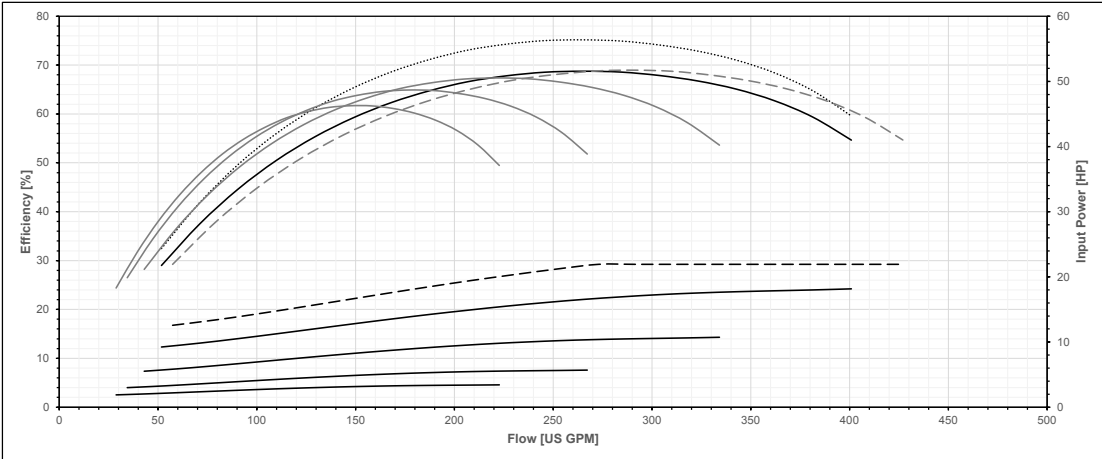
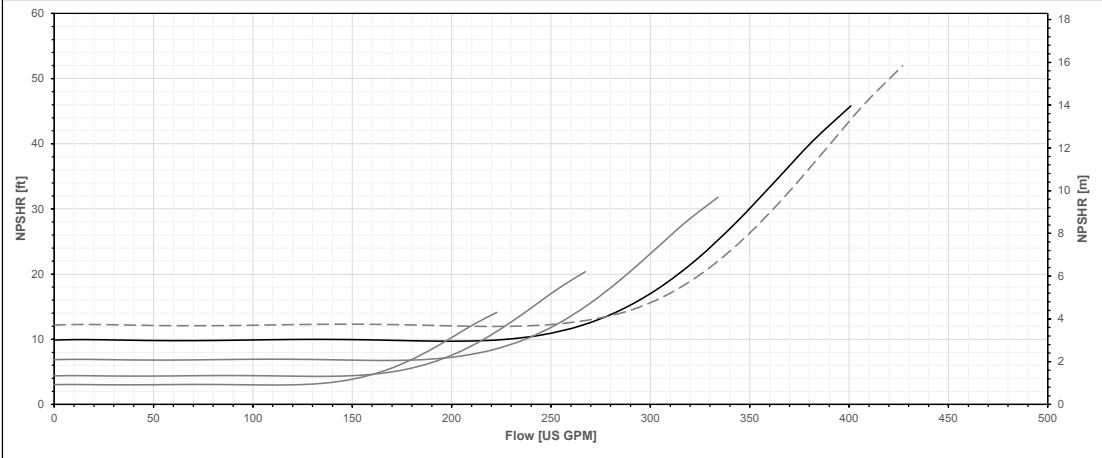
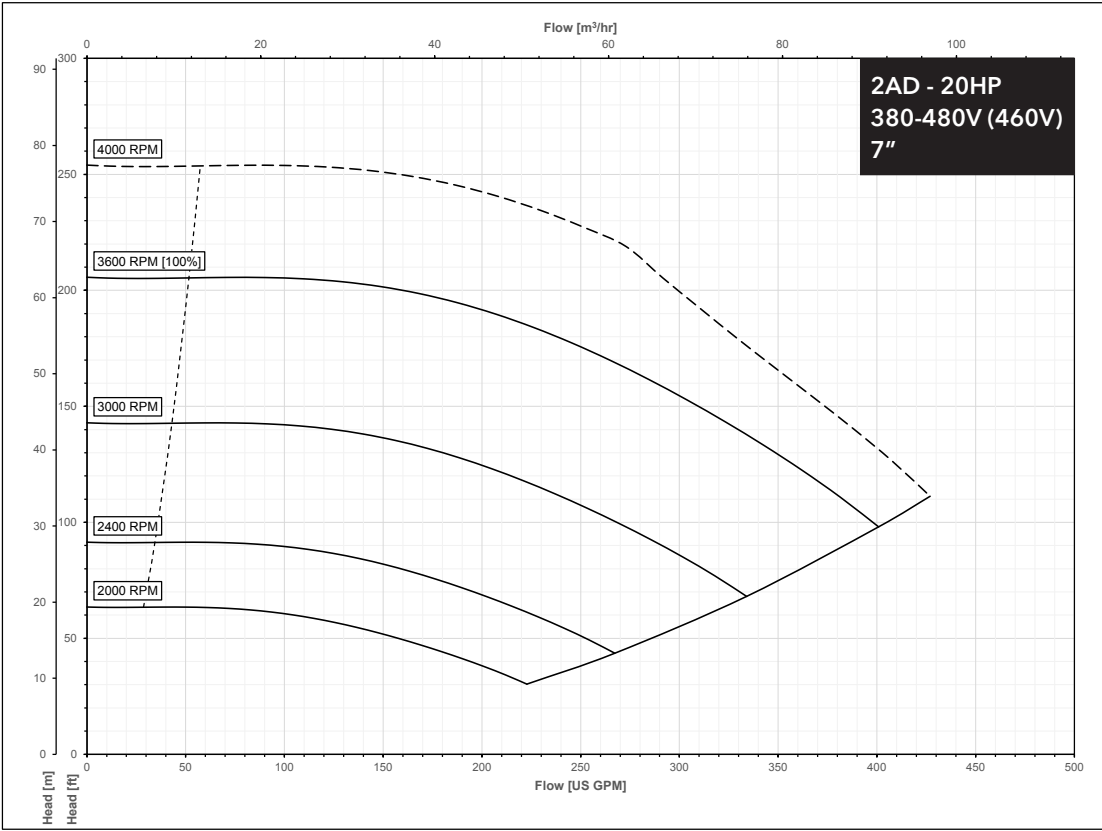

e-1510X PERFORMANCE CURVES FOR HIGH SPEED MODELS

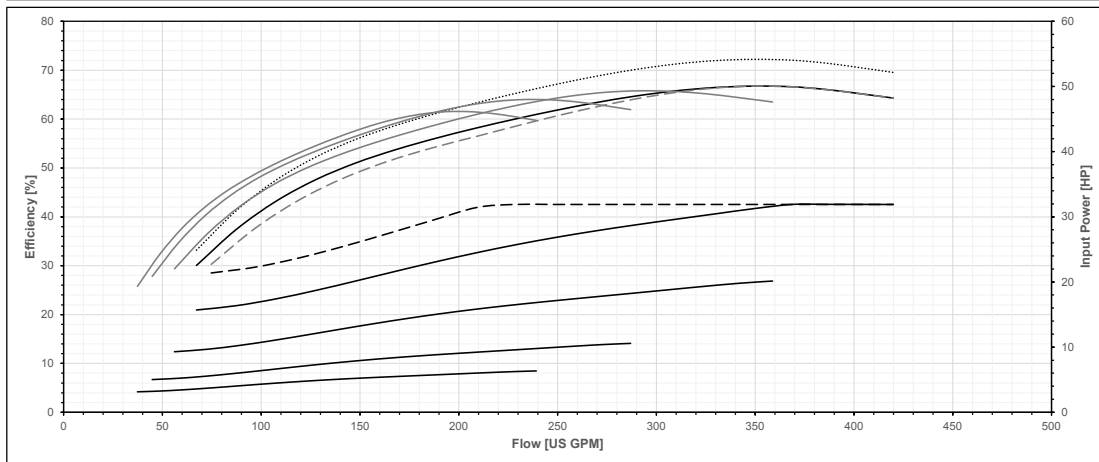
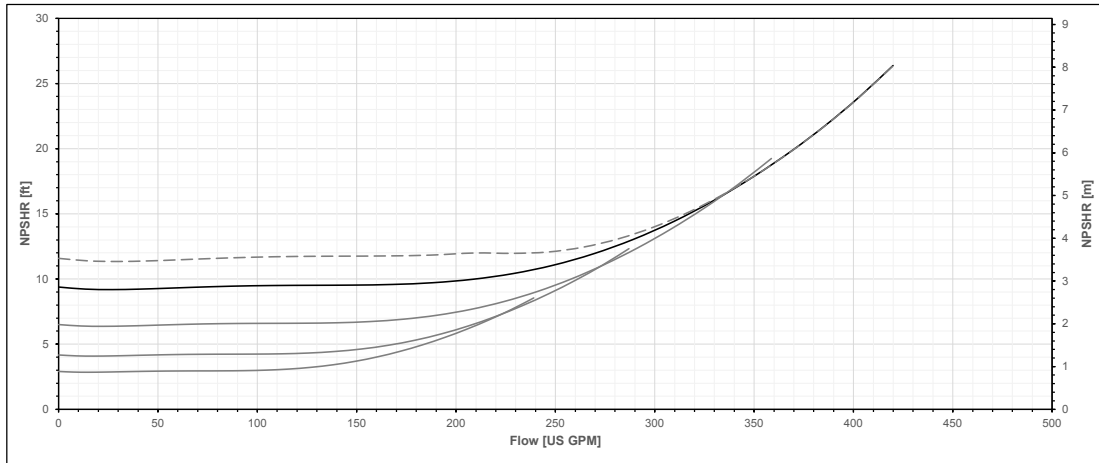
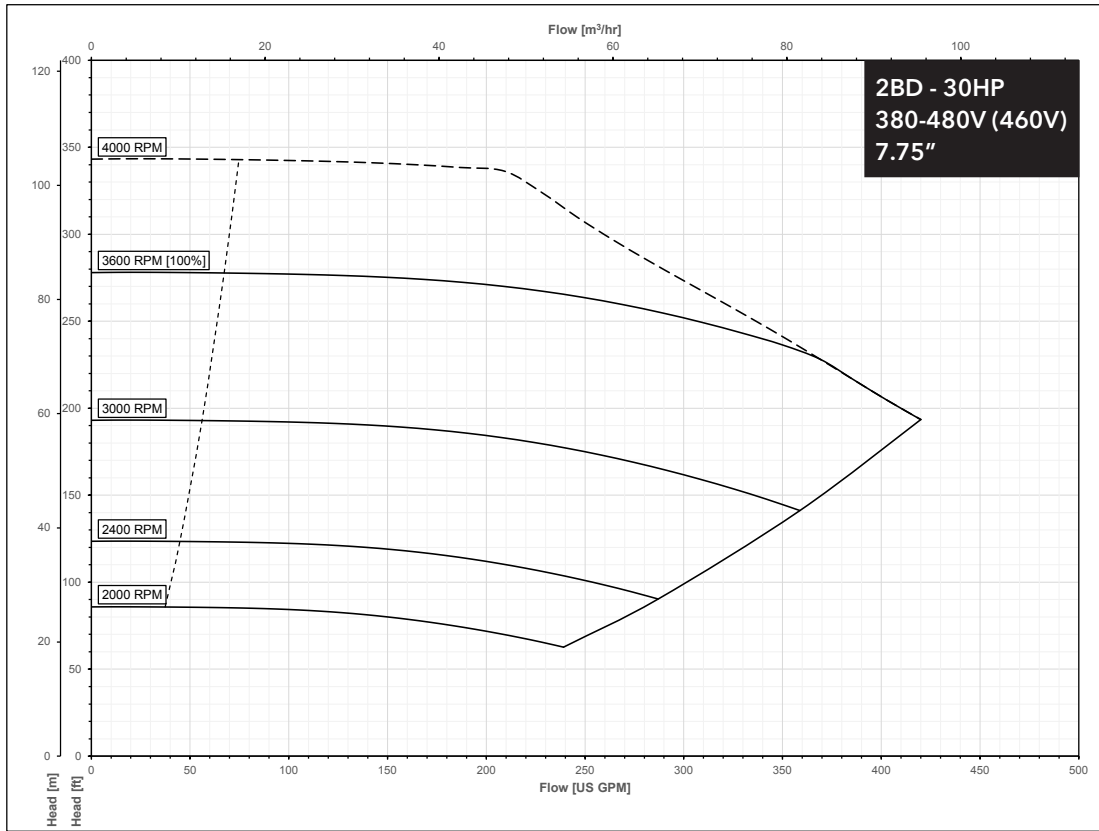

e-1510X PERFORMANCE CURVES FOR HIGH SPEED MODELS

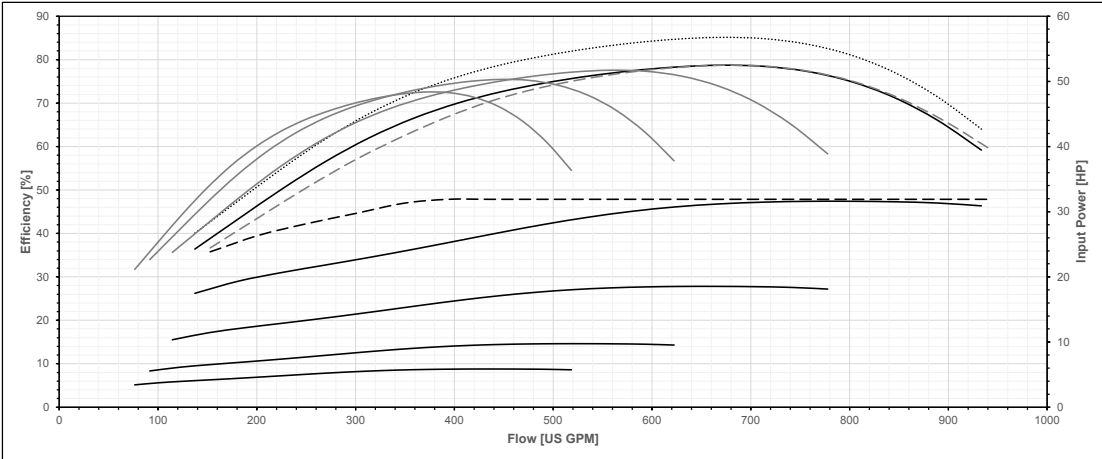
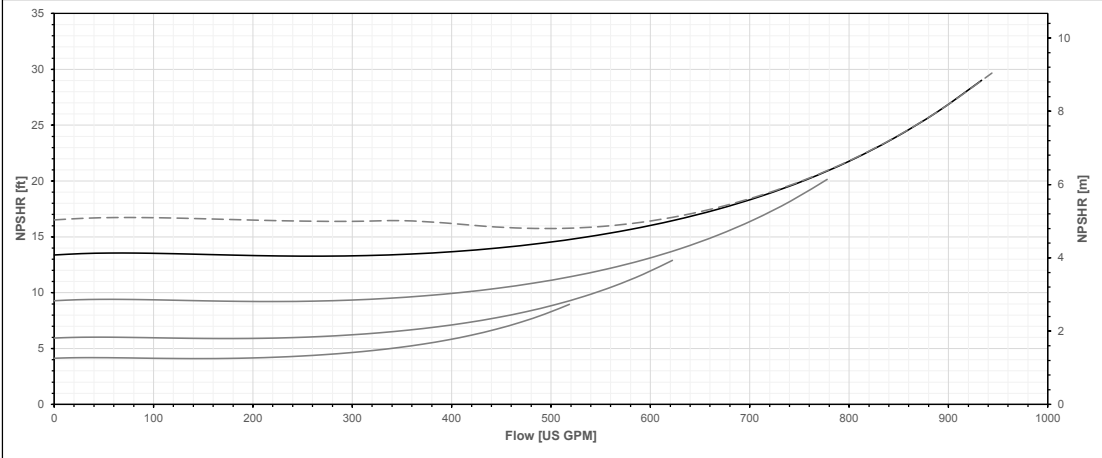
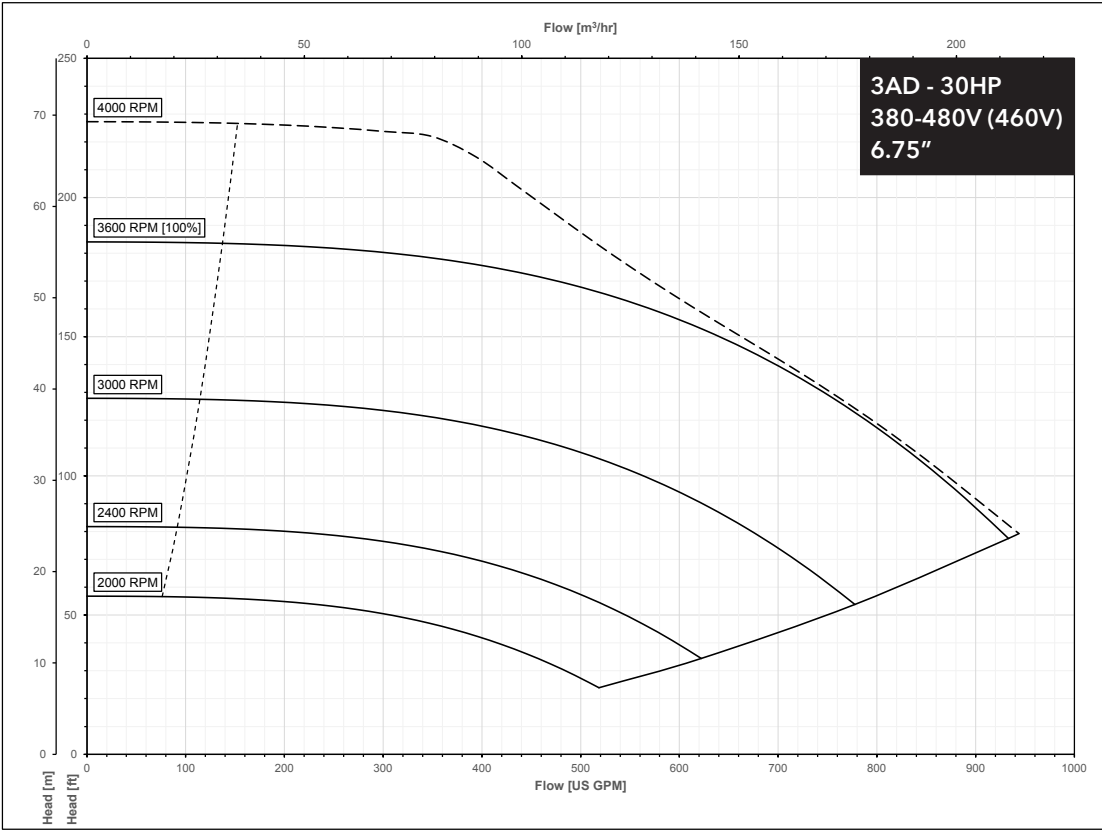

e-1510X PERFORMANCE CURVES FOR HIGH SPEED MODELS

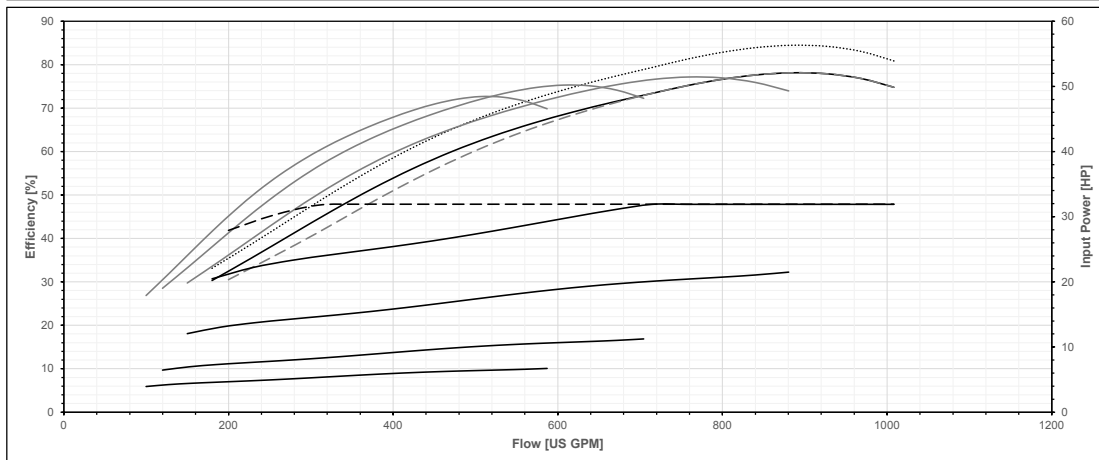
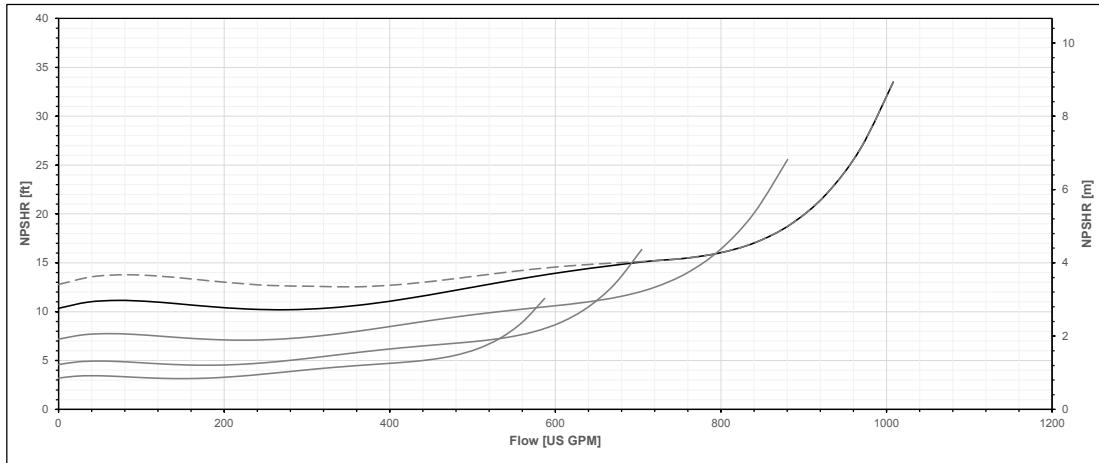
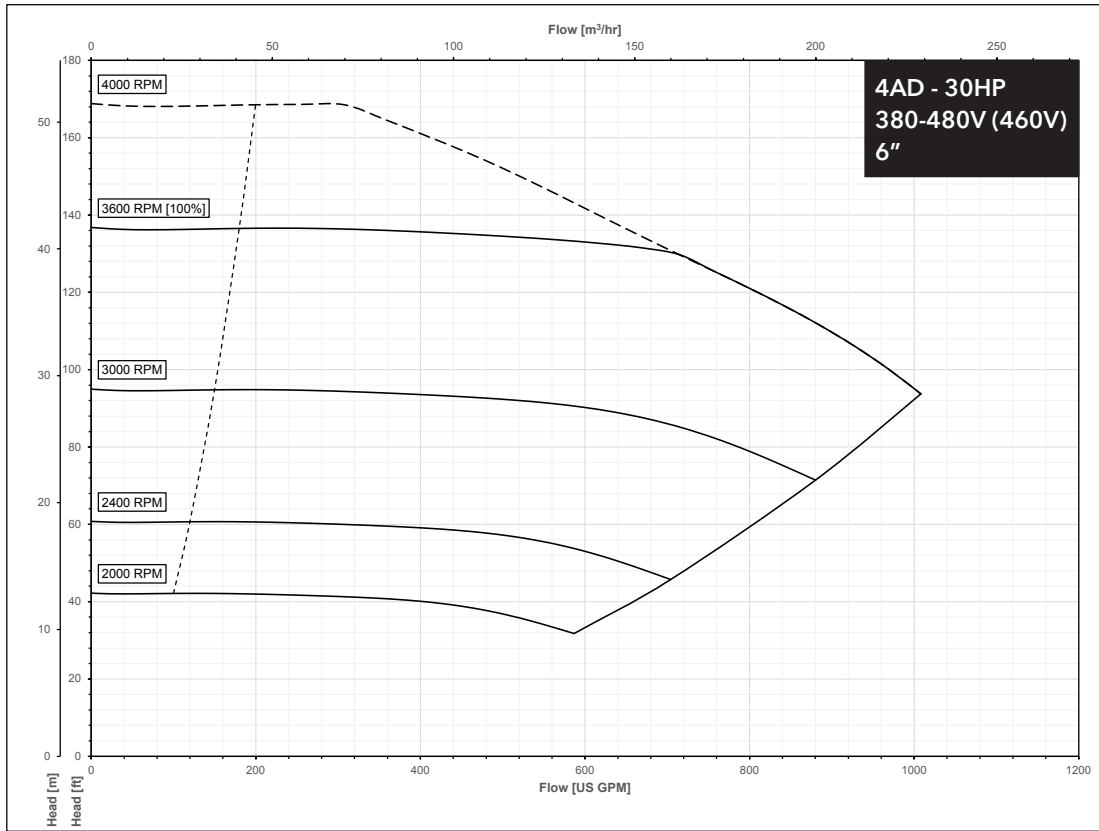

e-1510X PERFORMANCE CURVES FOR HIGH SPEED MODELS

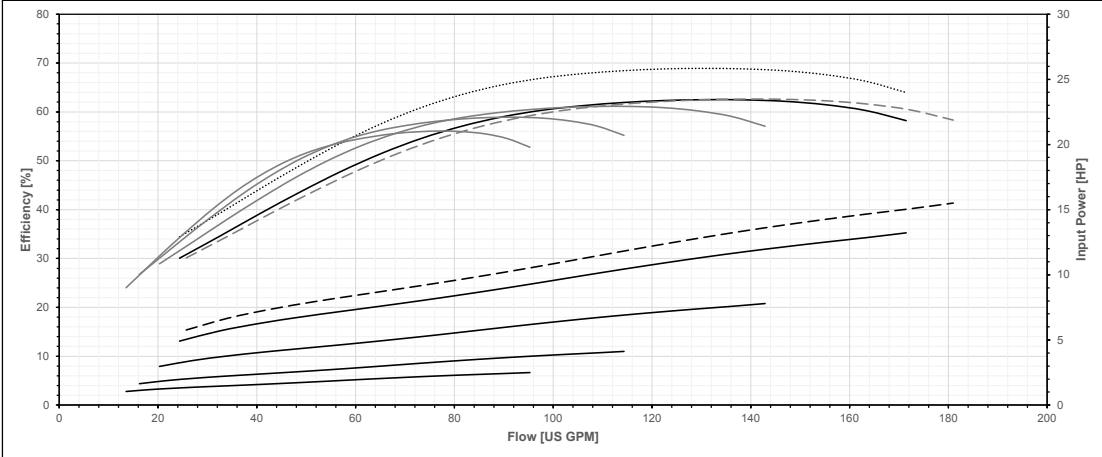
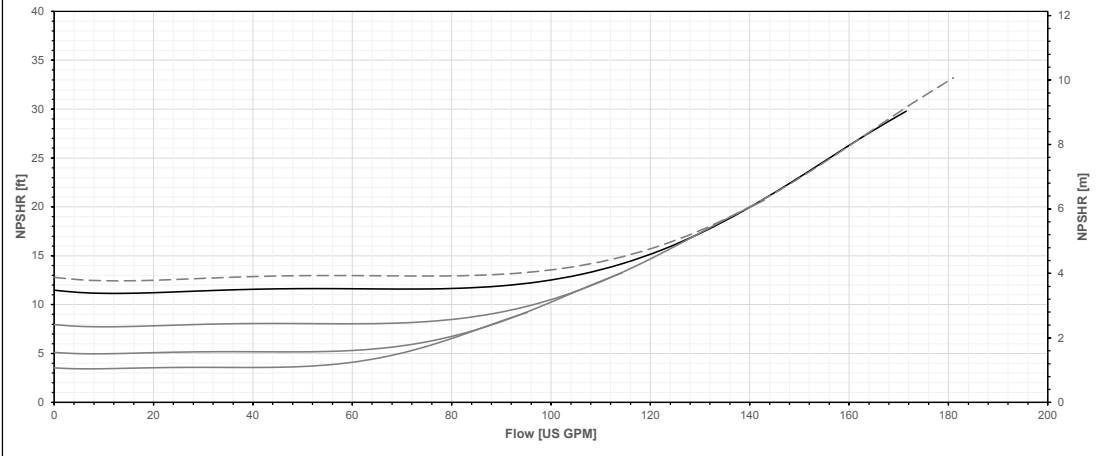
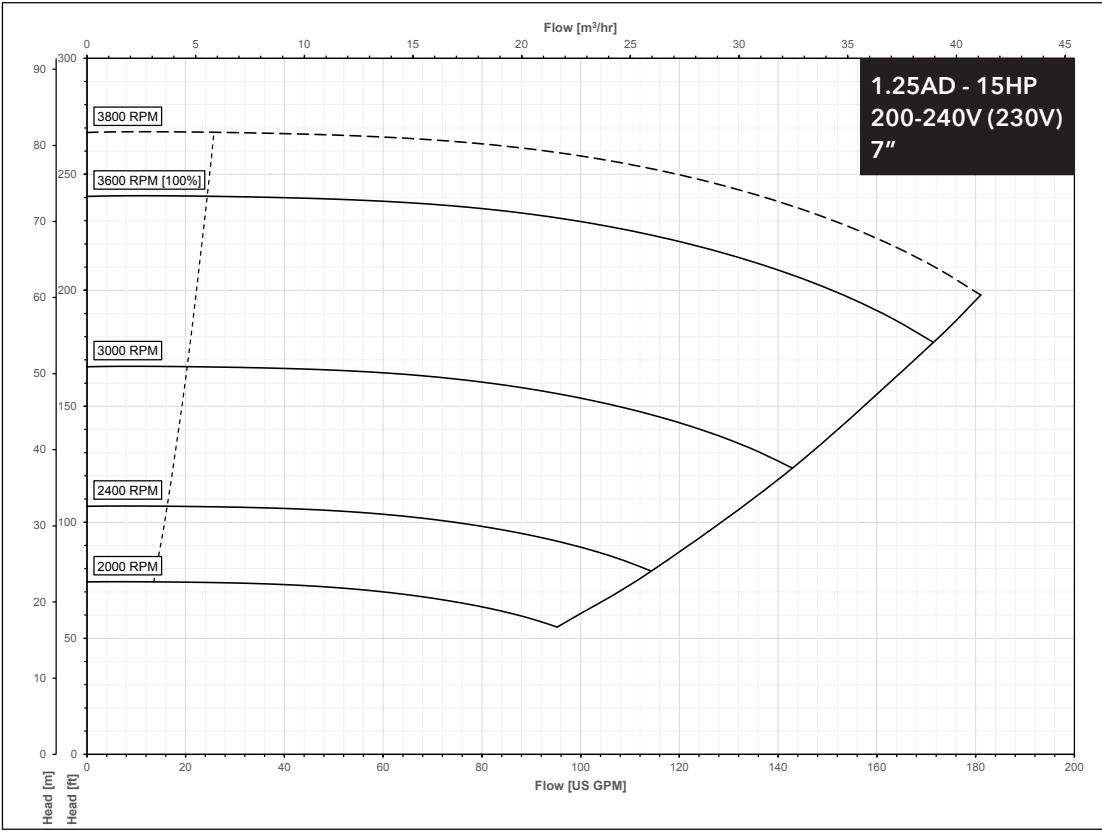

e-1510X PERFORMANCE CURVES FOR HIGH SPEED MODELS

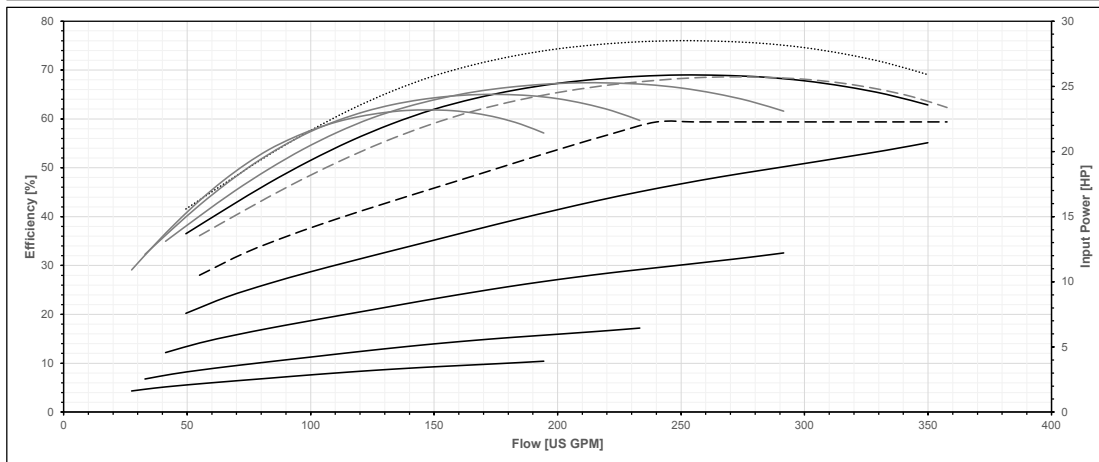
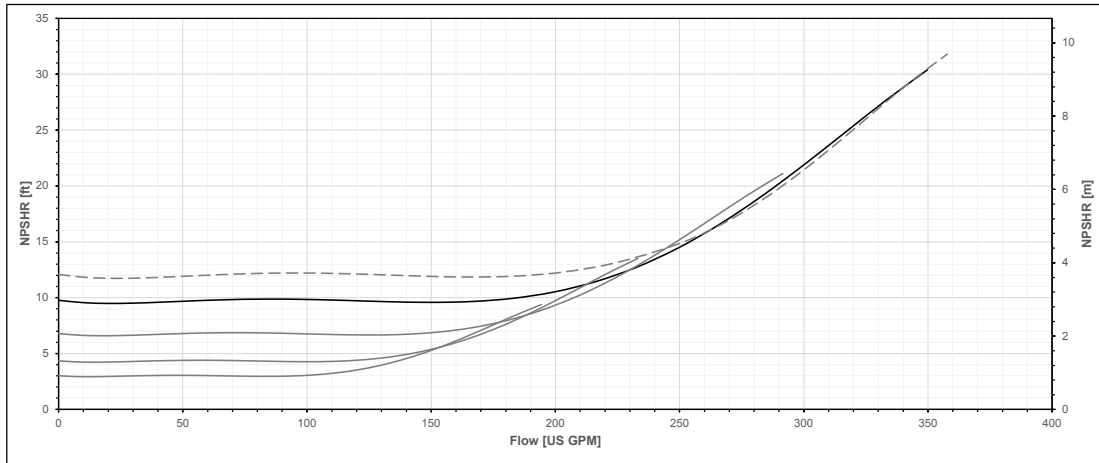
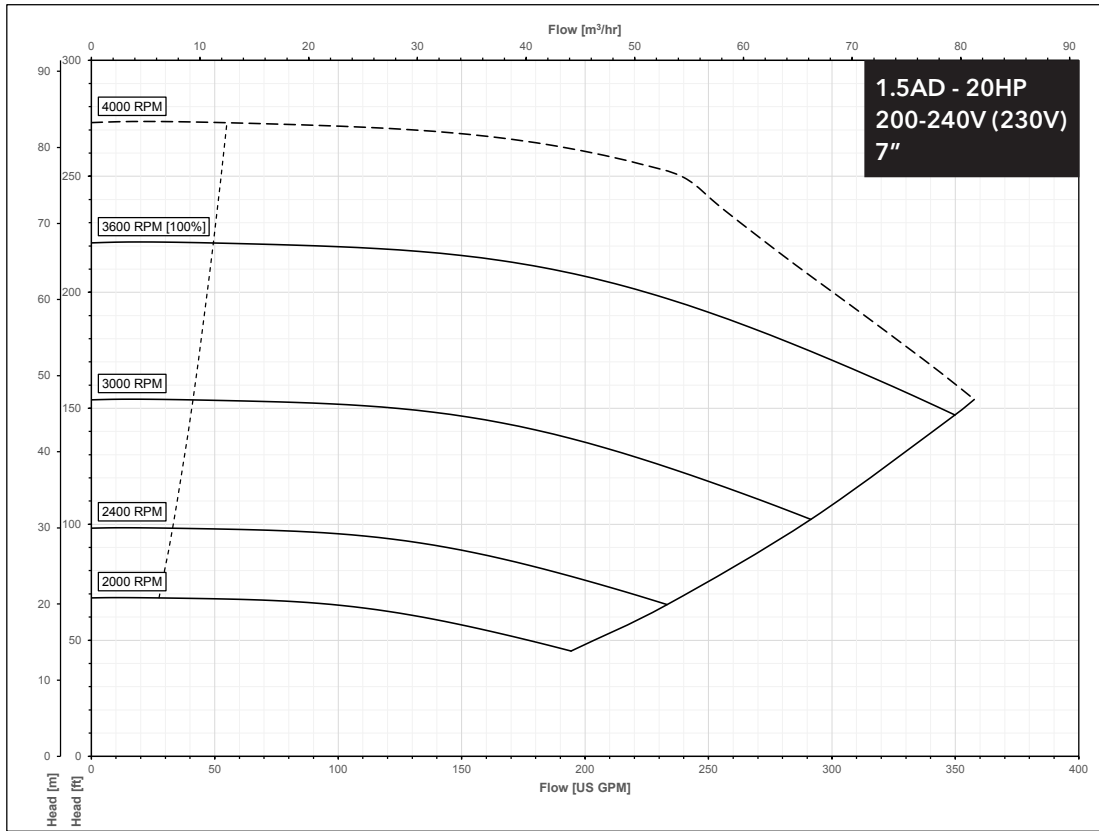

e-1510X PERFORMANCE CURVES FOR HIGH SPEED MODELS

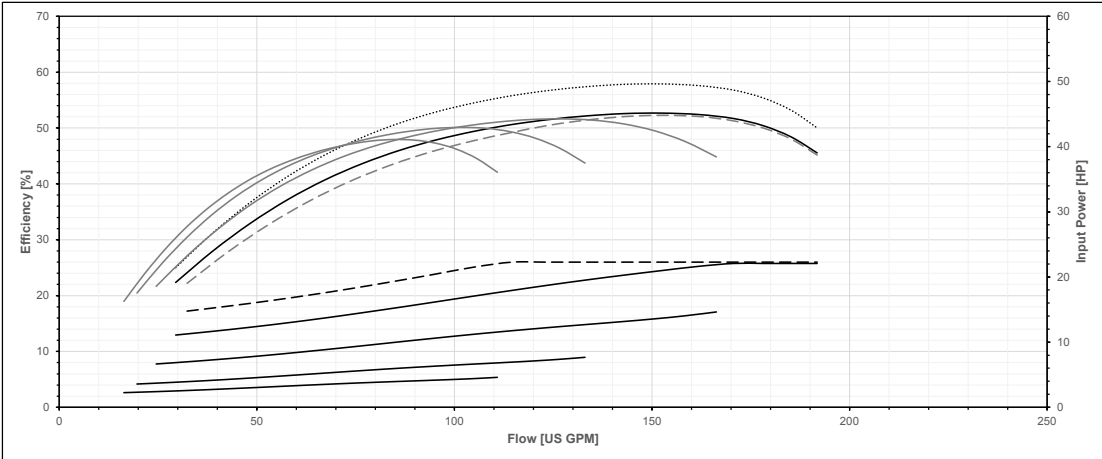
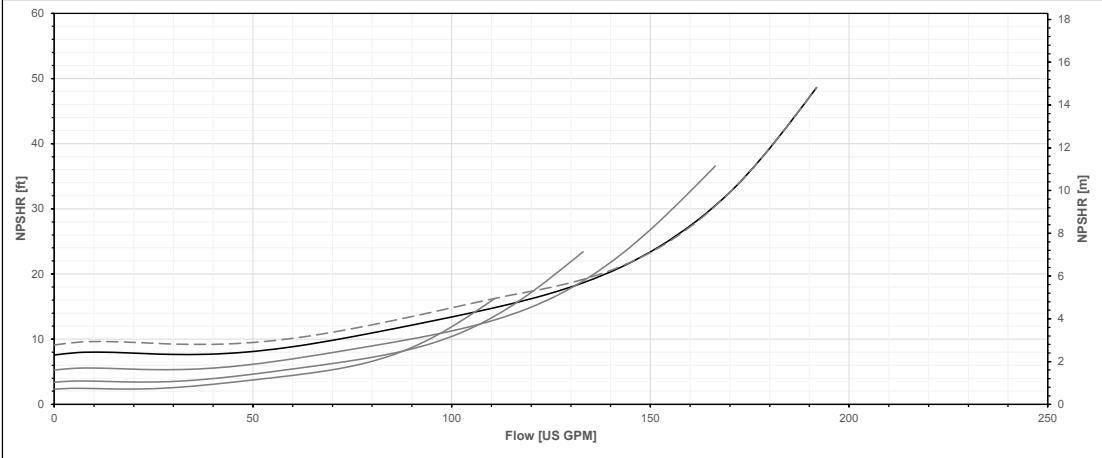
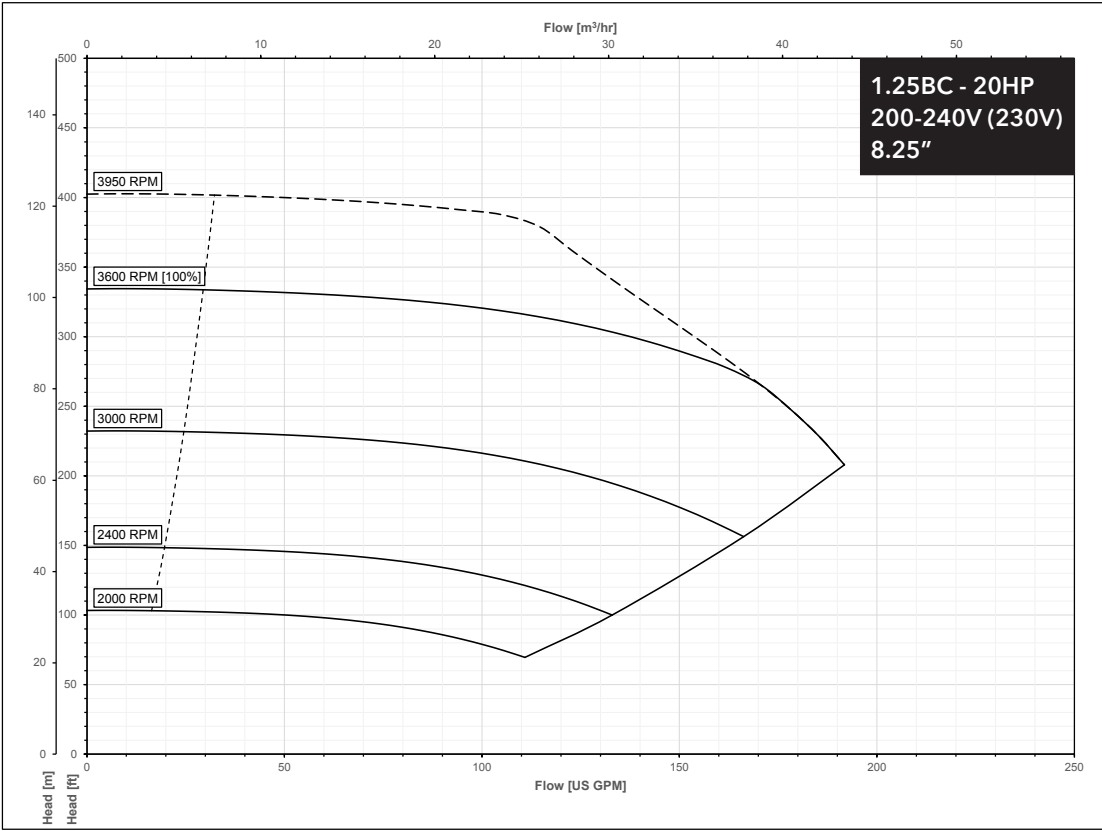

e-1510X PERFORMANCE CURVES FOR HIGH SPEED MODELS

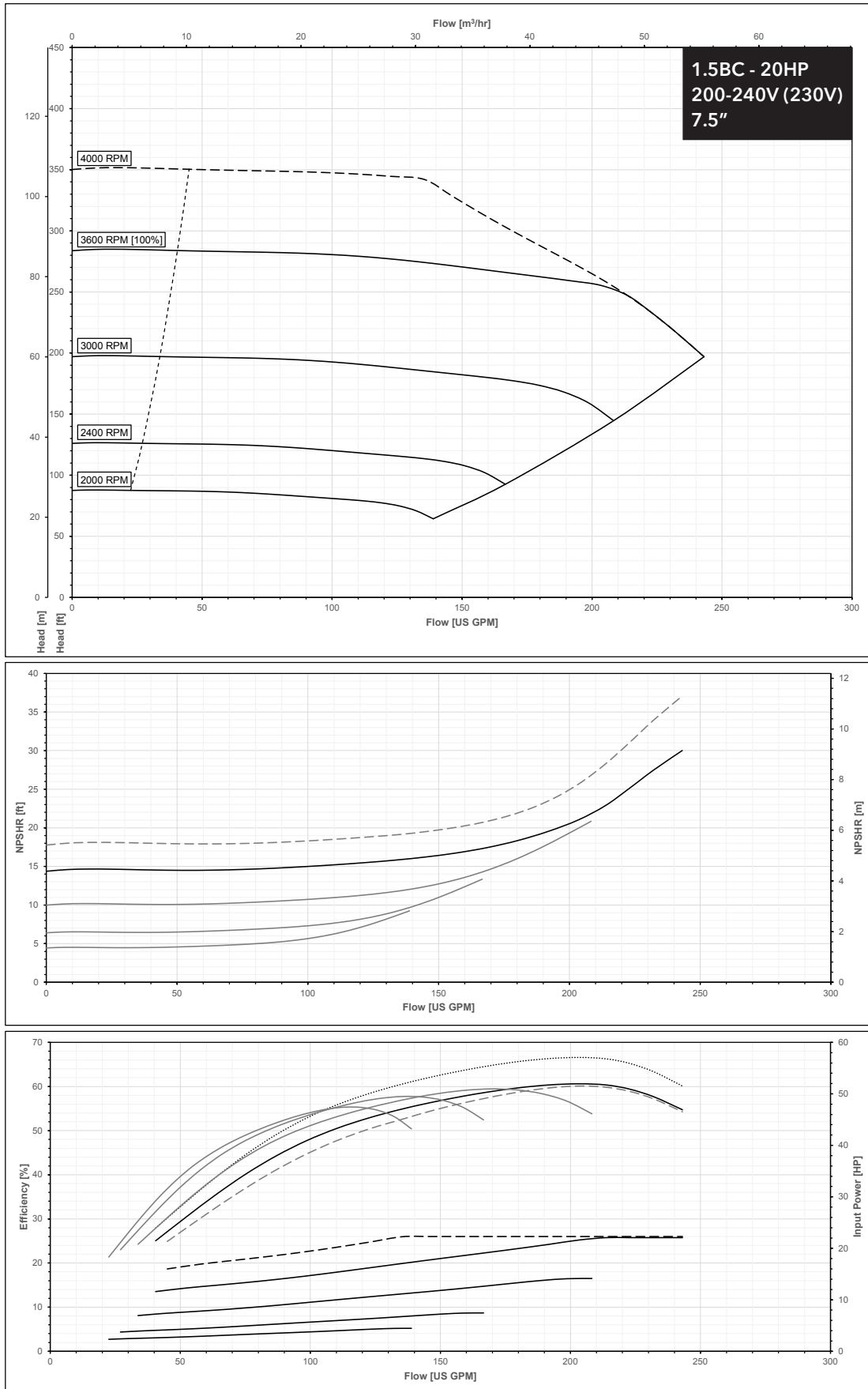

e-1510X PERFORMANCE CURVES FOR HIGH SPEED MODELS

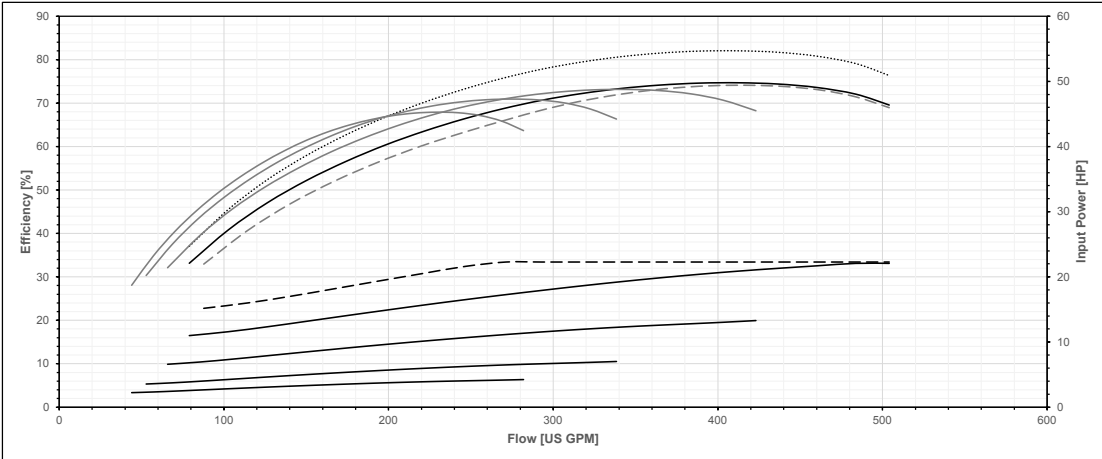
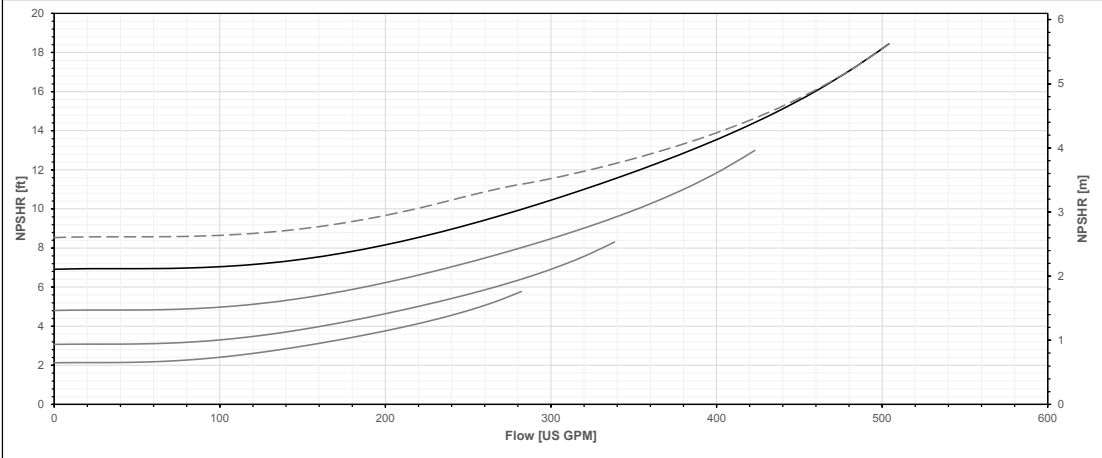
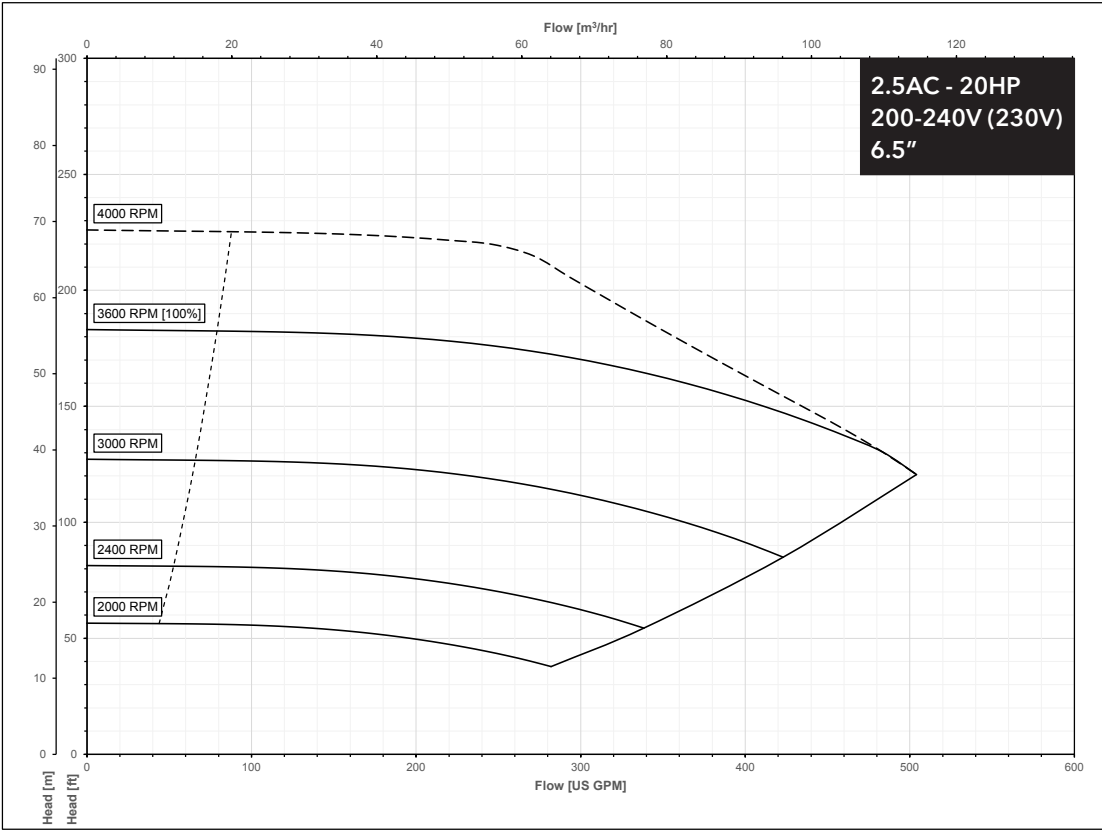

e-1510X PERFORMANCE CURVES FOR HIGH SPEED MODELS

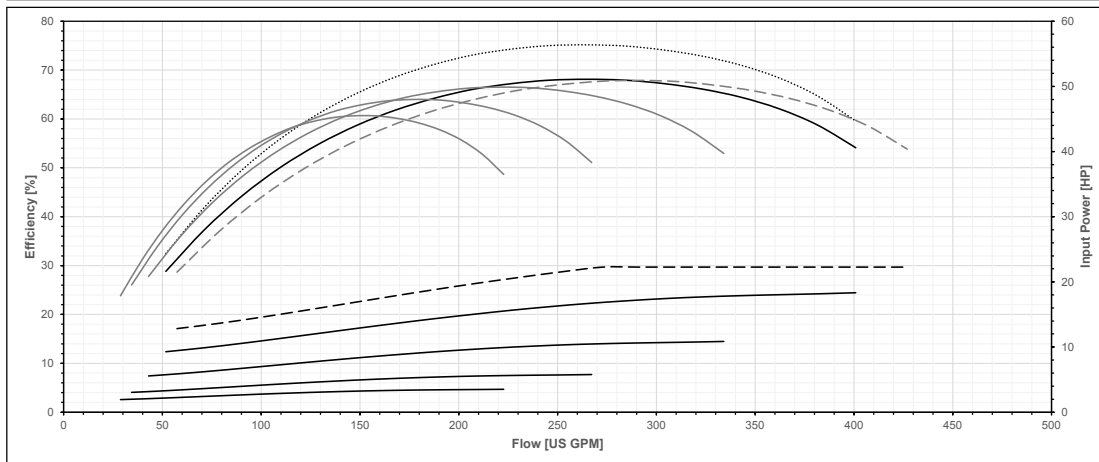
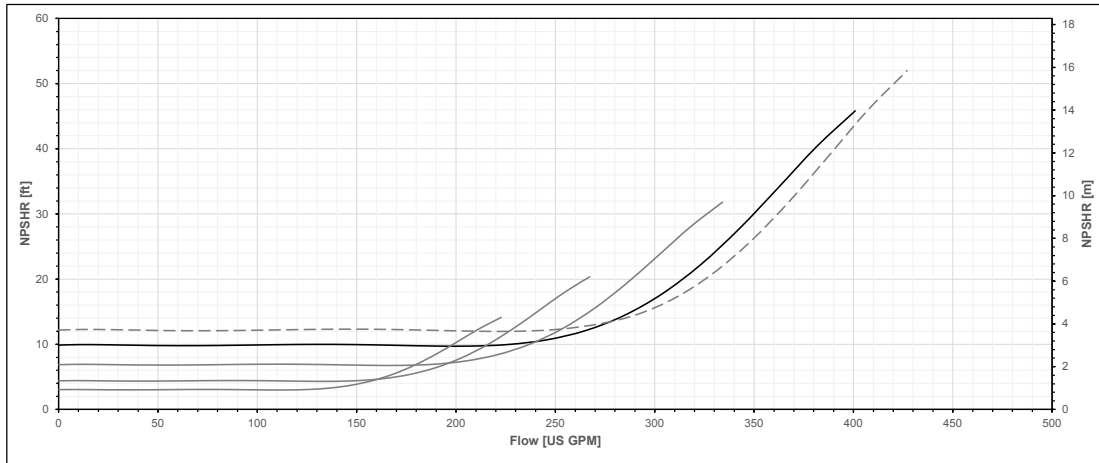
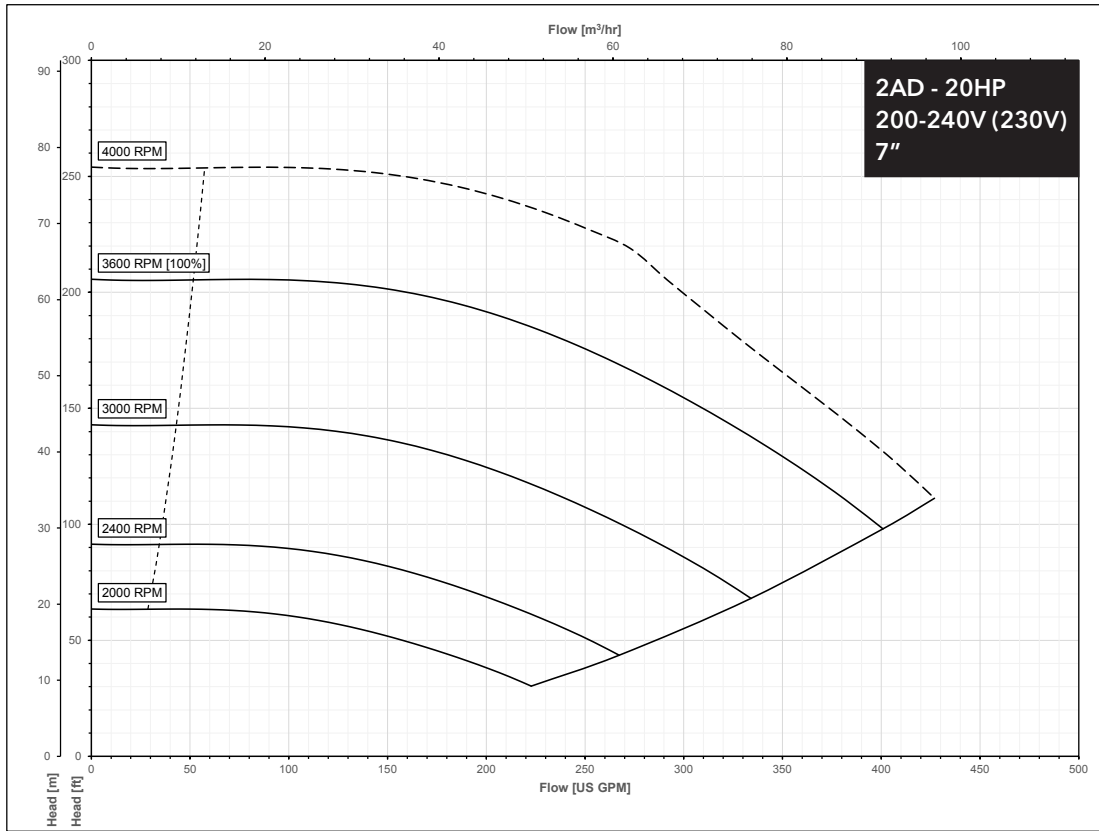

e-1510X PERFORMANCE CURVES FOR HIGH SPEED MODELS

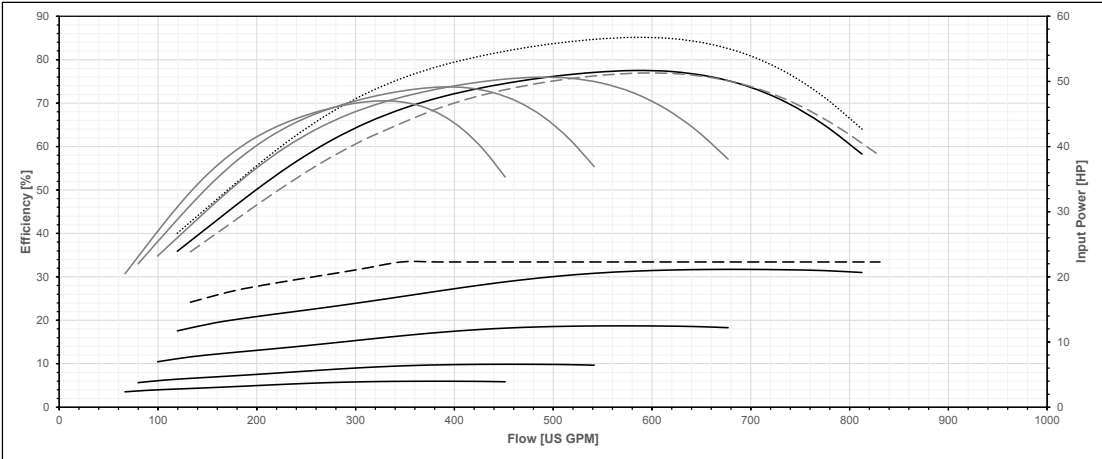
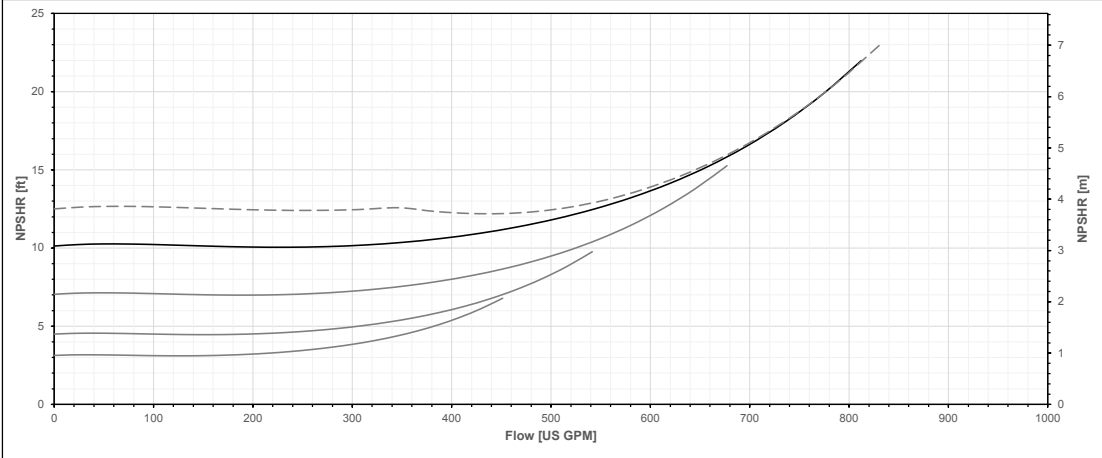
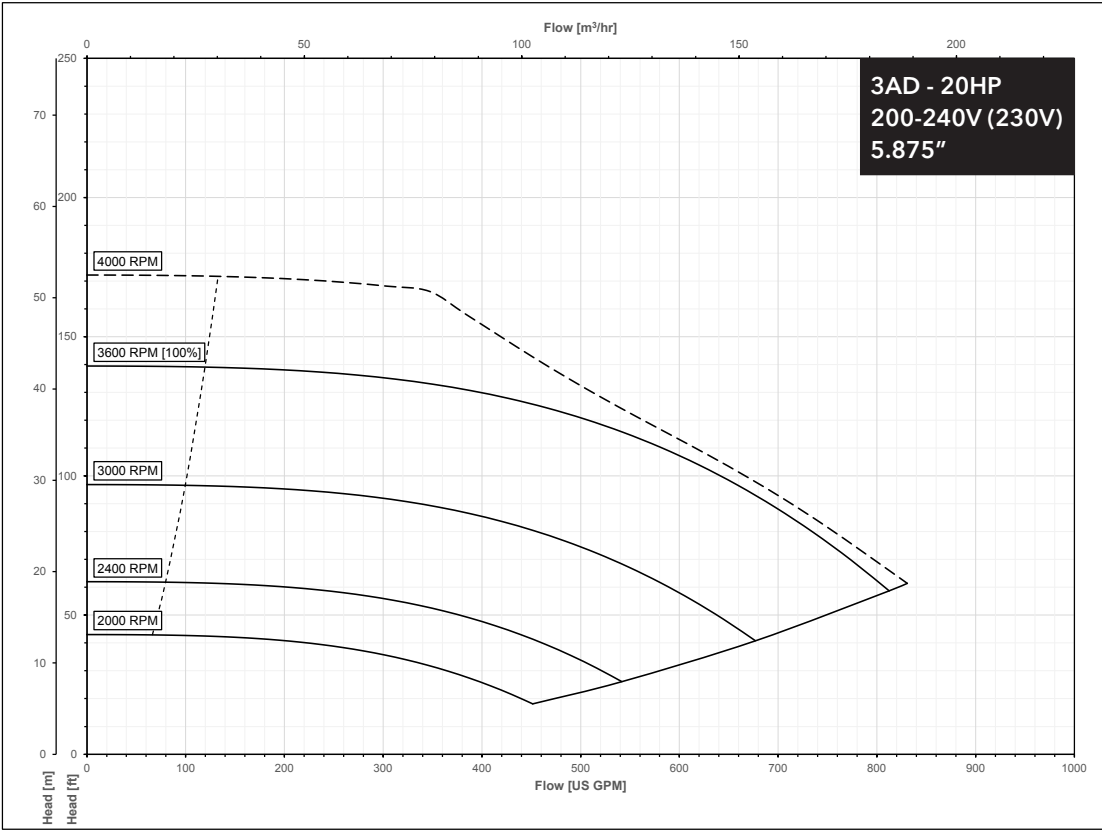

e-1510X PERFORMANCE CURVES FOR HIGH SPEED MODELS

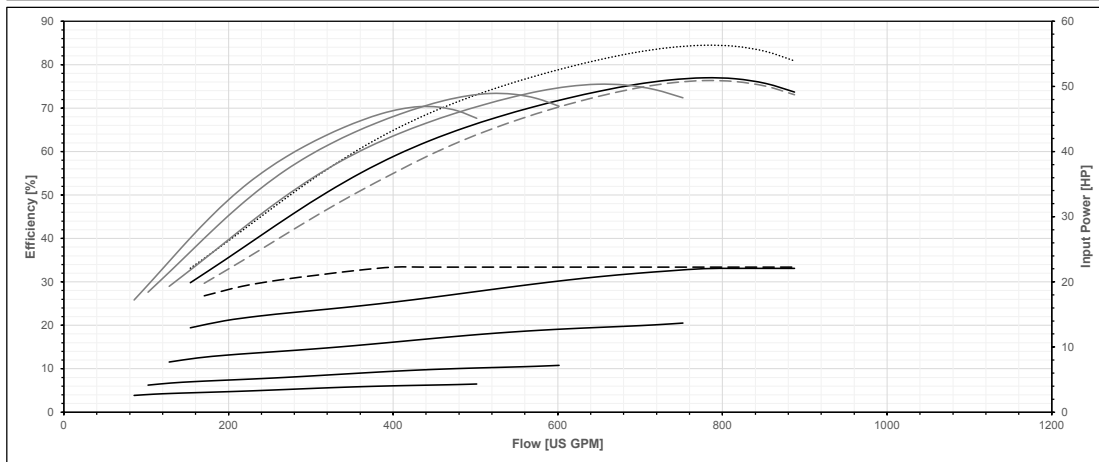
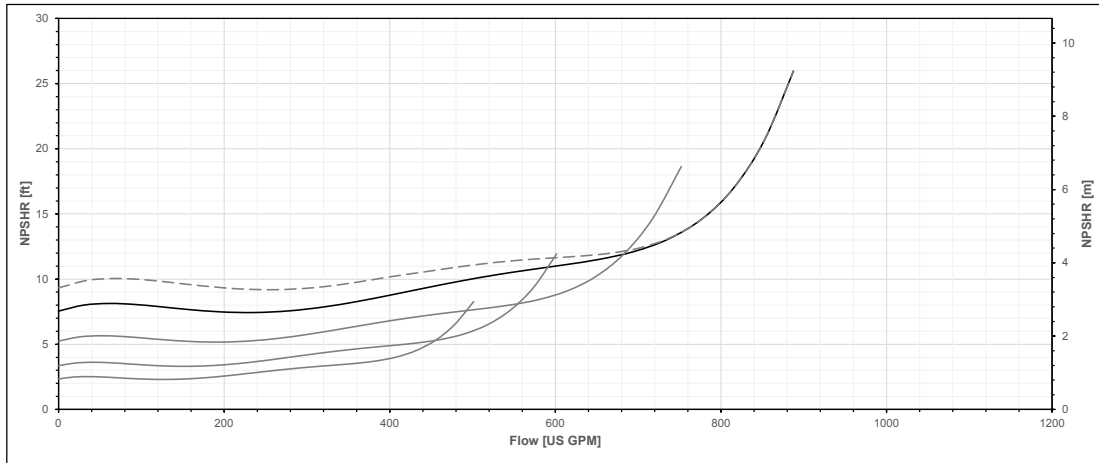
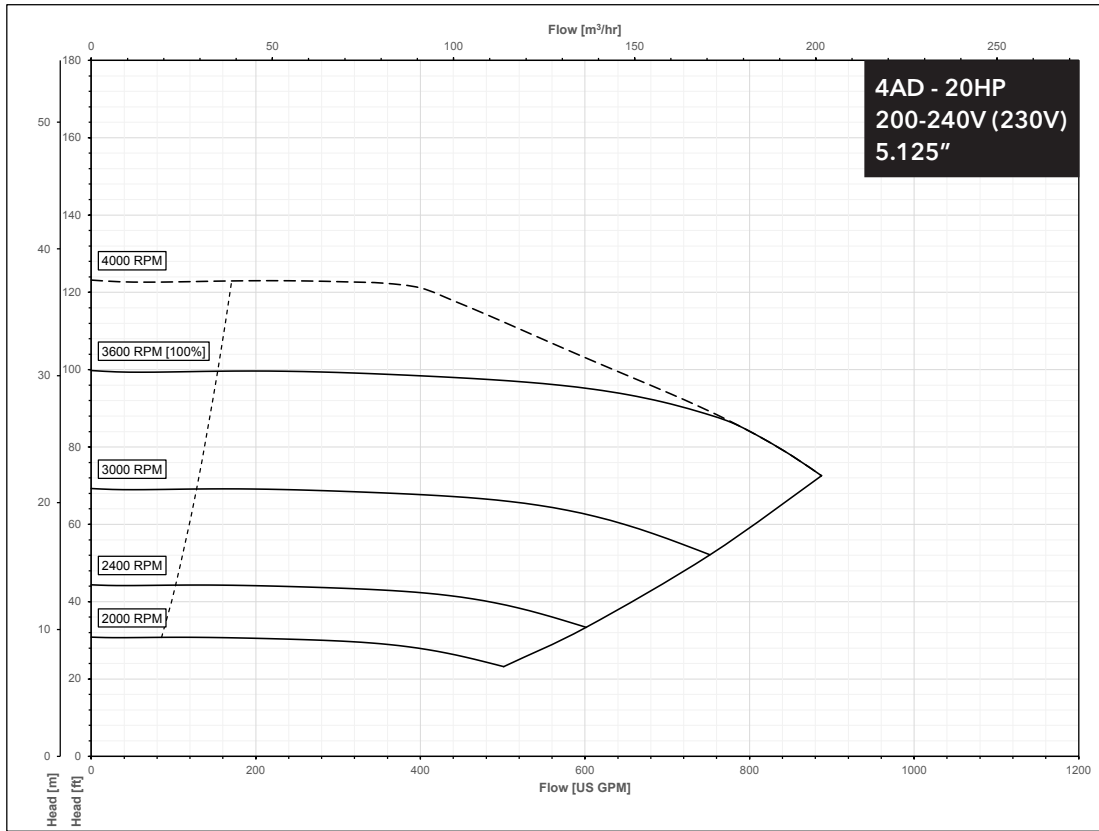

e-1510X PERFORMANCE CURVES FOR LOW SPEED MODELS

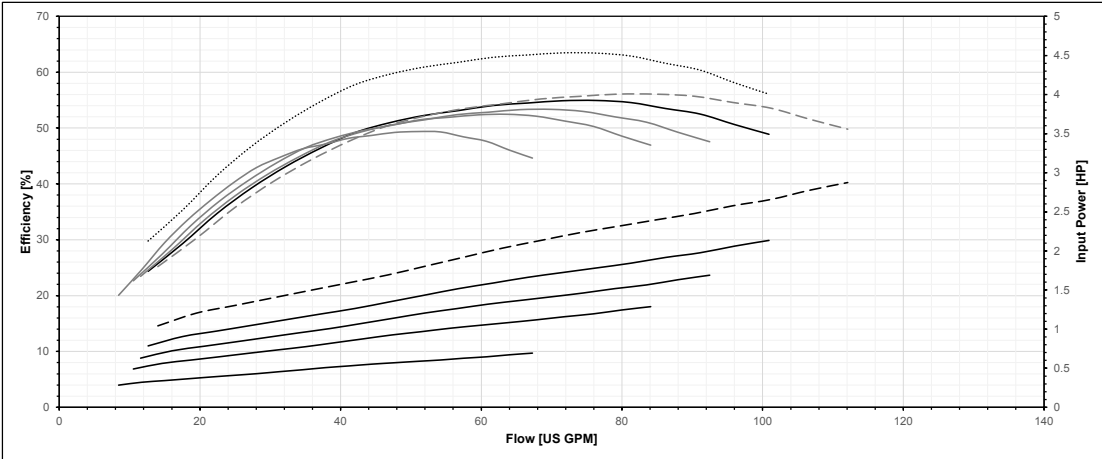
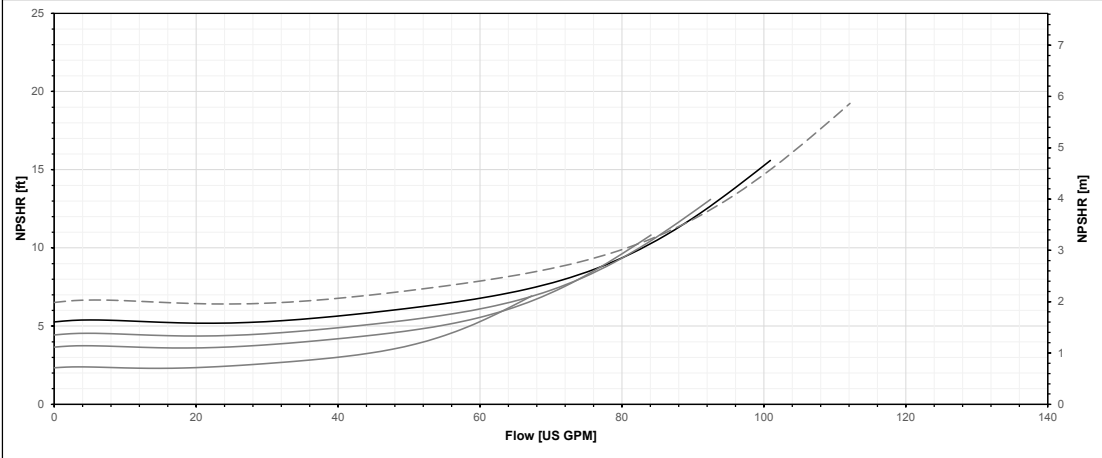
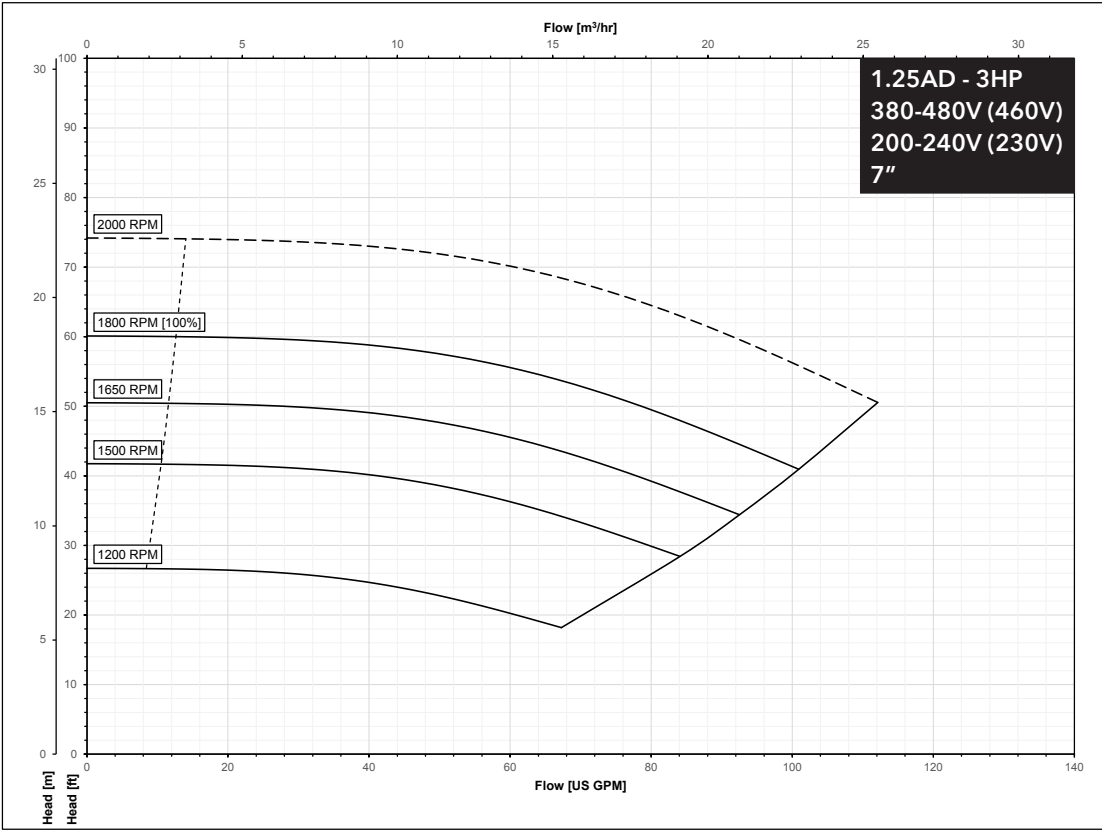

e-1510X PERFORMANCE CURVES FOR LOW SPEED MODELS

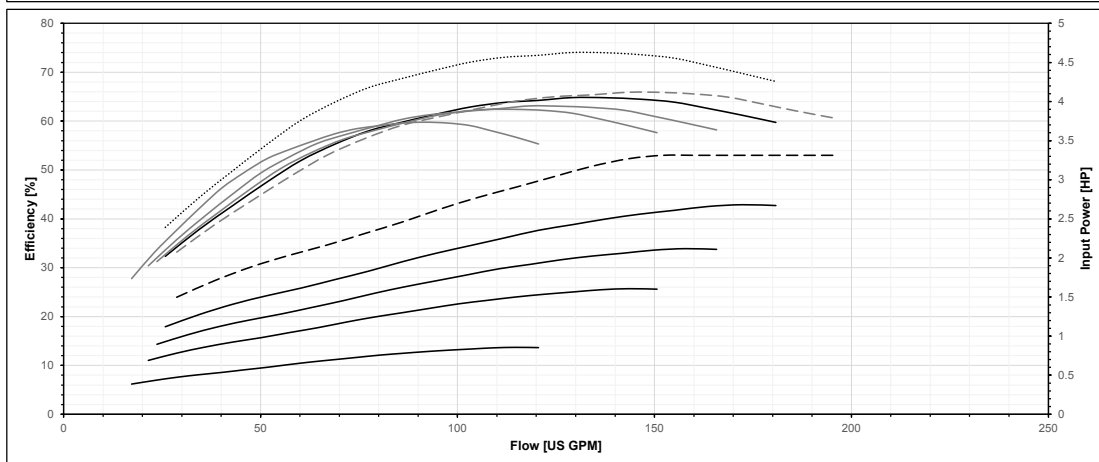
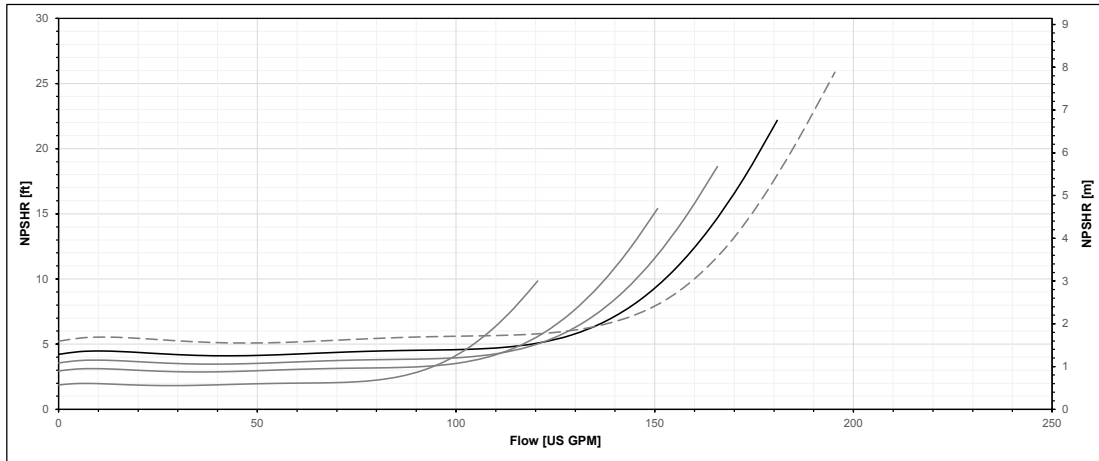
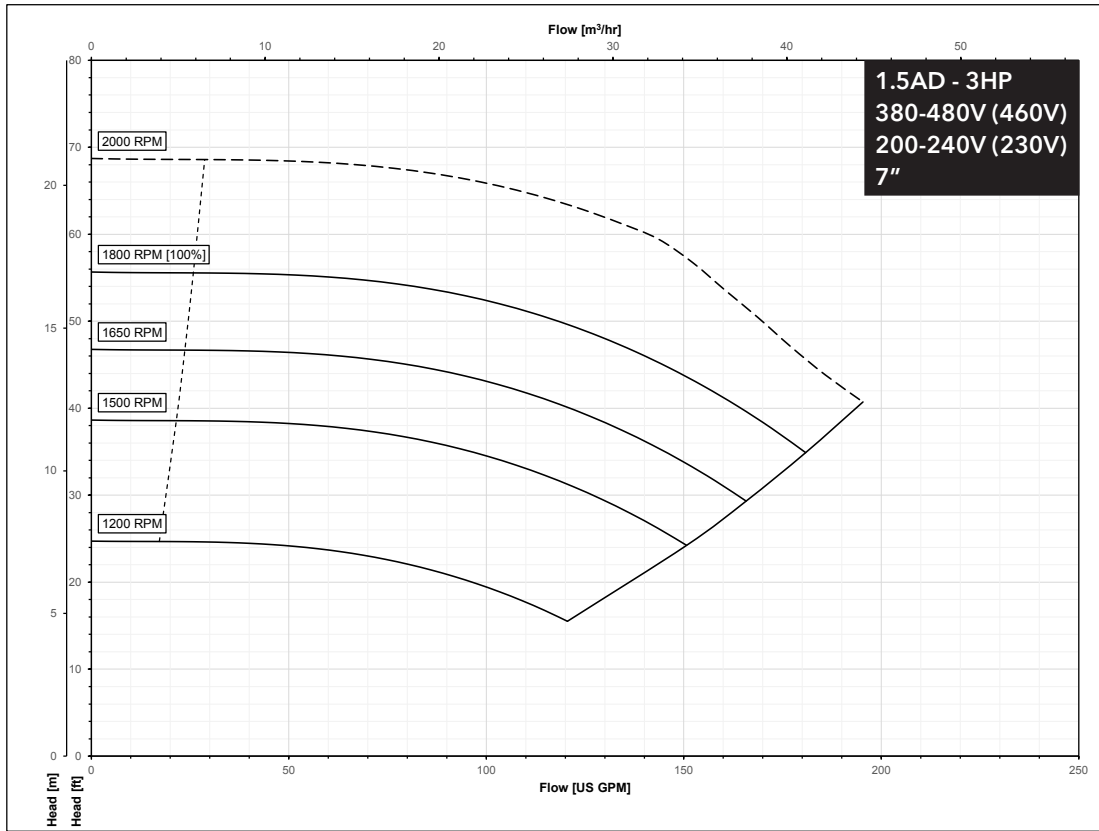

e-1510X PERFORMANCE CURVES FOR LOW SPEED MODELS

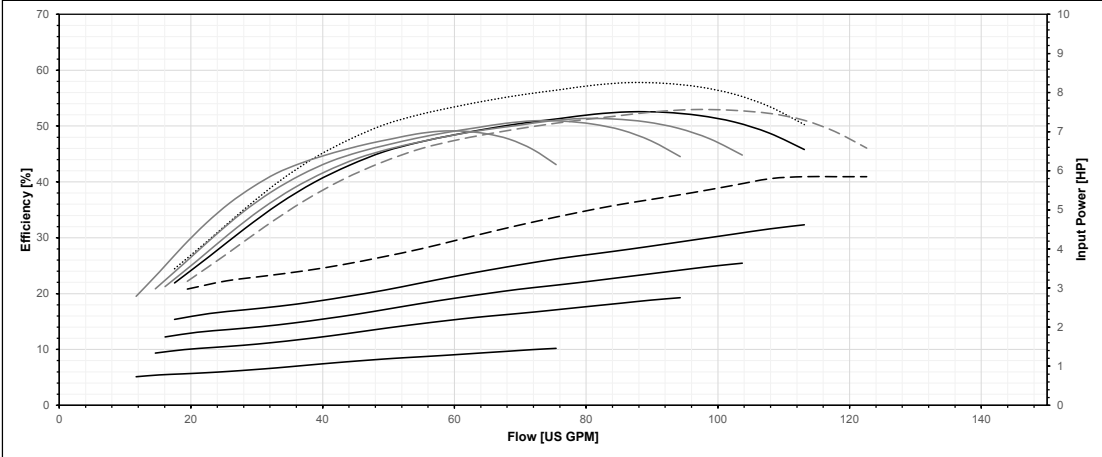
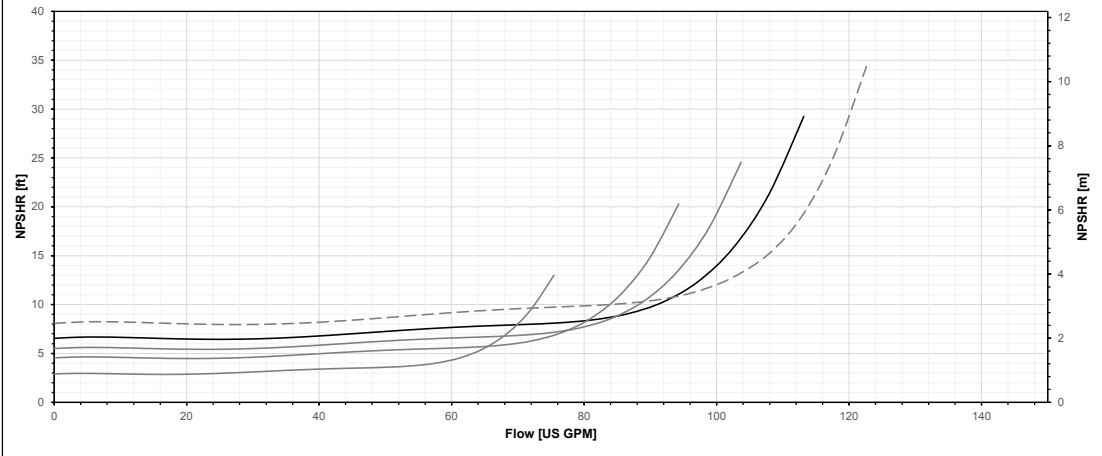
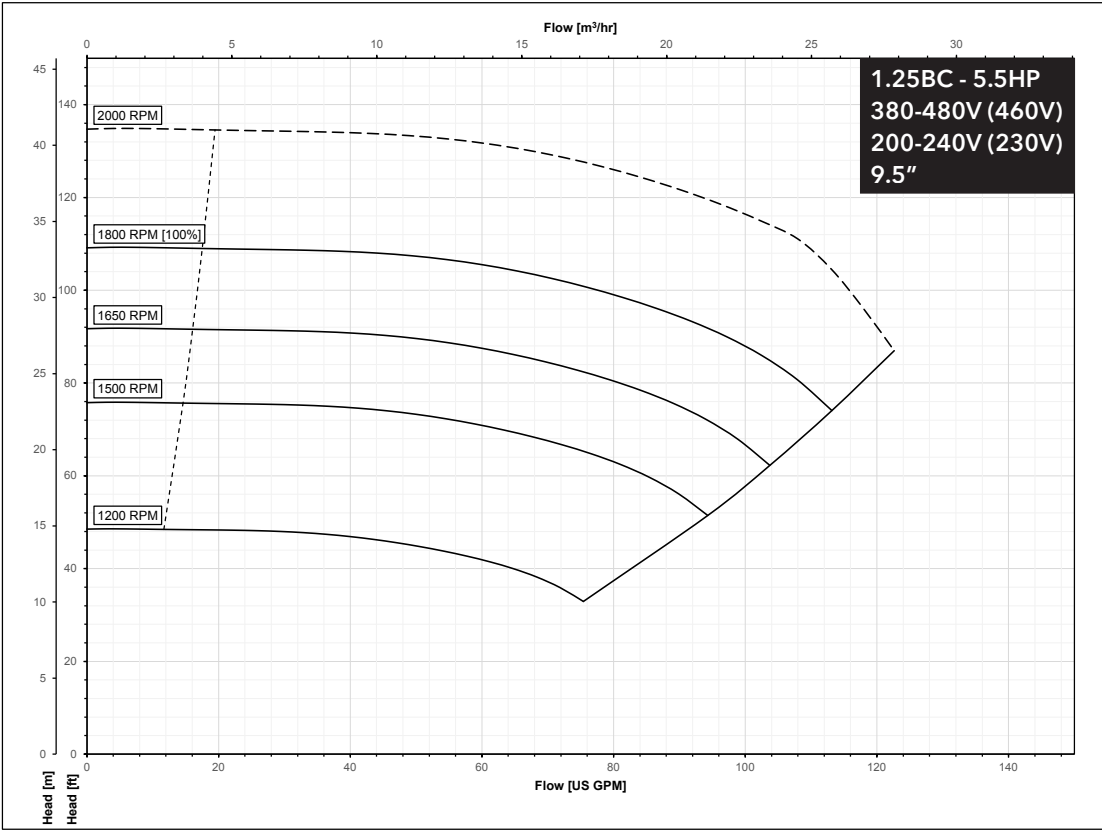

e-1510X PERFORMANCE CURVES FOR LOW SPEED MODELS

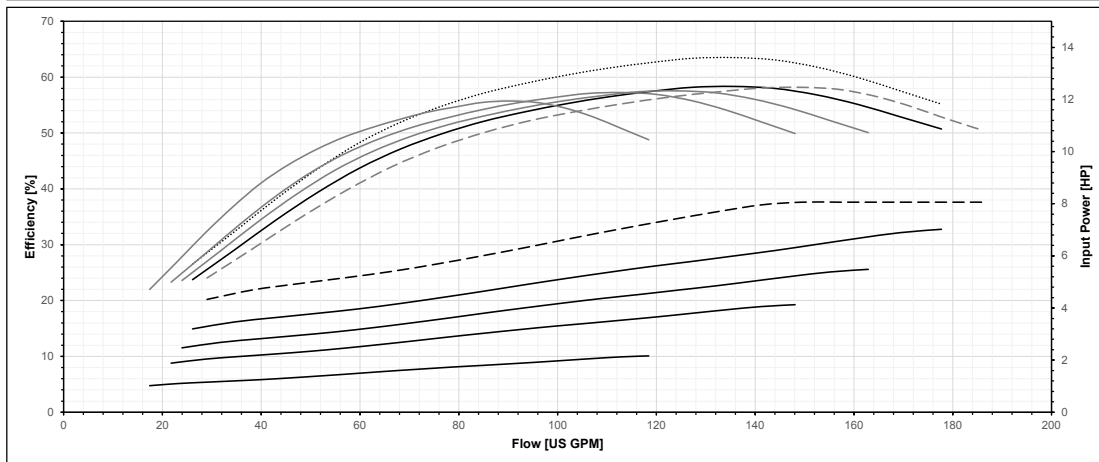
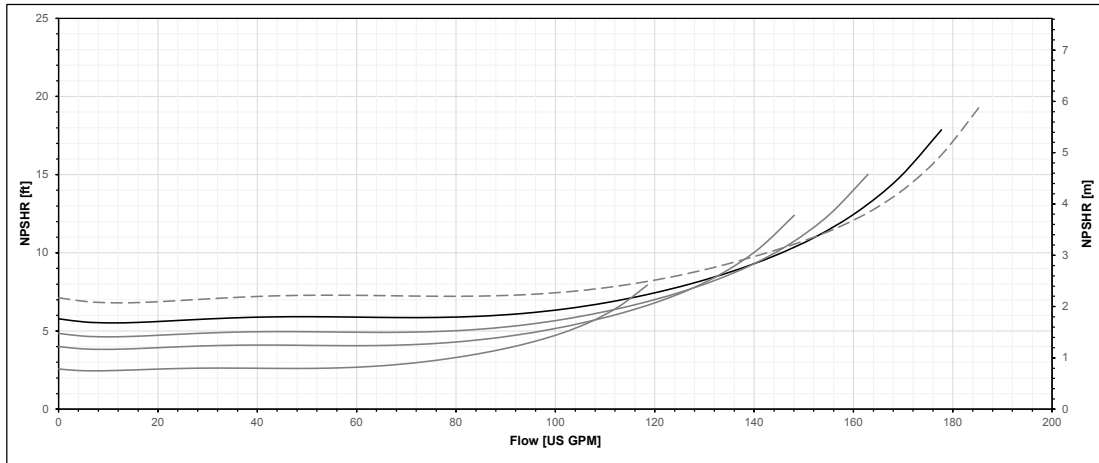
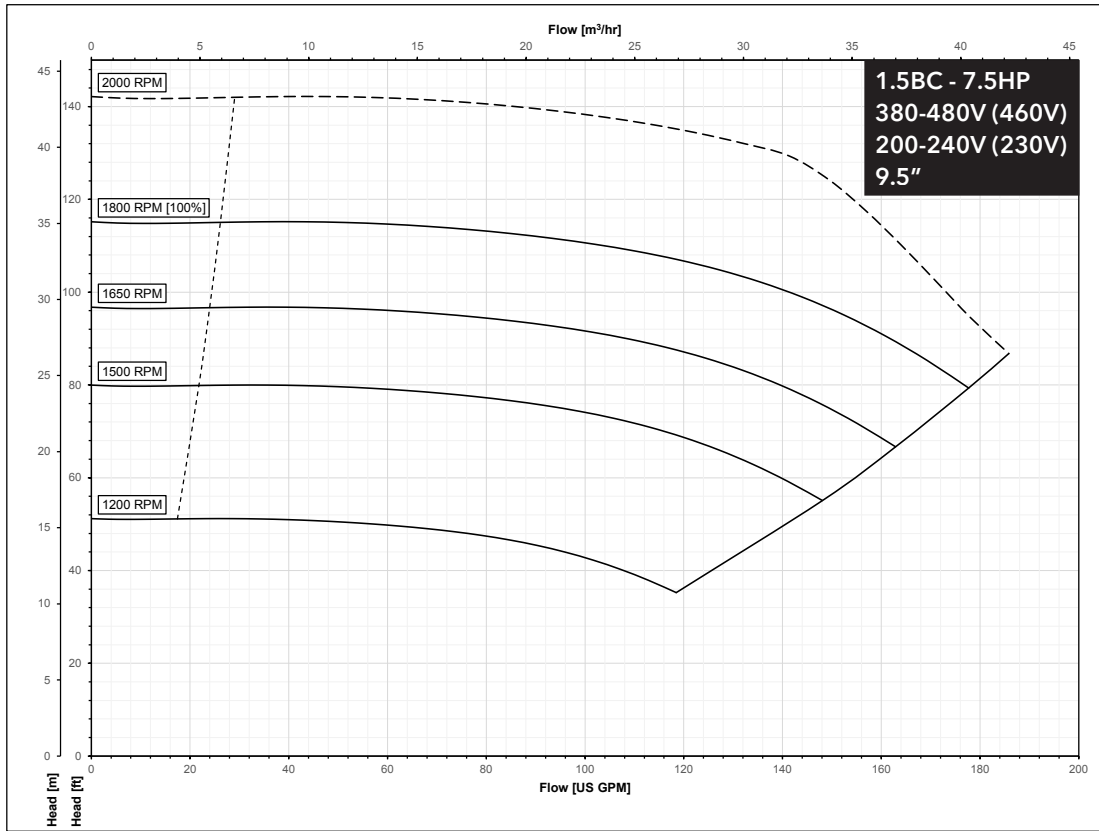

e-1510X PERFORMANCE CURVES FOR LOW SPEED MODELS

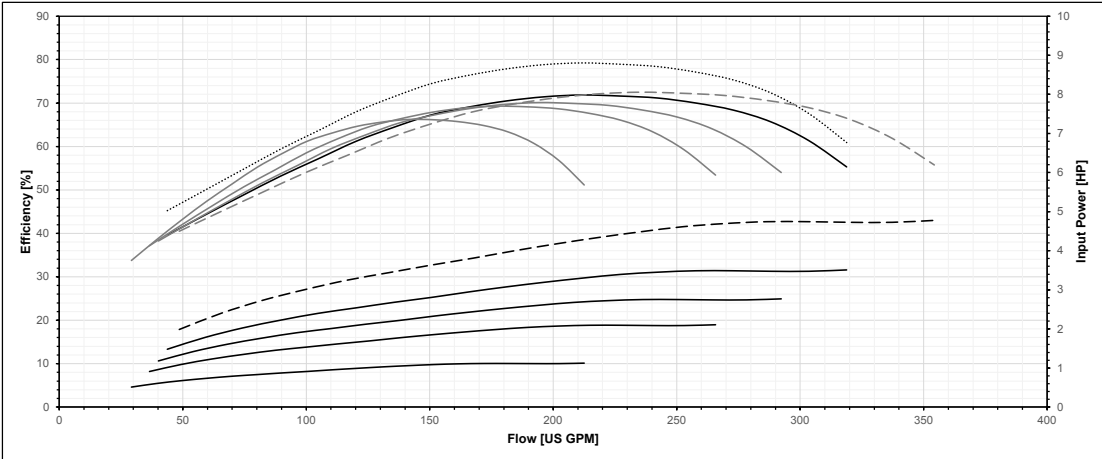
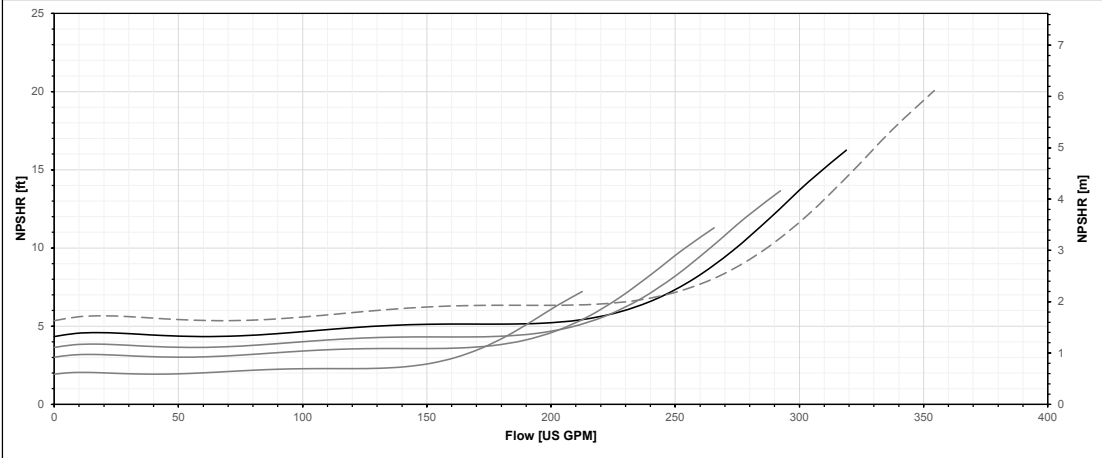
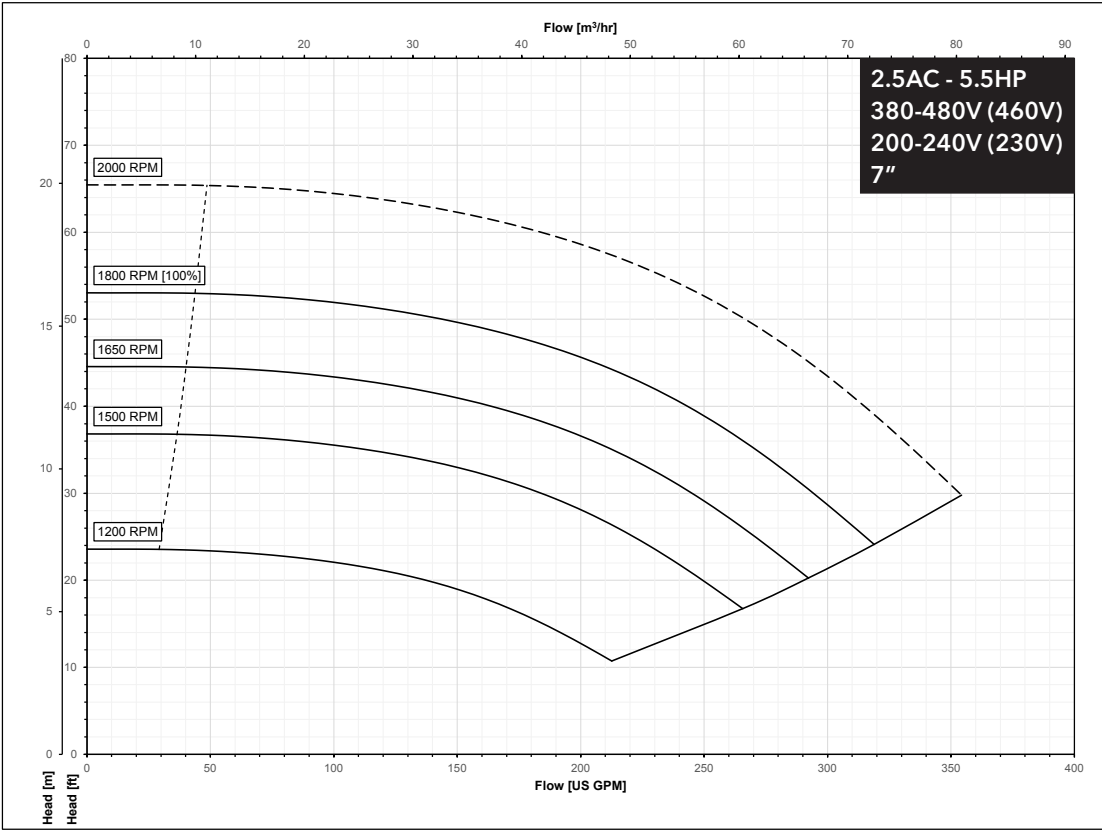

e-1510X PERFORMANCE CURVES FOR LOW SPEED MODELS

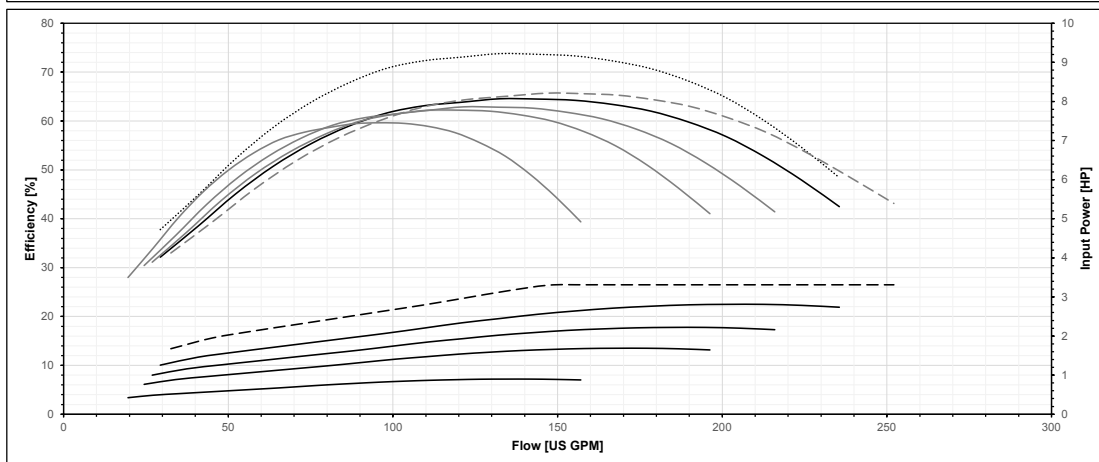
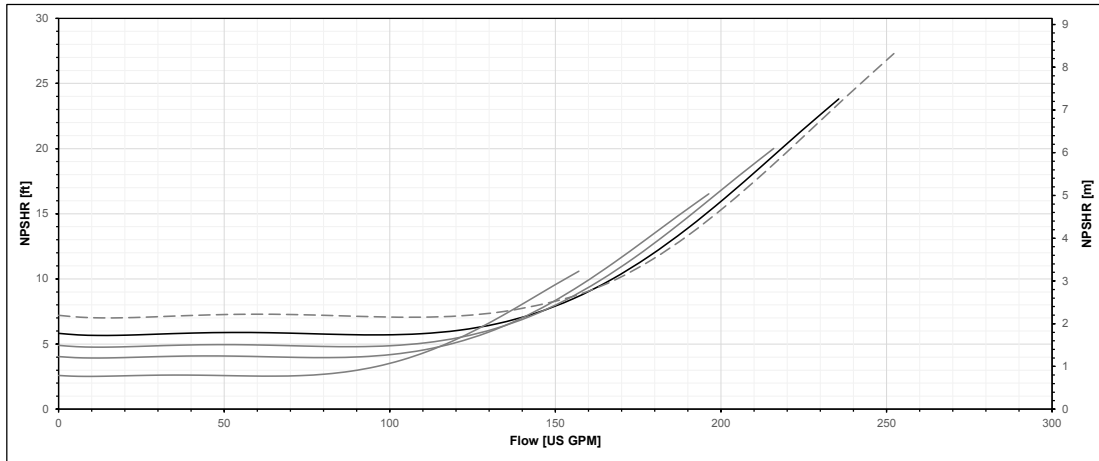
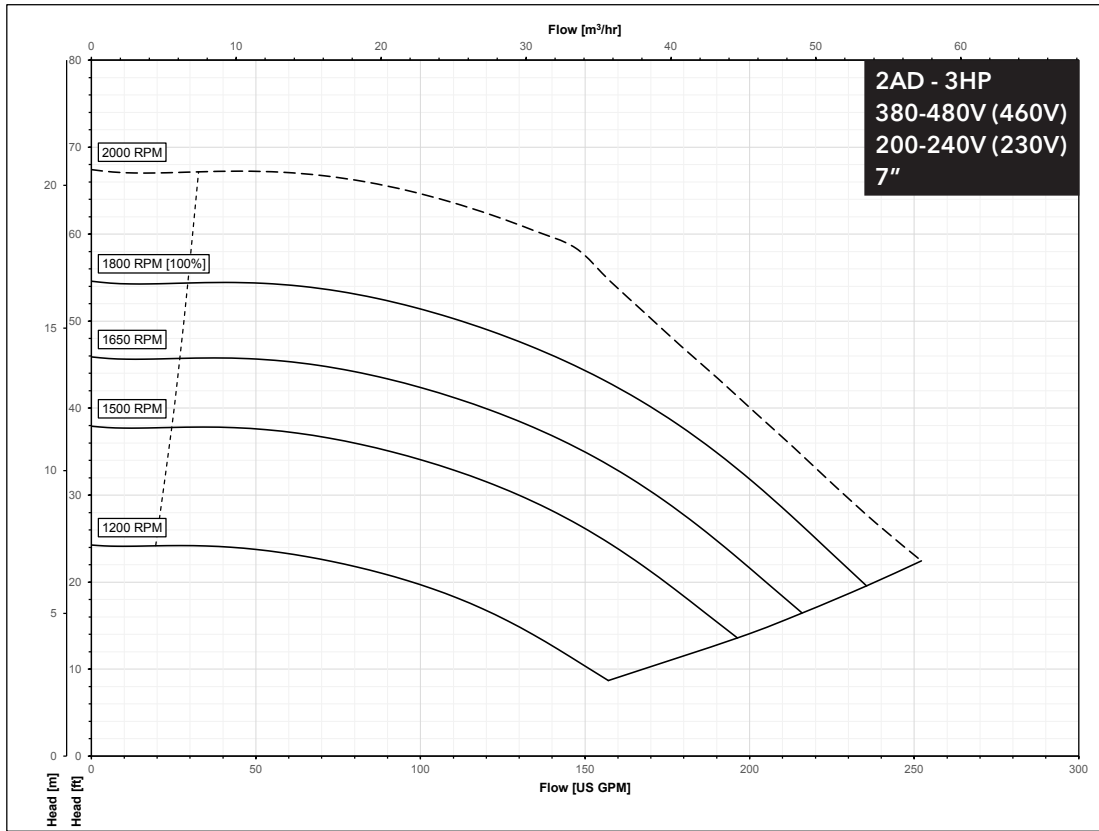

e-1510X PERFORMANCE CURVES FOR LOW SPEED MODELS

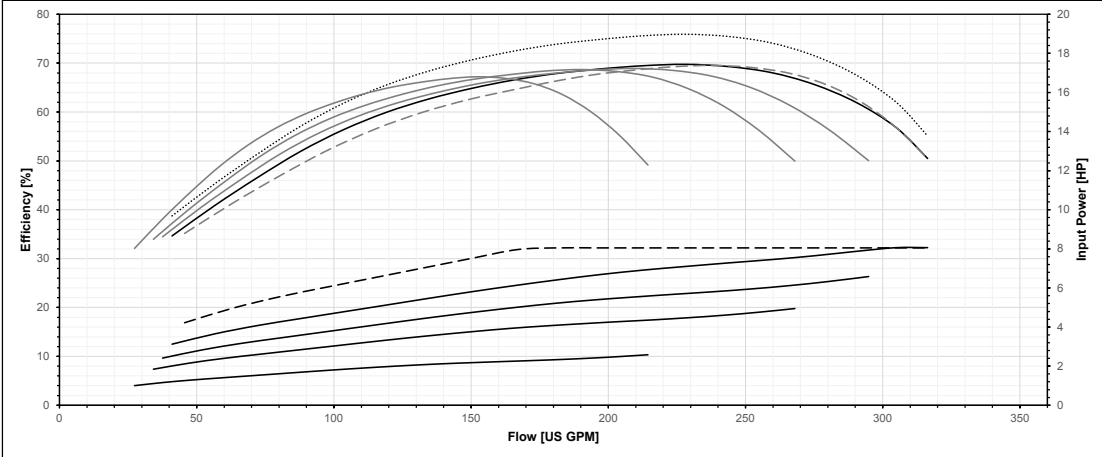
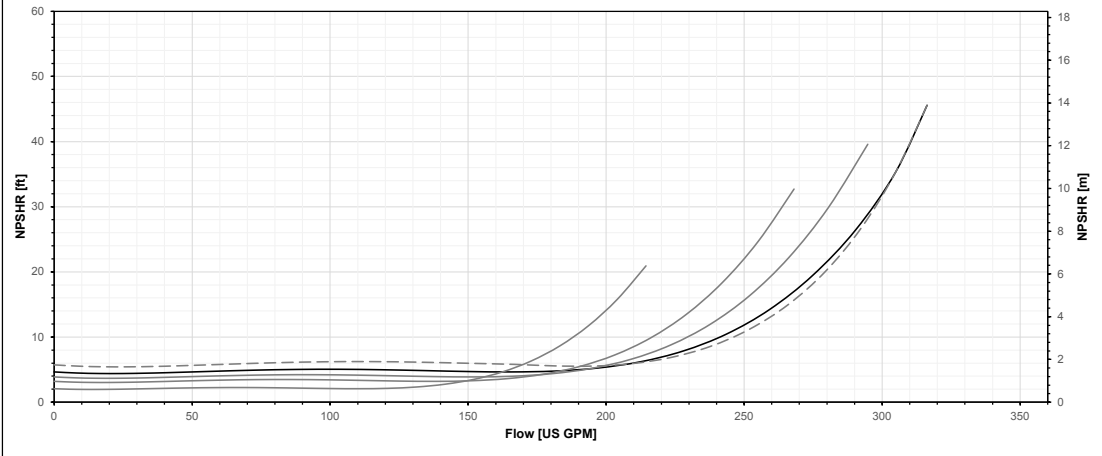
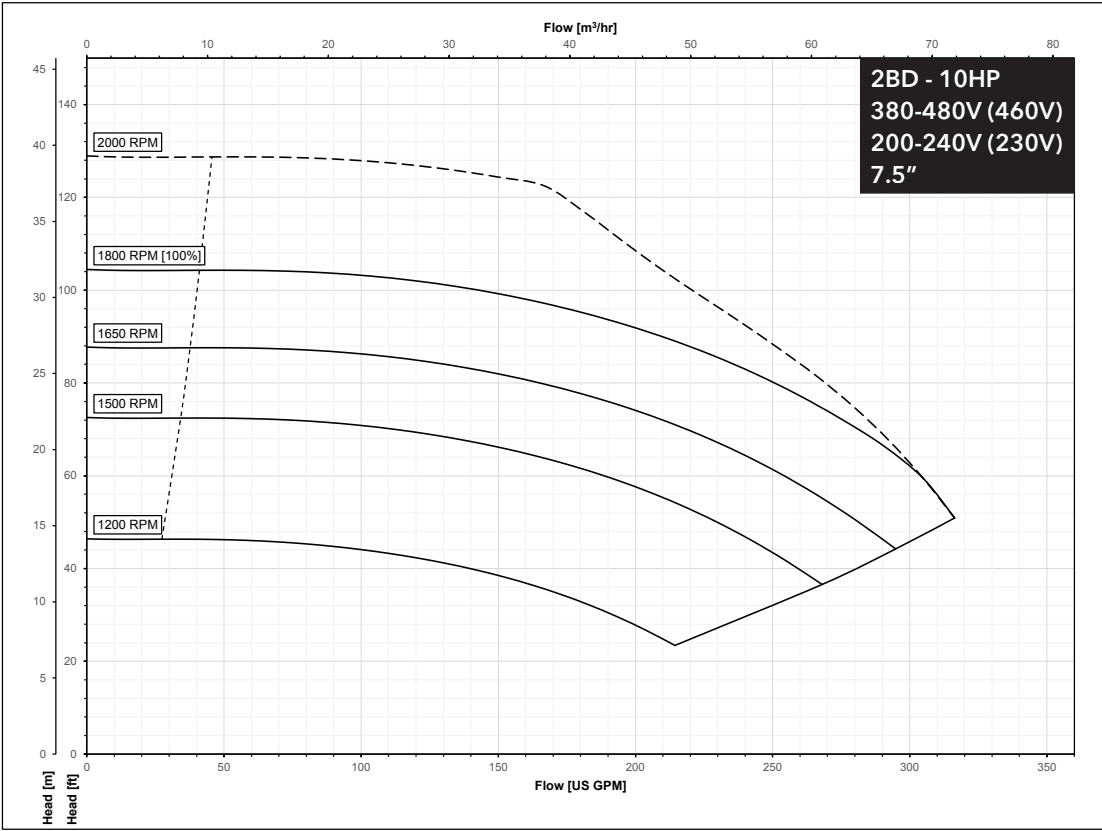

e-1510X PERFORMANCE CURVES FOR LOW SPEED MODELS

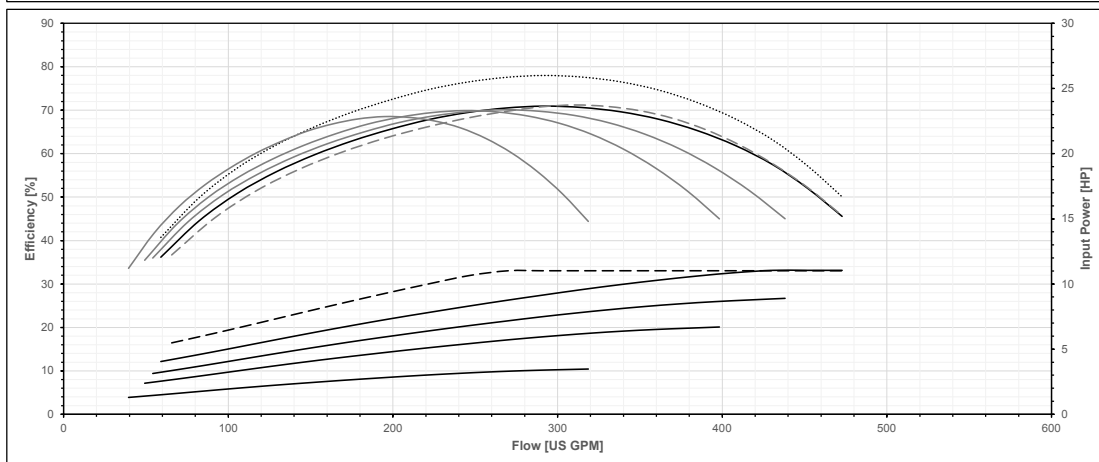
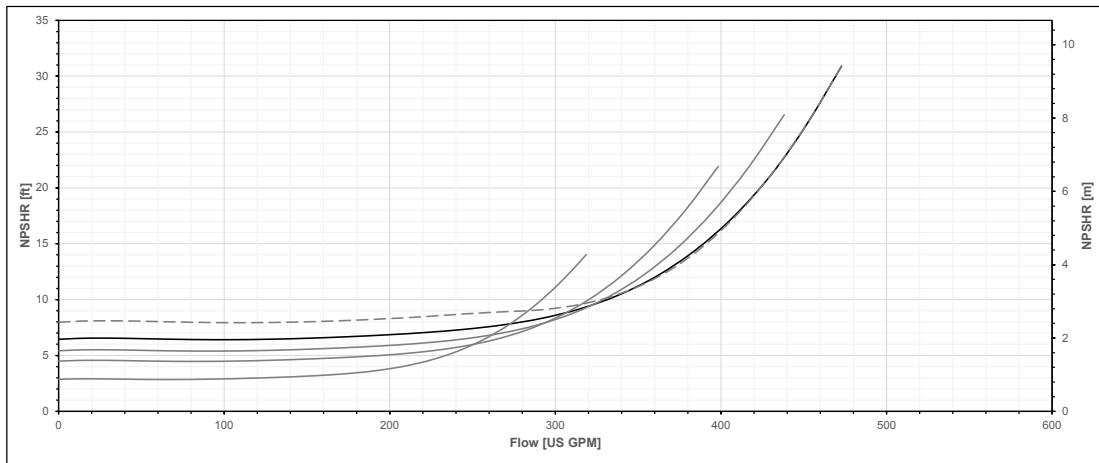
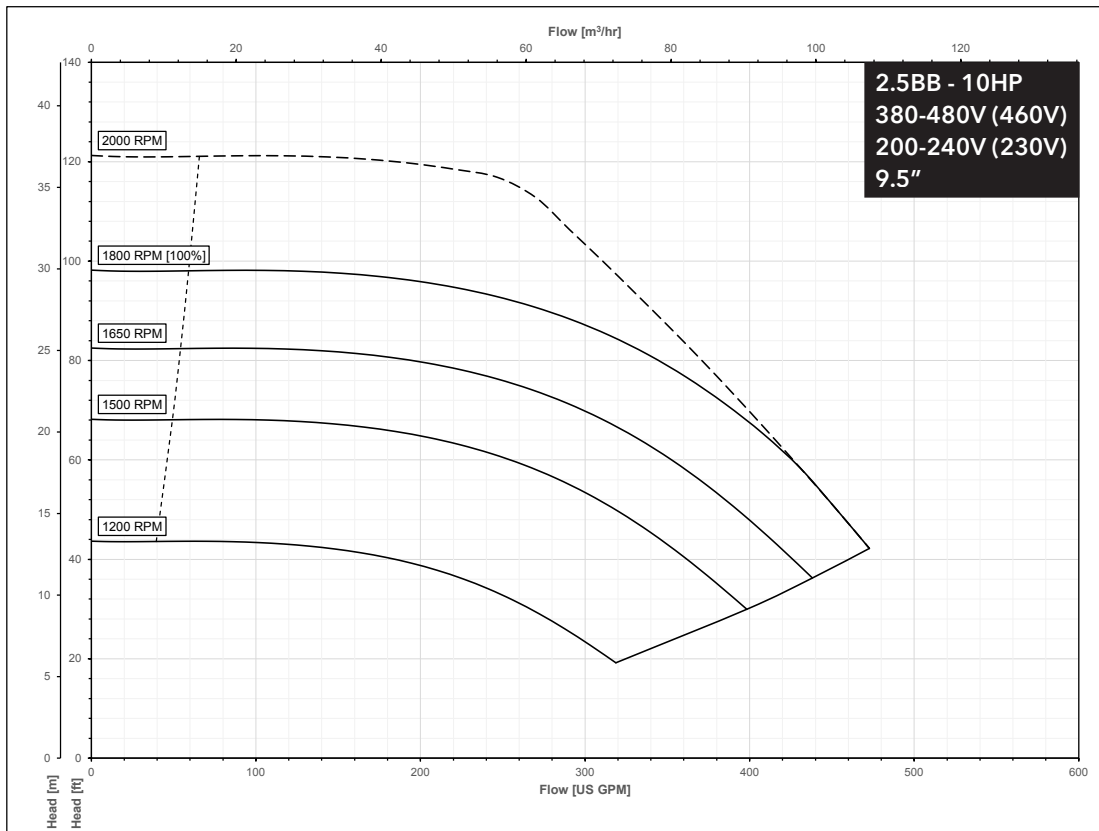

e-1510X PERFORMANCE CURVES FOR LOW SPEED MODELS

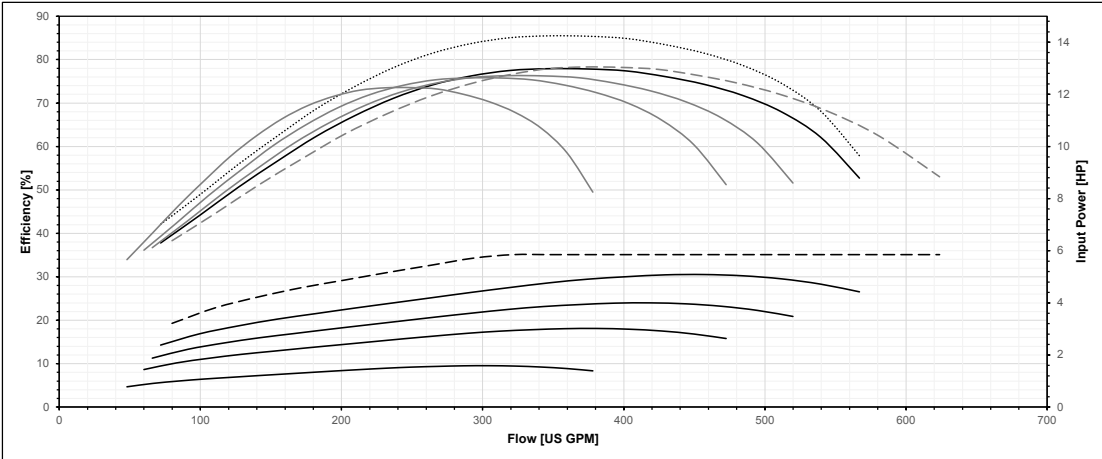
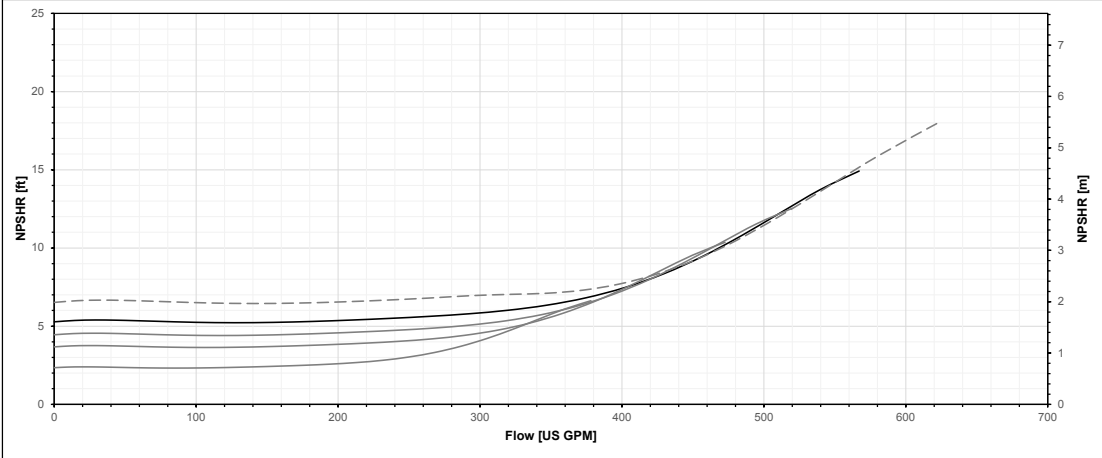
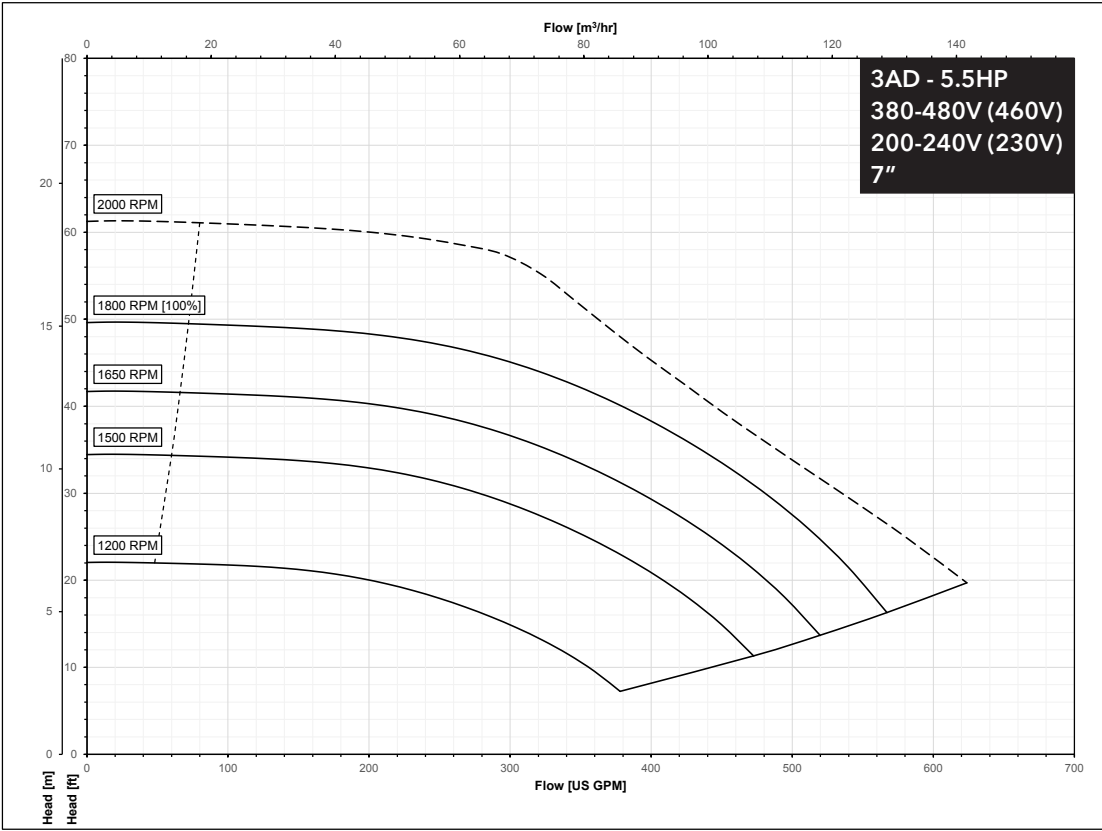

e-1510X PERFORMANCE CURVES FOR LOW SPEED MODELS

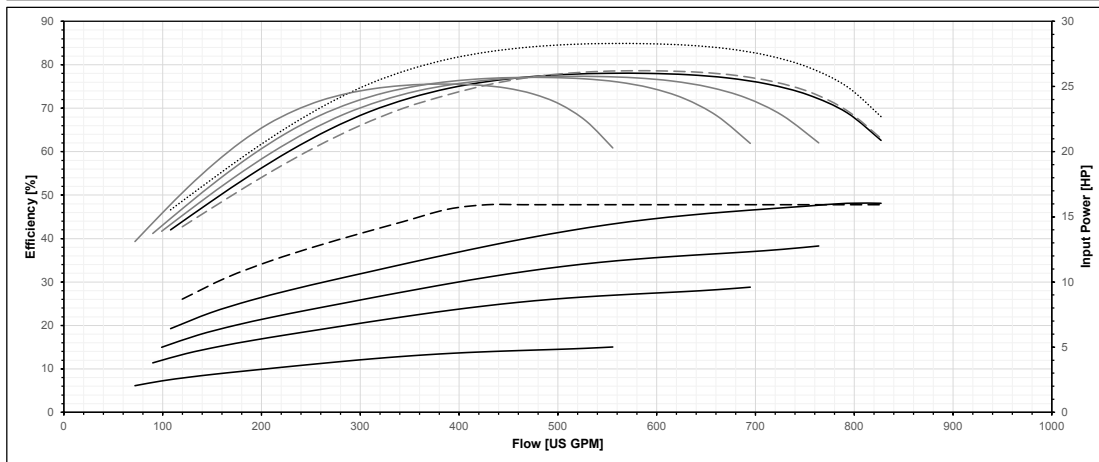
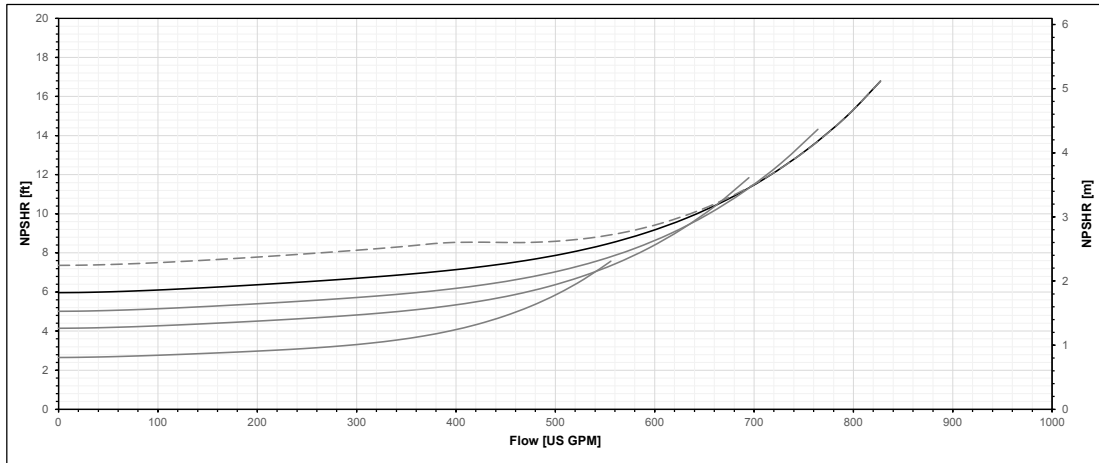
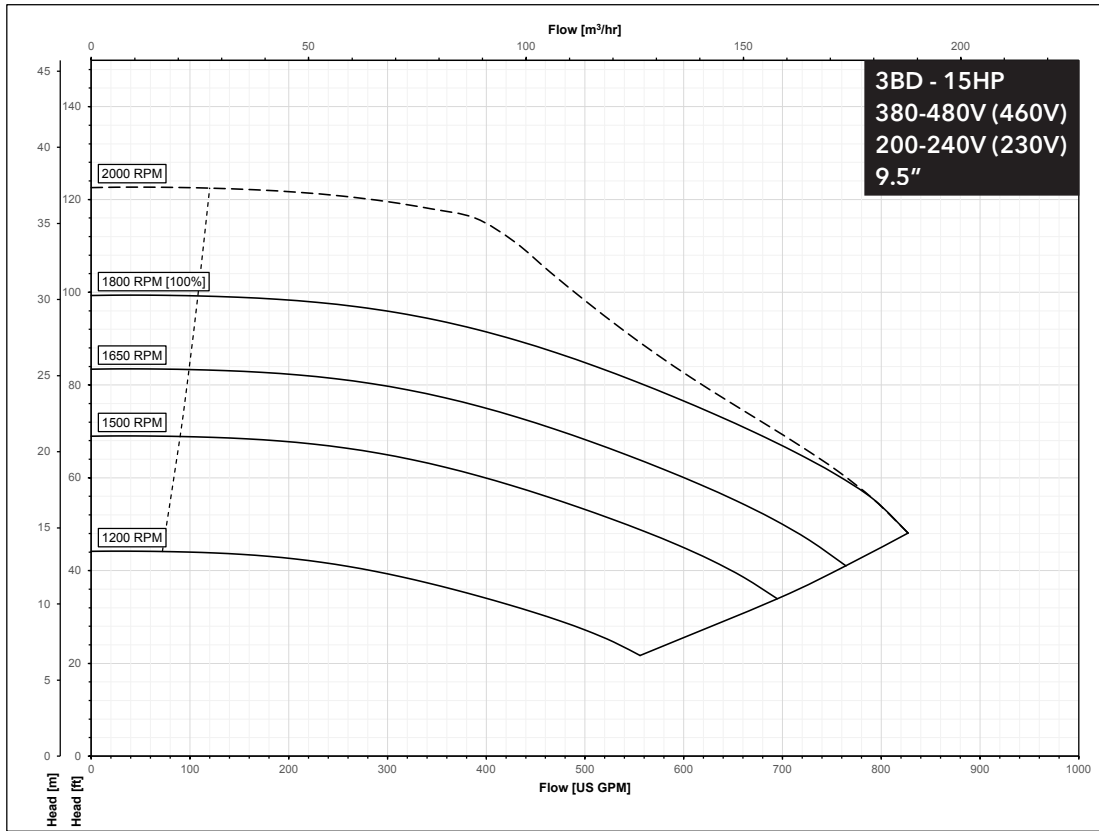

e-1510X PERFORMANCE CURVES FOR LOW SPEED MODELS

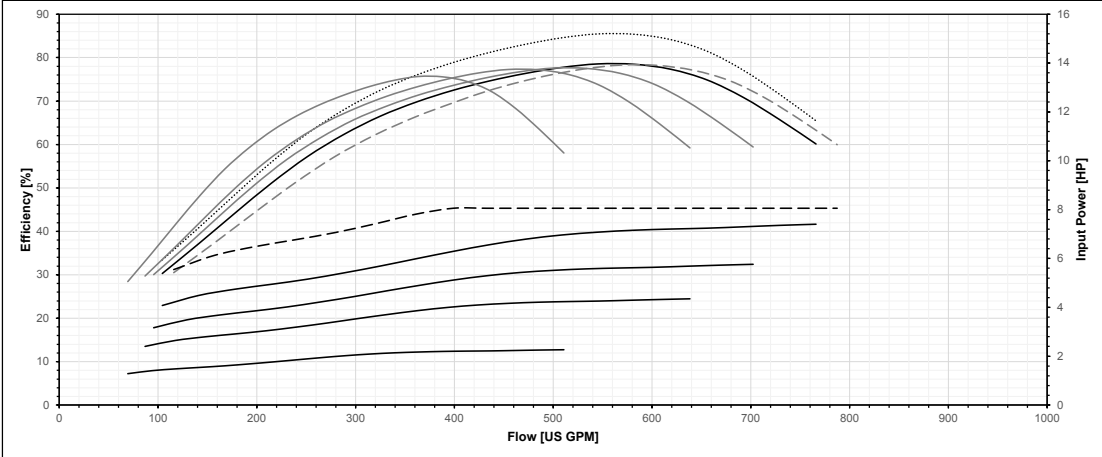
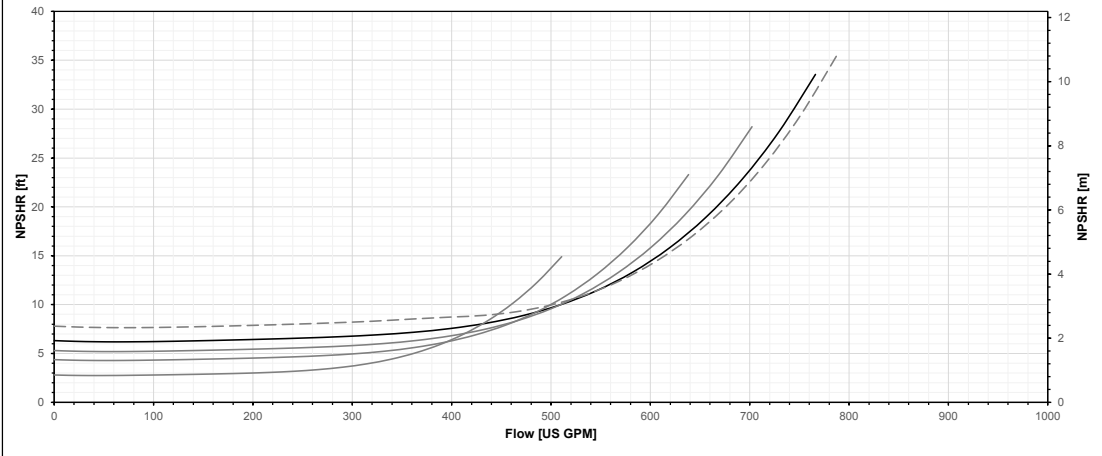
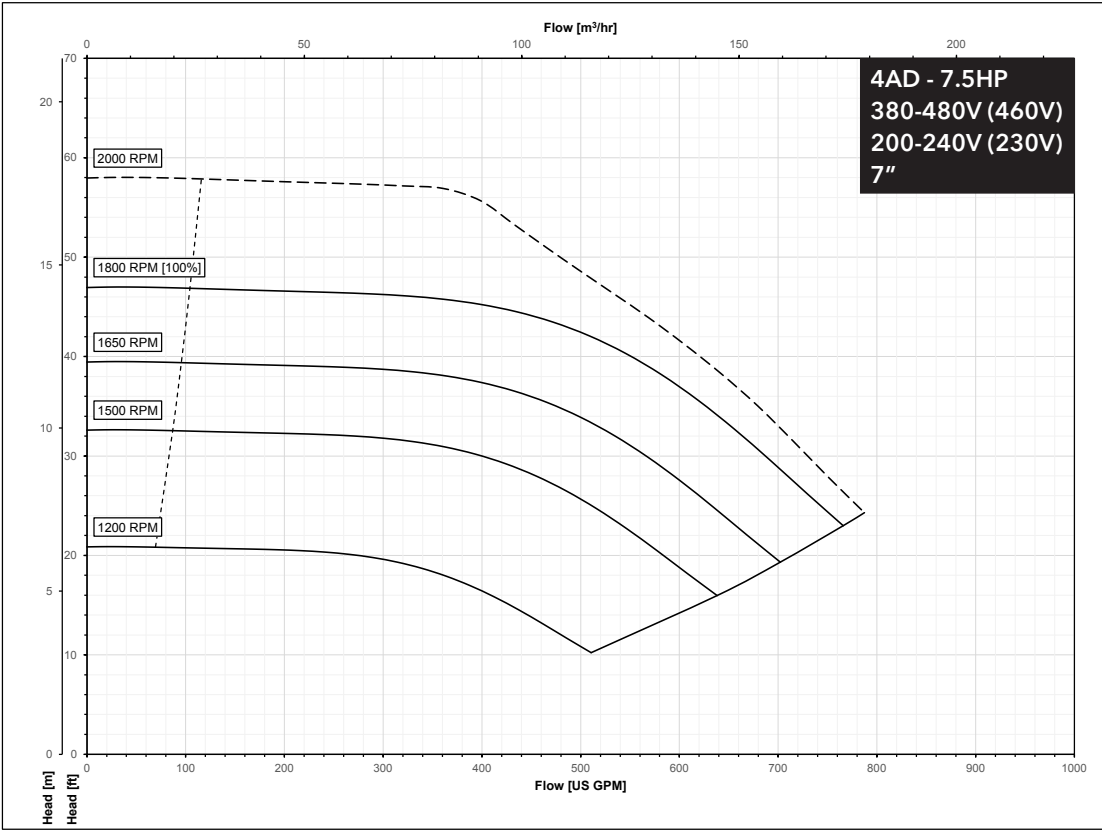

e-1510X PERFORMANCE CURVES FOR LOW SPEED MODELS

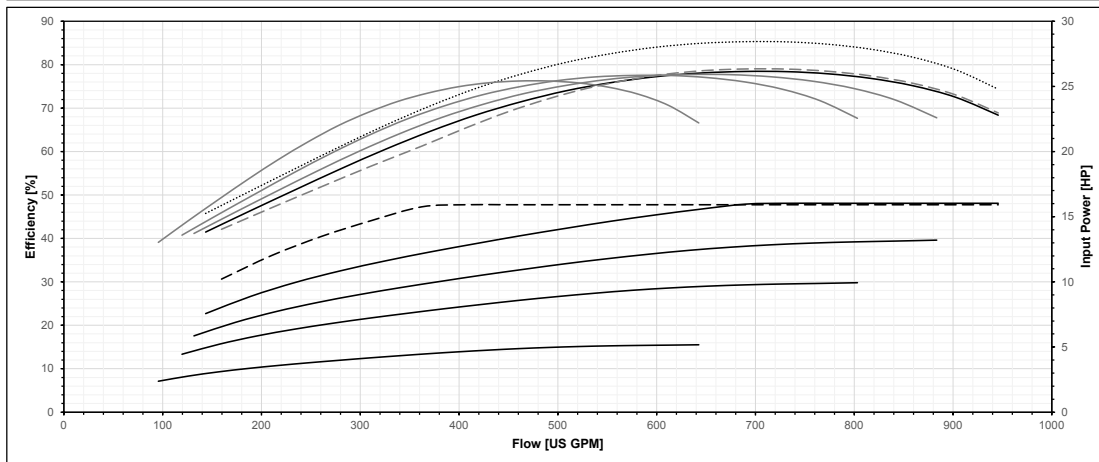
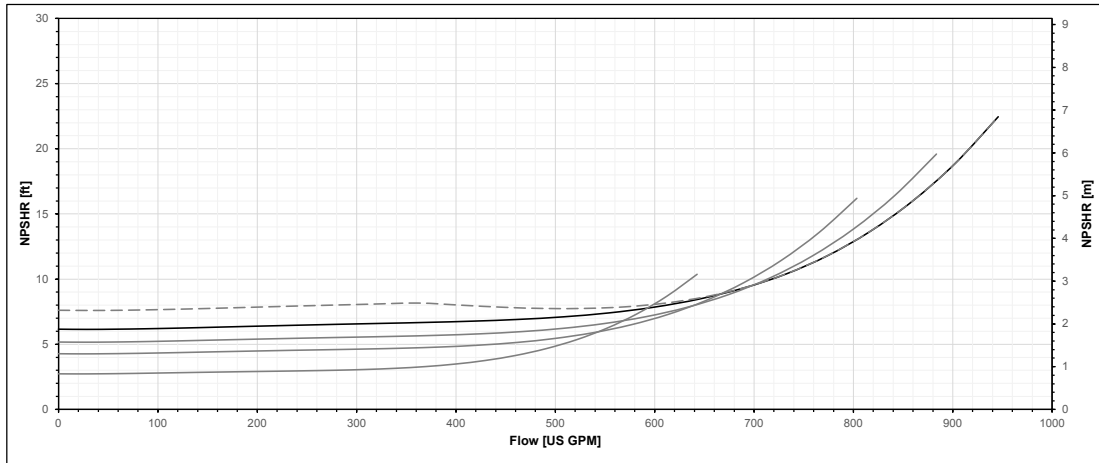
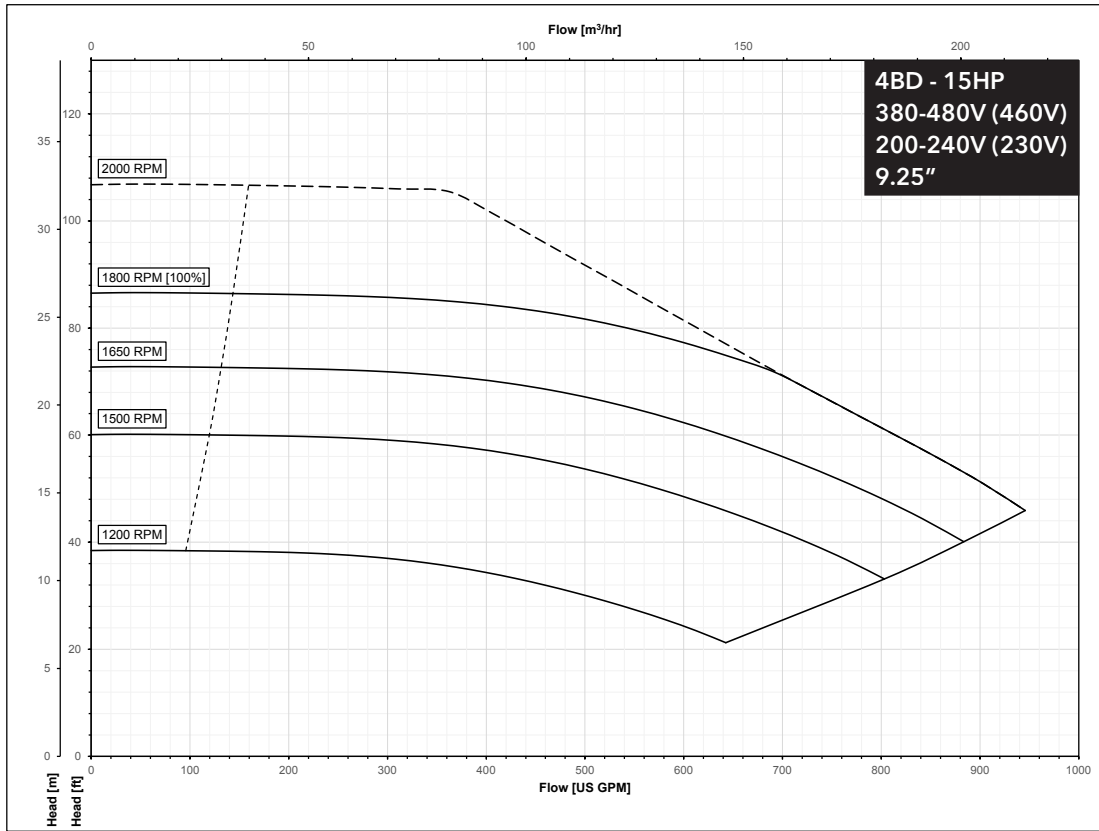

e-1510X PERFORMANCE CURVES FOR LOW SPEED MODELS

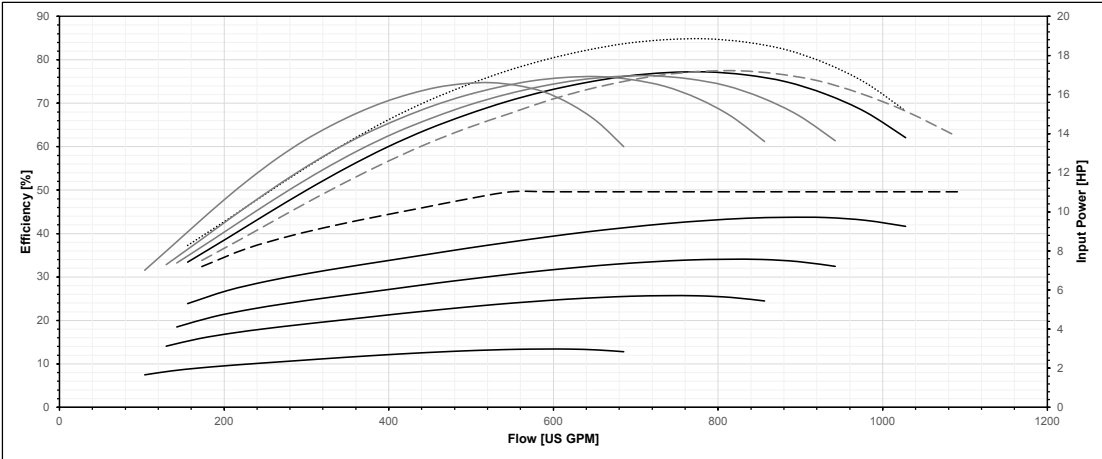
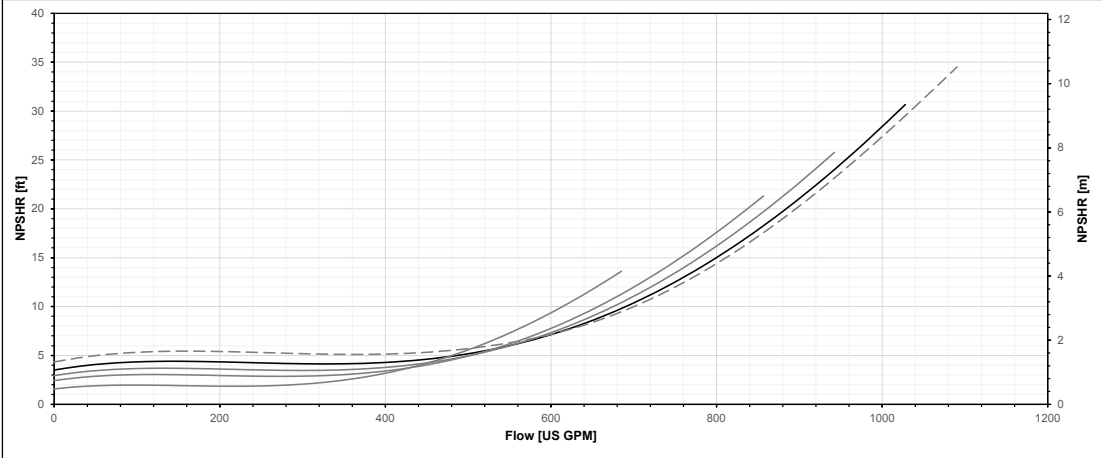
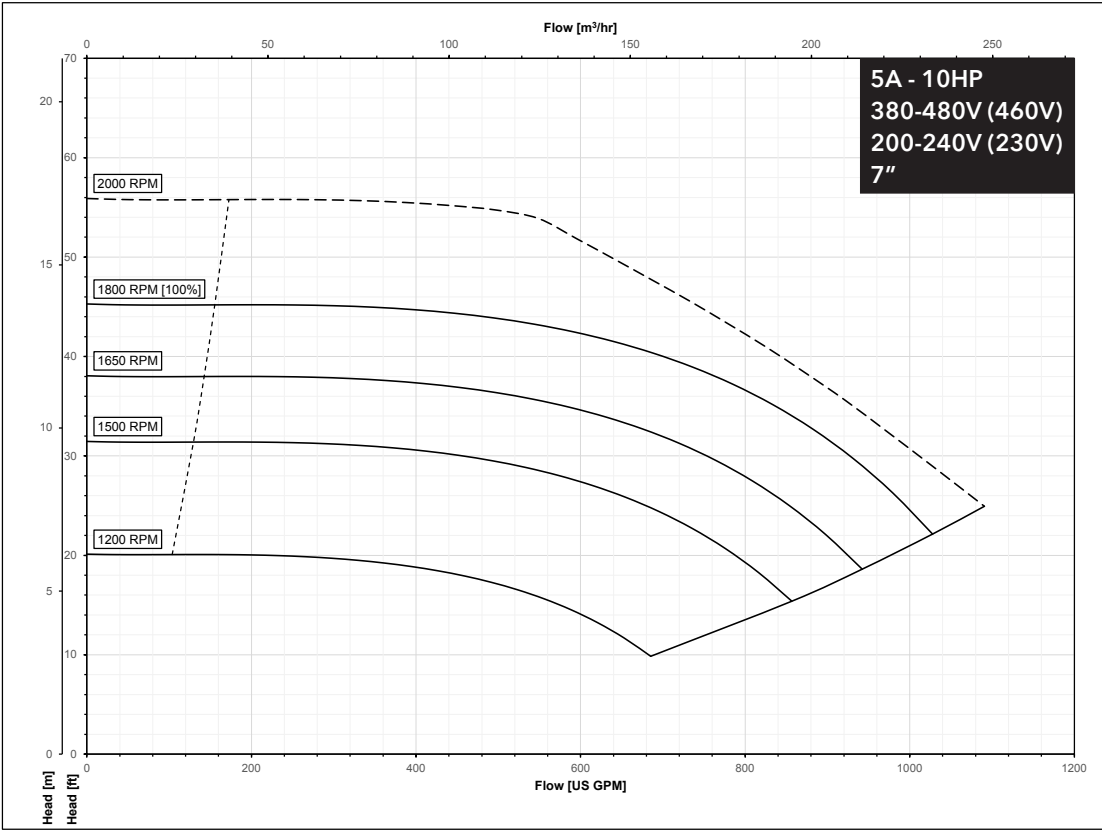

e-1510X PERFORMANCE CURVES FOR LOW SPEED MODELS

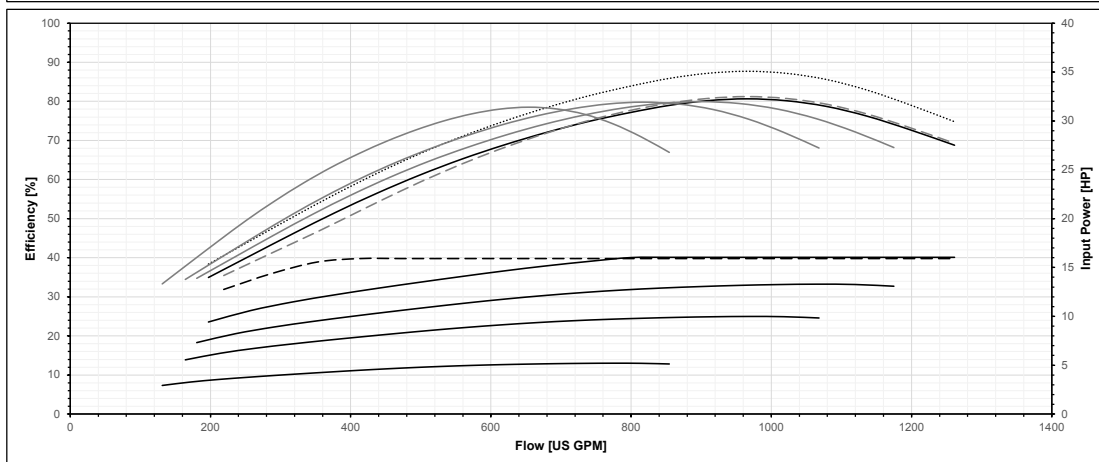
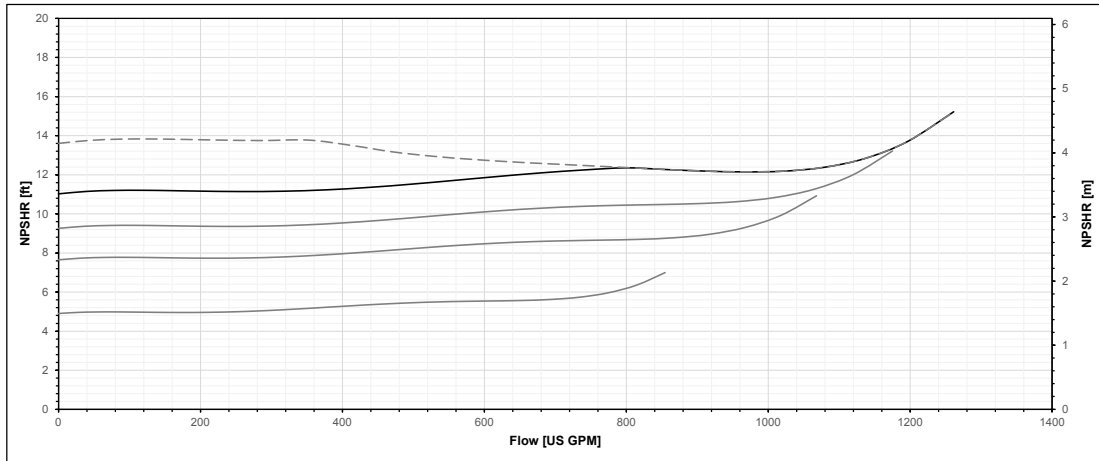
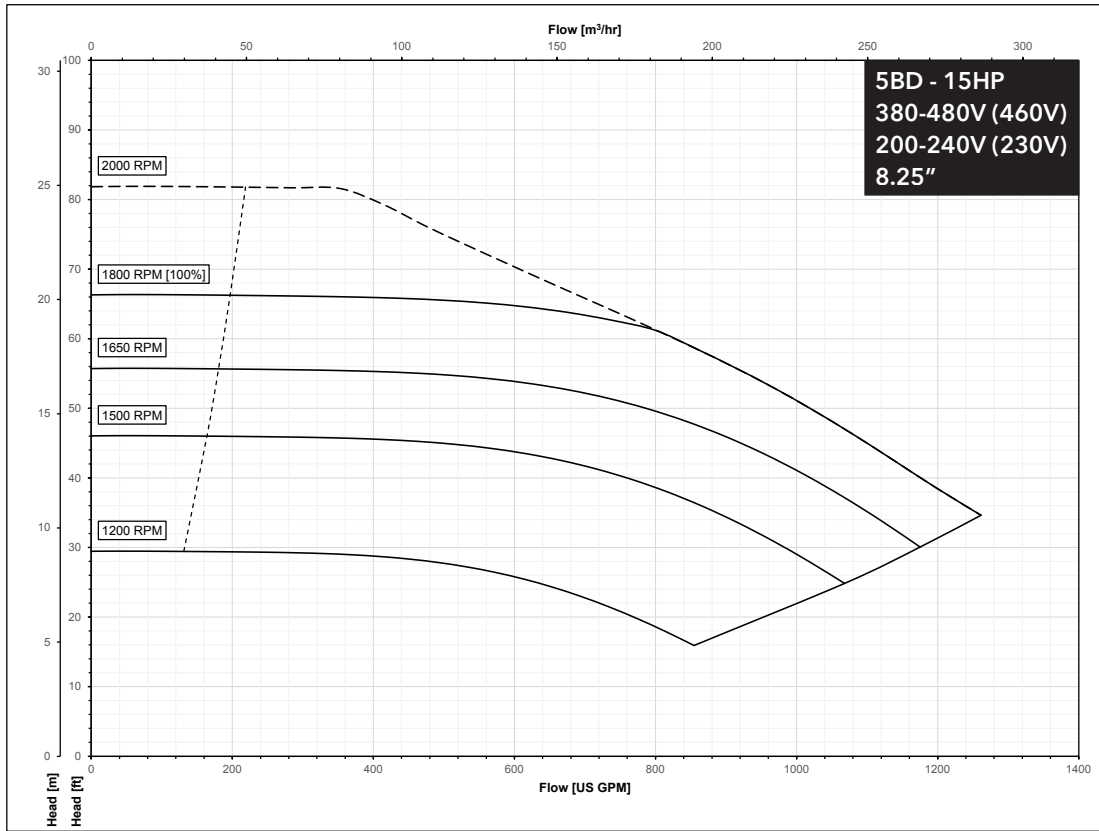

e-1510X PERFORMANCE CURVES FOR LOW SPEED MODELS

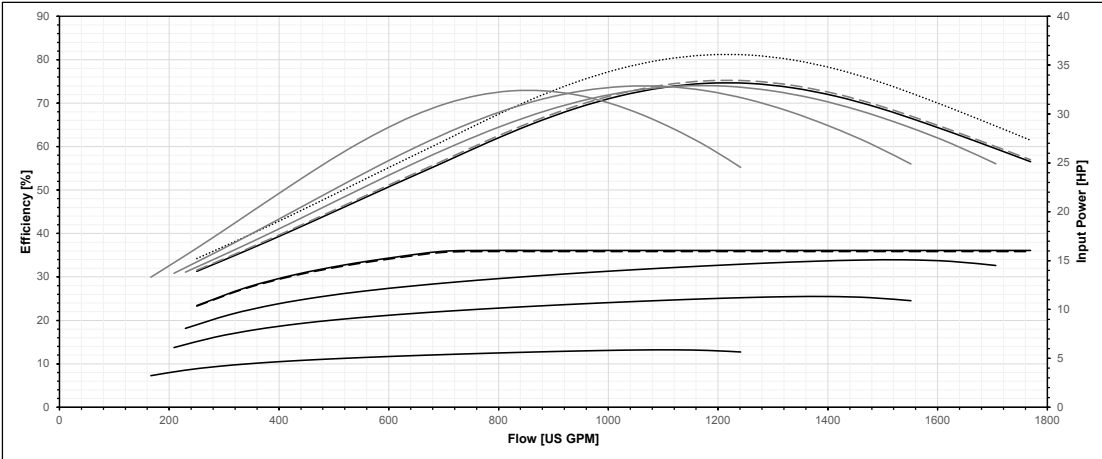
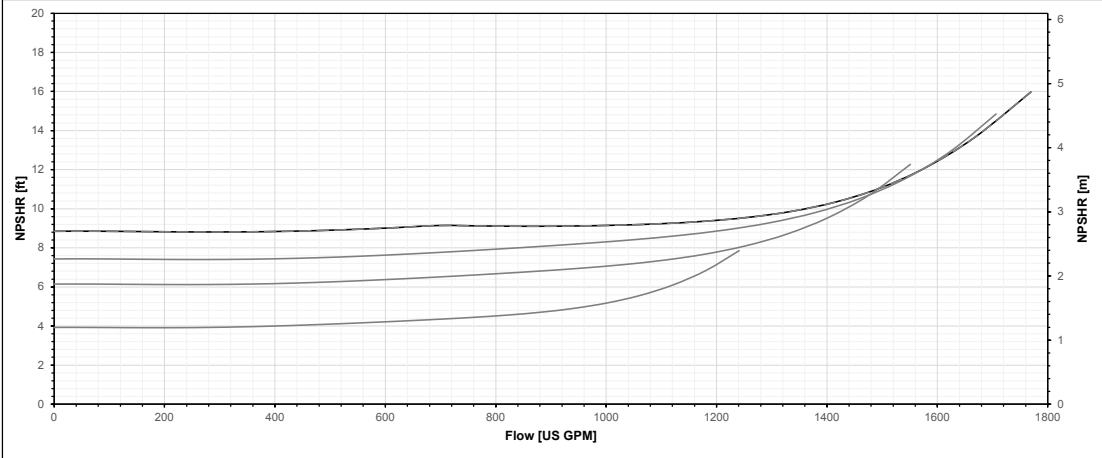
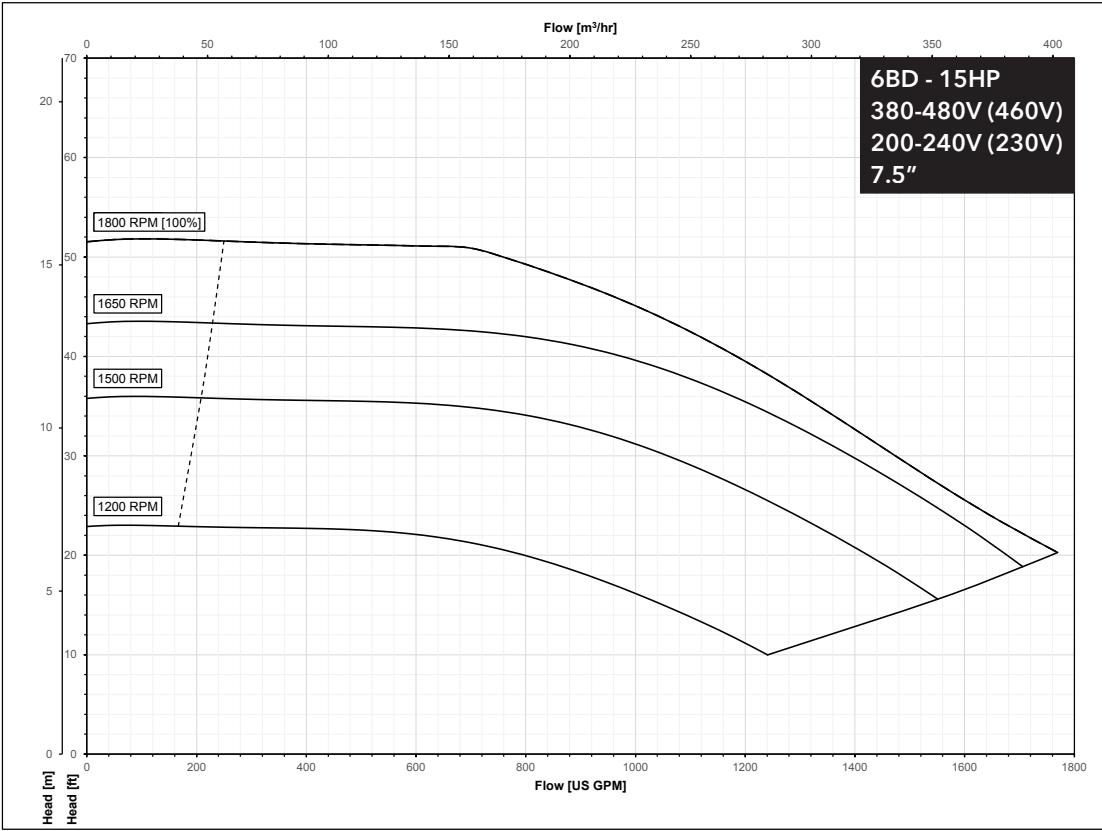

e-1510X PERFORMANCE CURVES FOR LOW SPEED MODELS

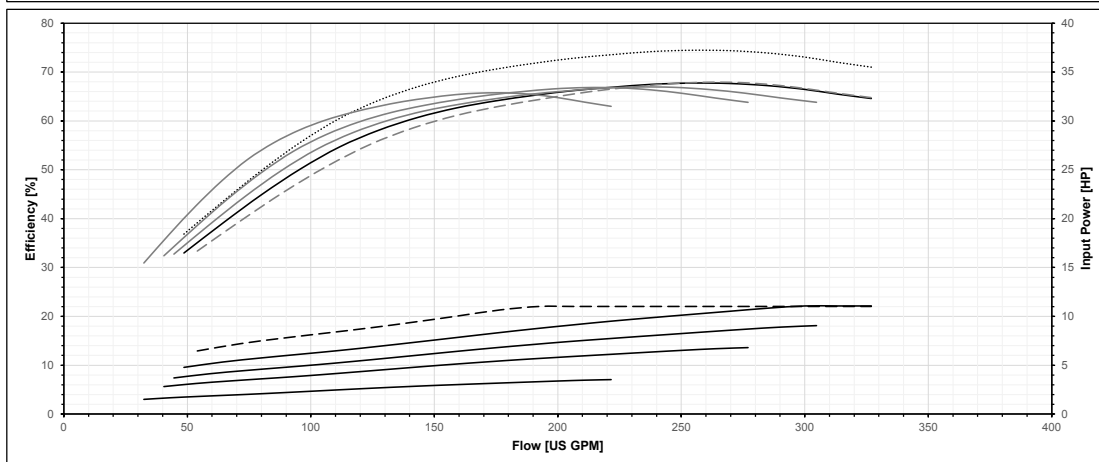
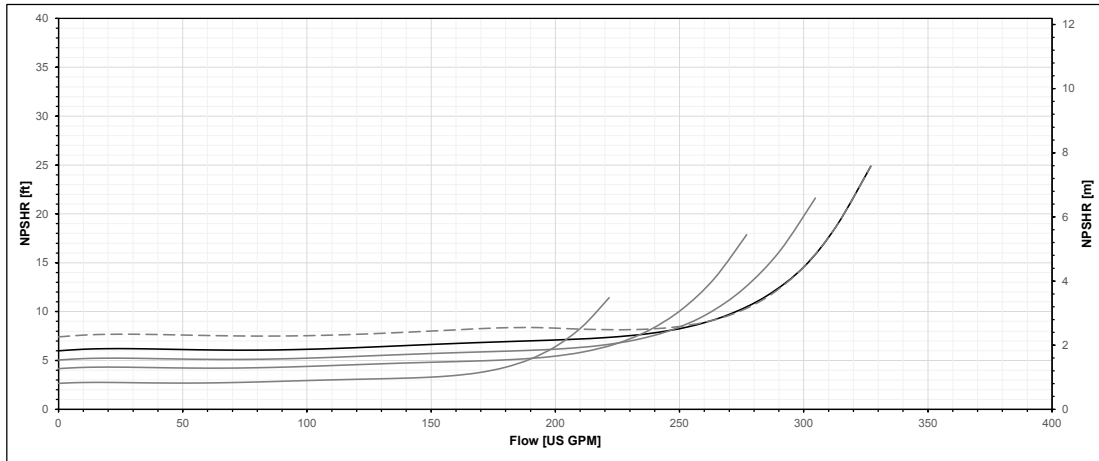
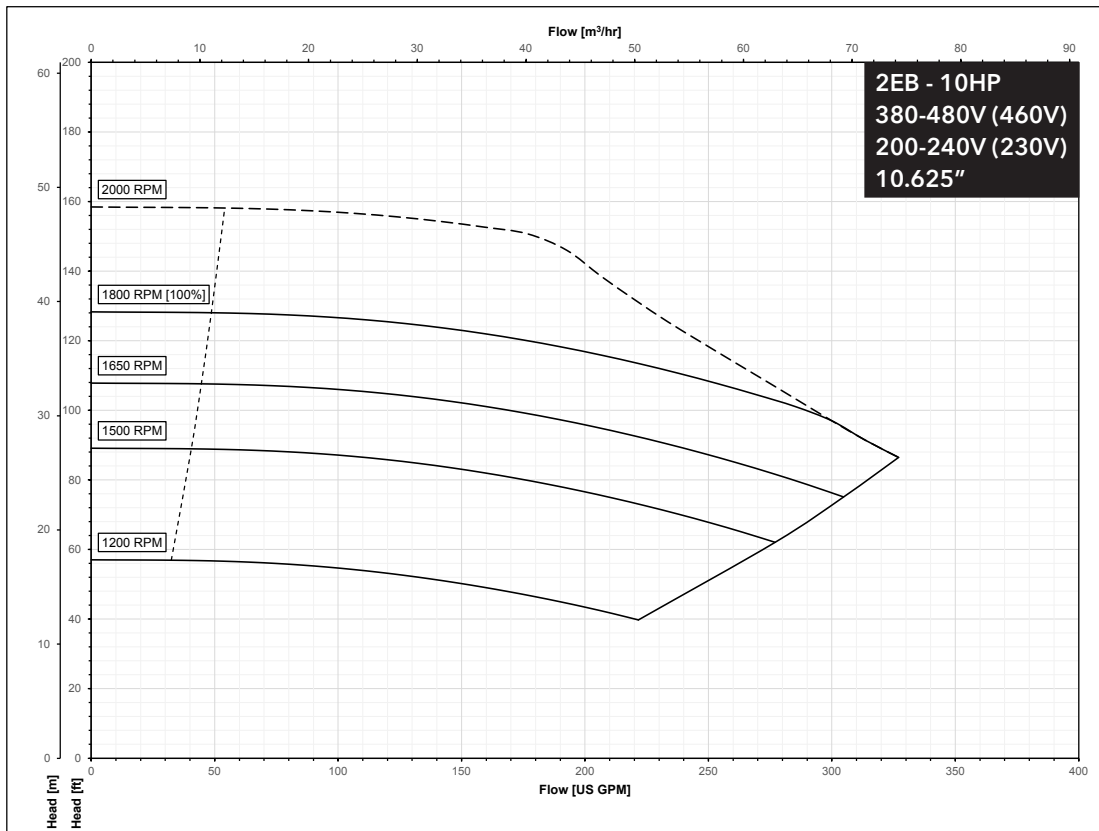

e-1510X PERFORMANCE CURVES FOR LOW SPEED MODELS

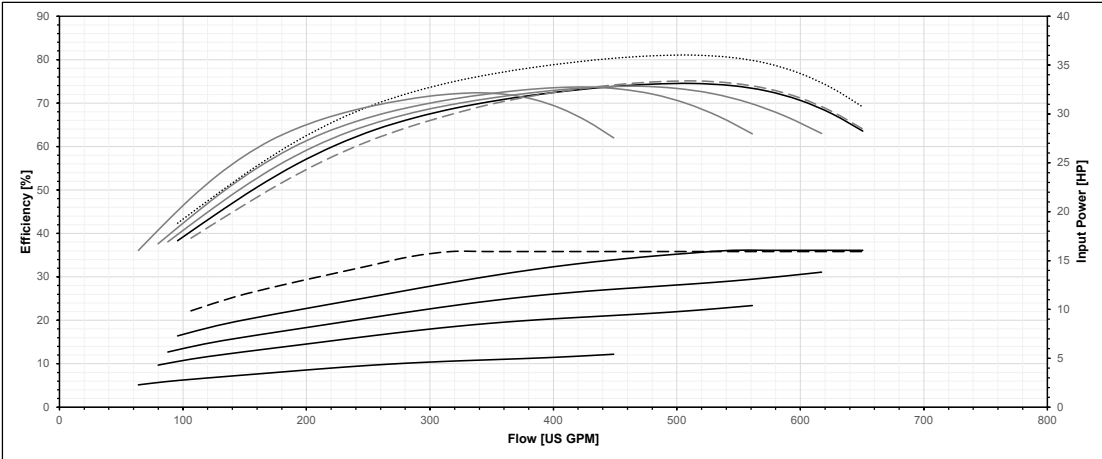
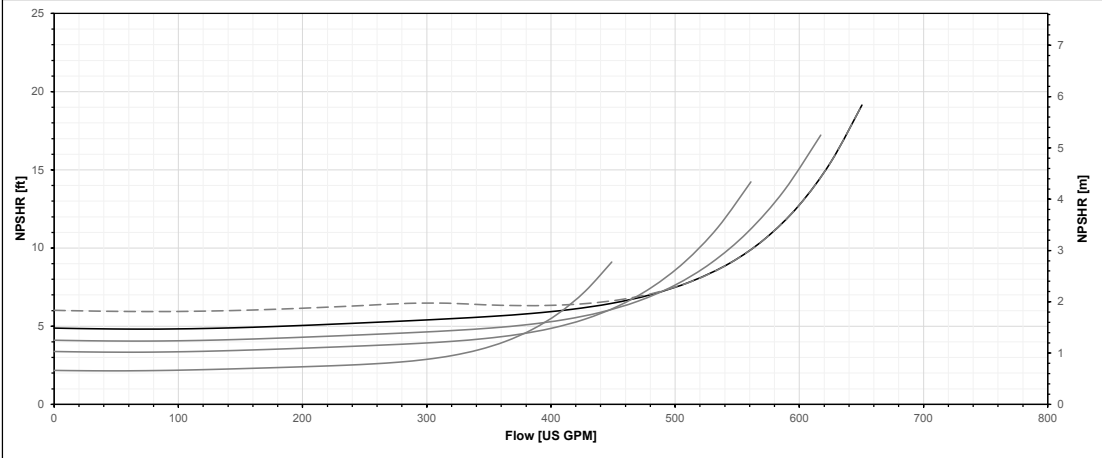
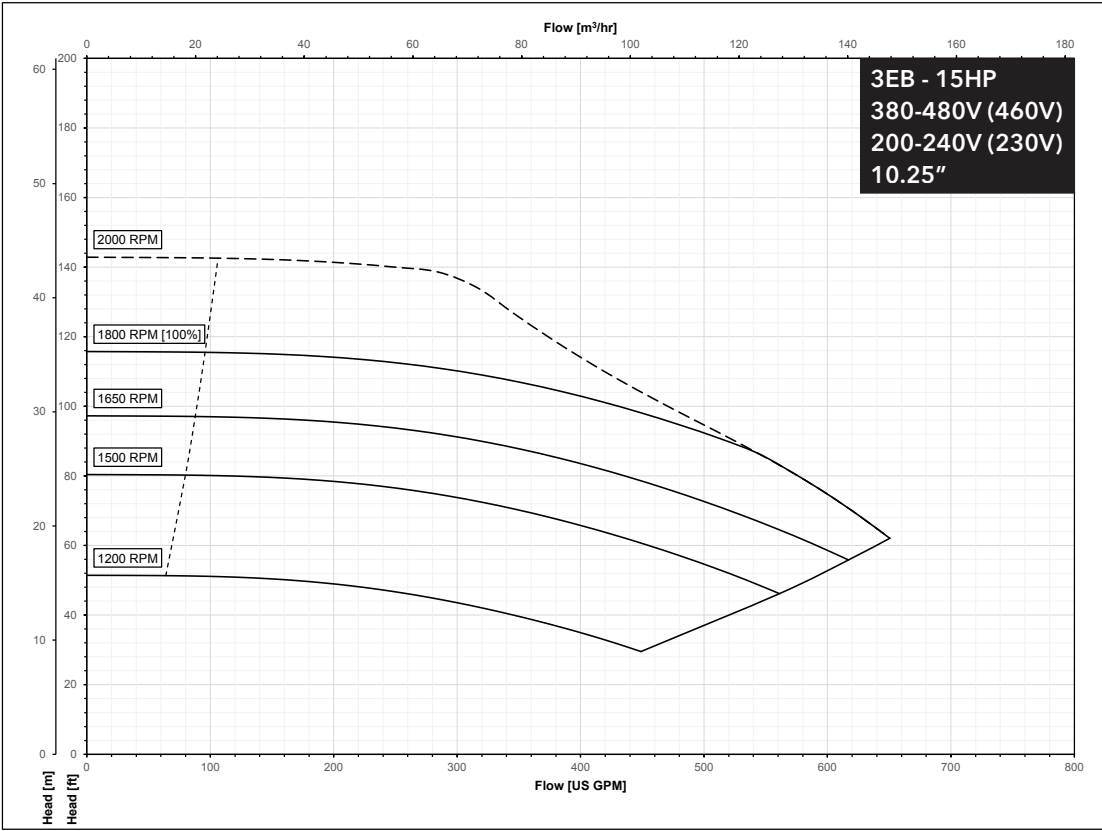

e-1510X PERFORMANCE CURVES FOR LOW SPEED MODELS

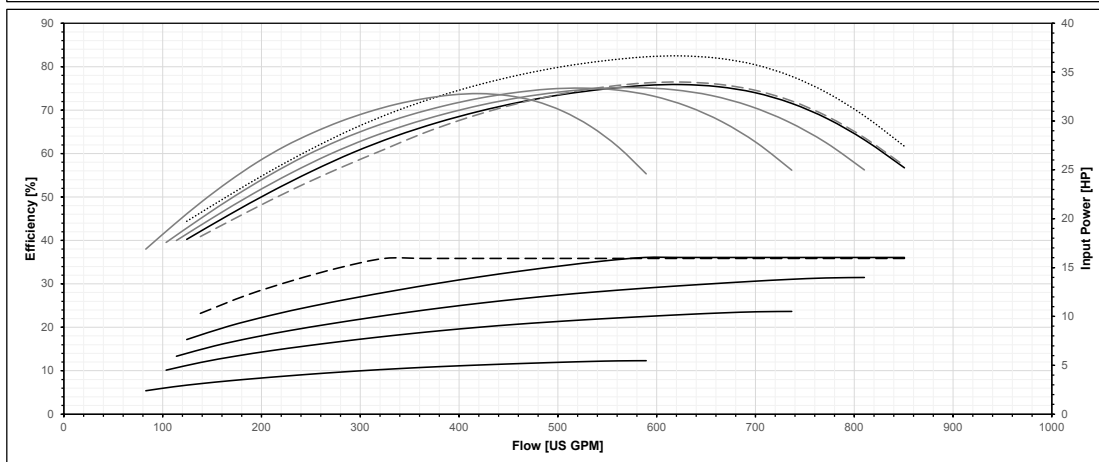
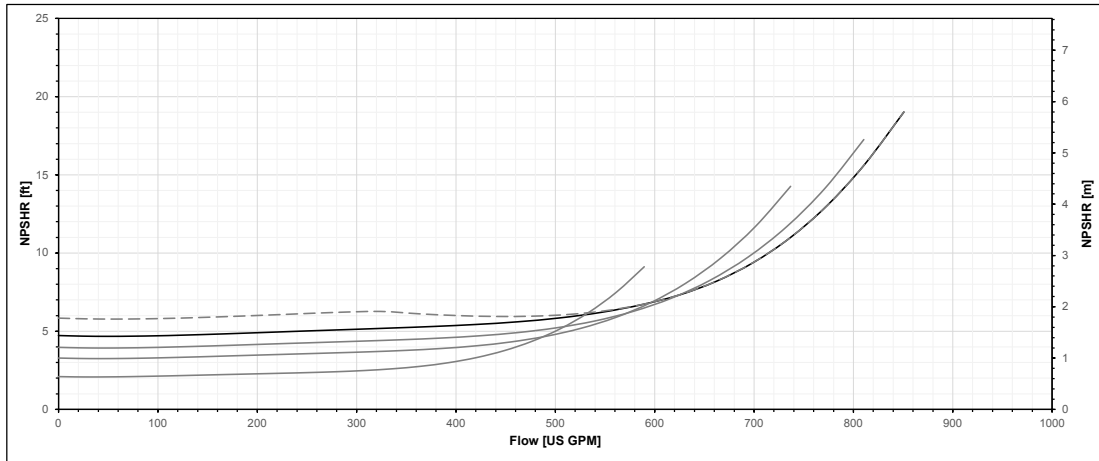
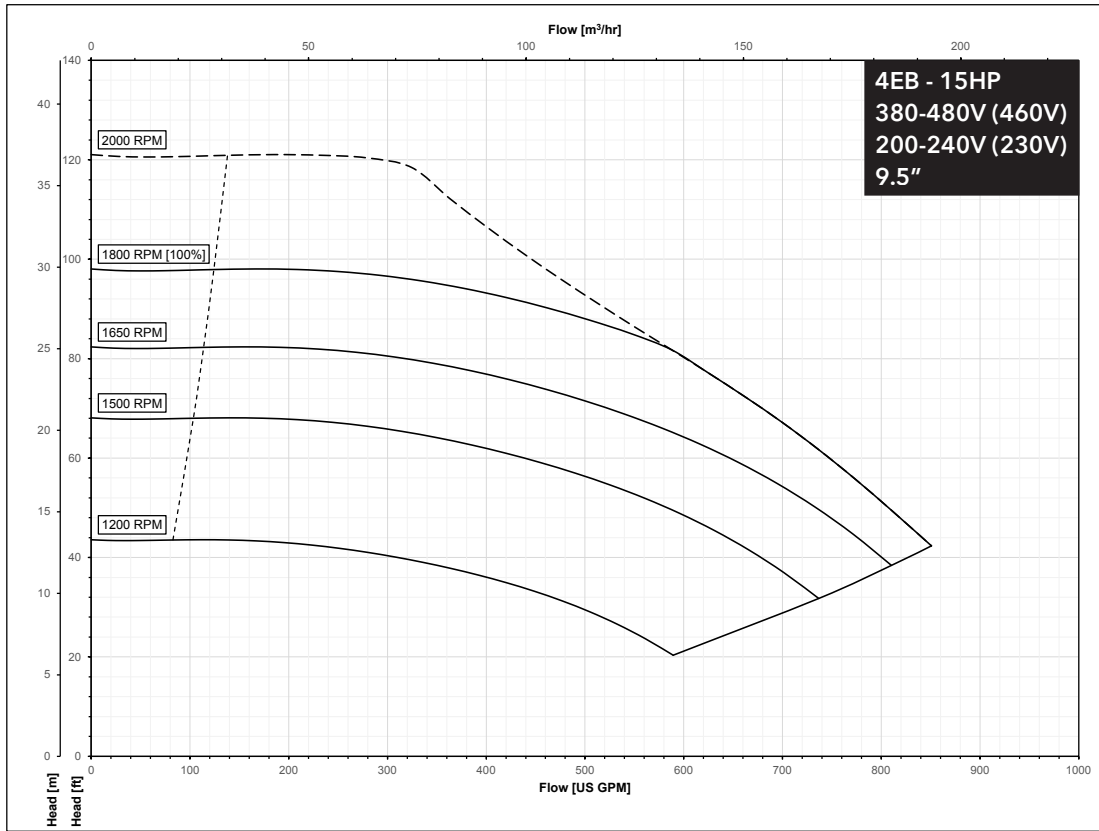

e-1510X PERFORMANCE CURVES FOR LOW SPEED MODELS

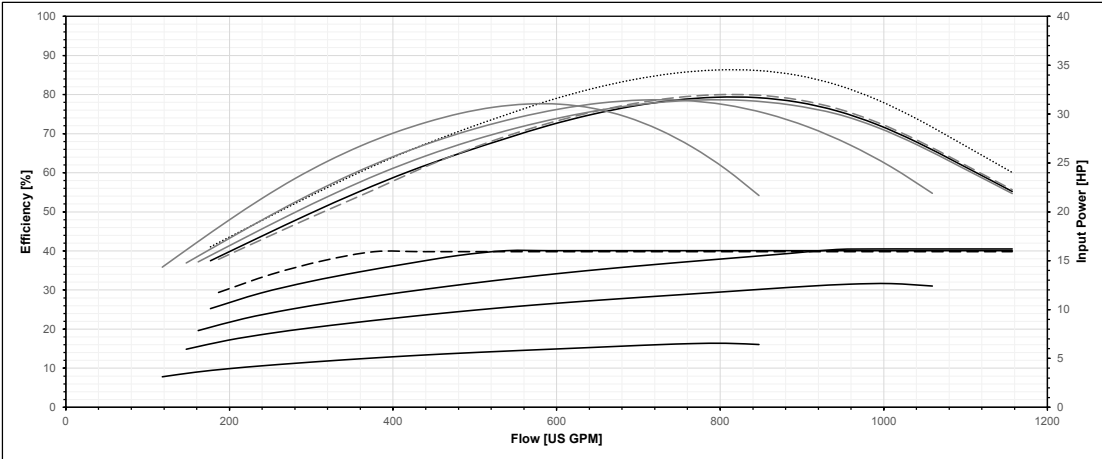
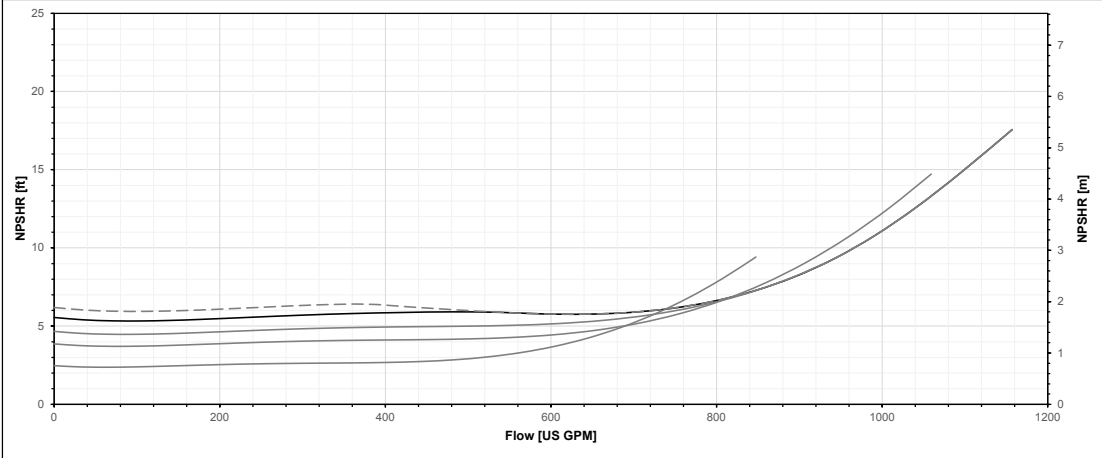
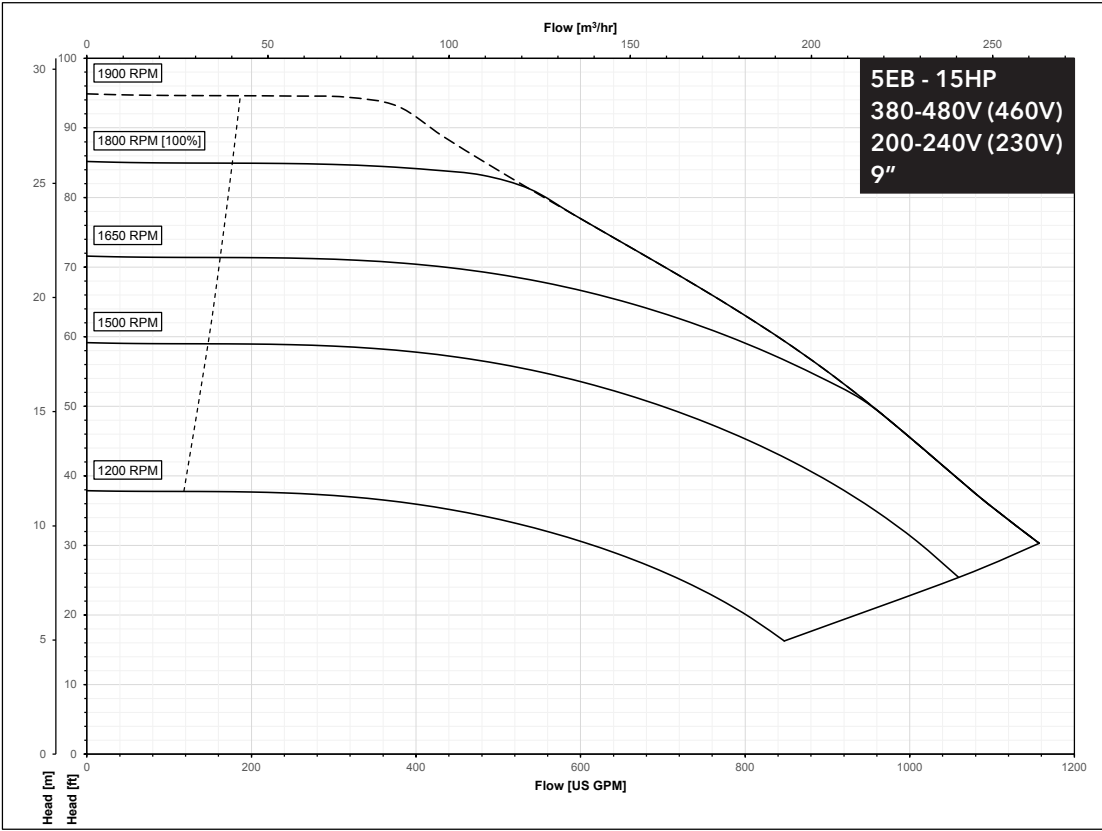

e-1510X PERFORMANCE CURVES FOR LOW SPEED MODELS

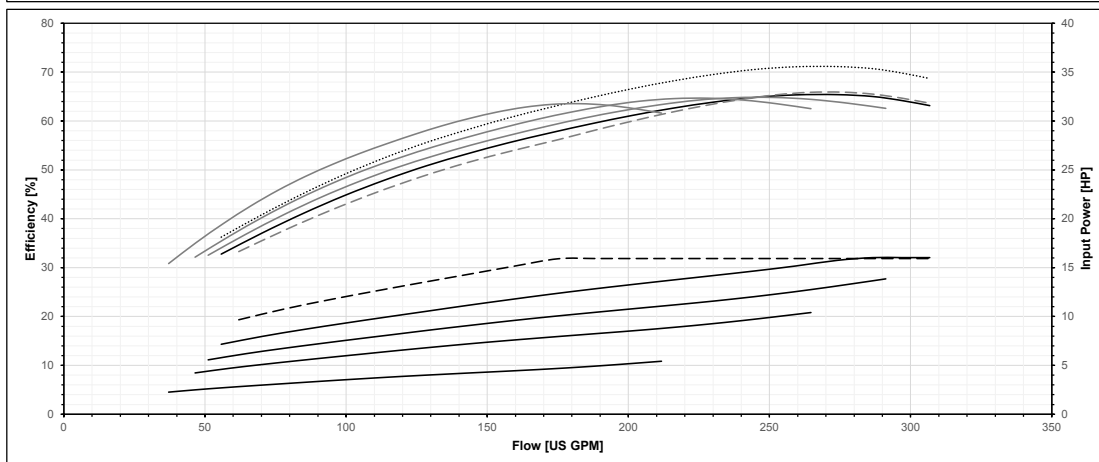
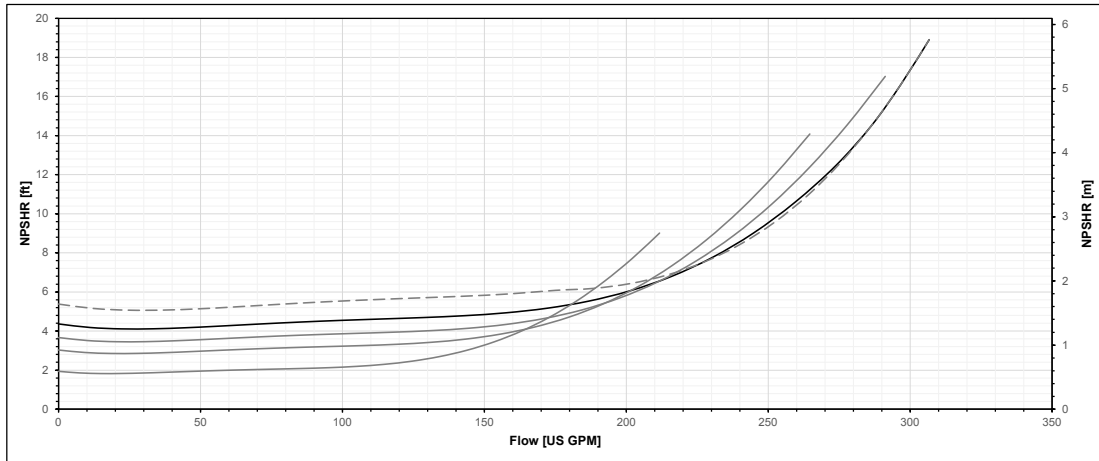
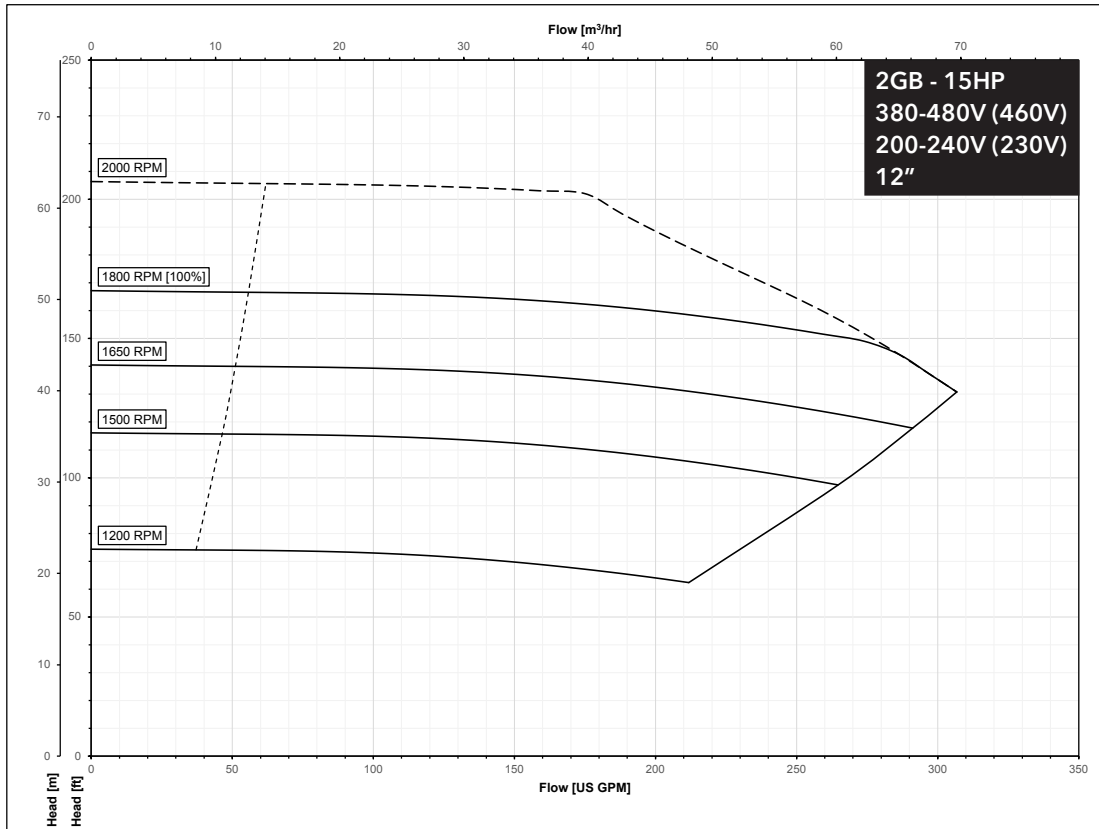

e-1510X PERFORMANCE CURVES FOR LOW SPEED MODELS

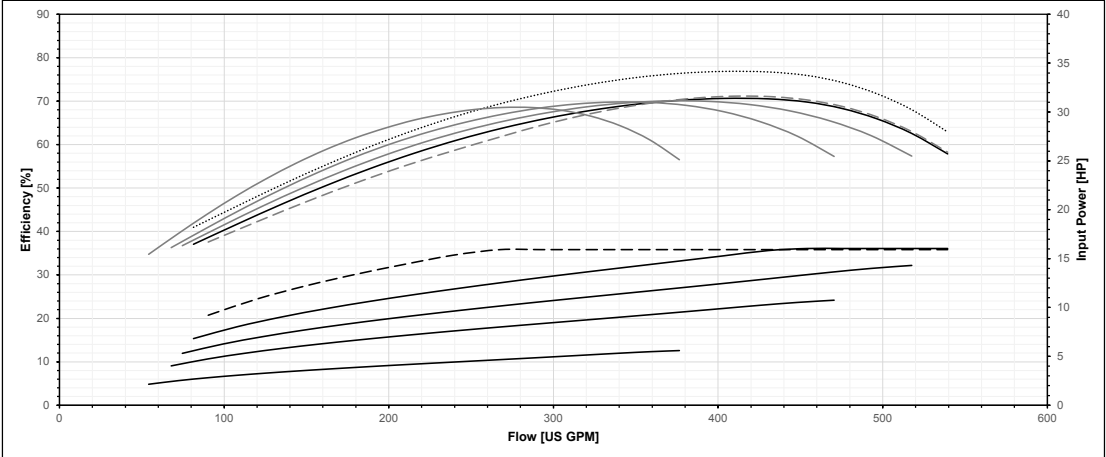
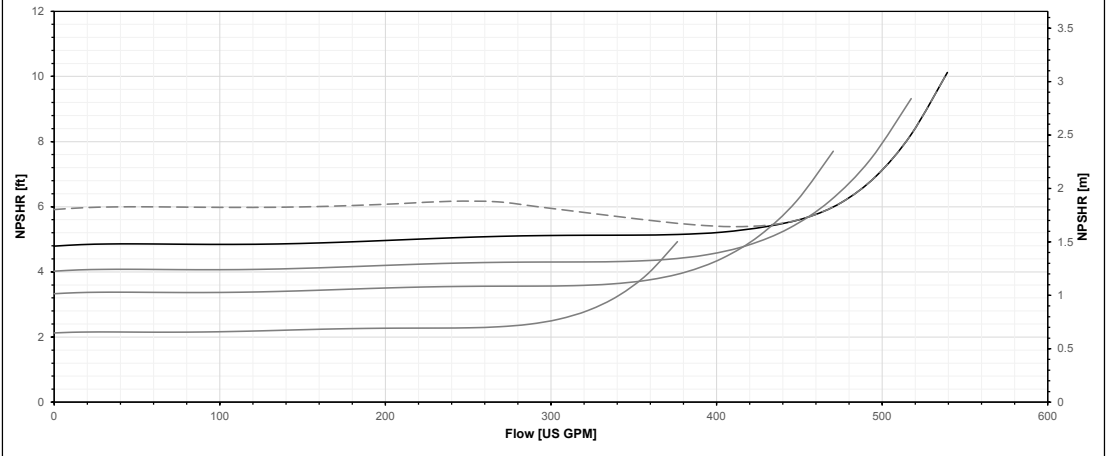
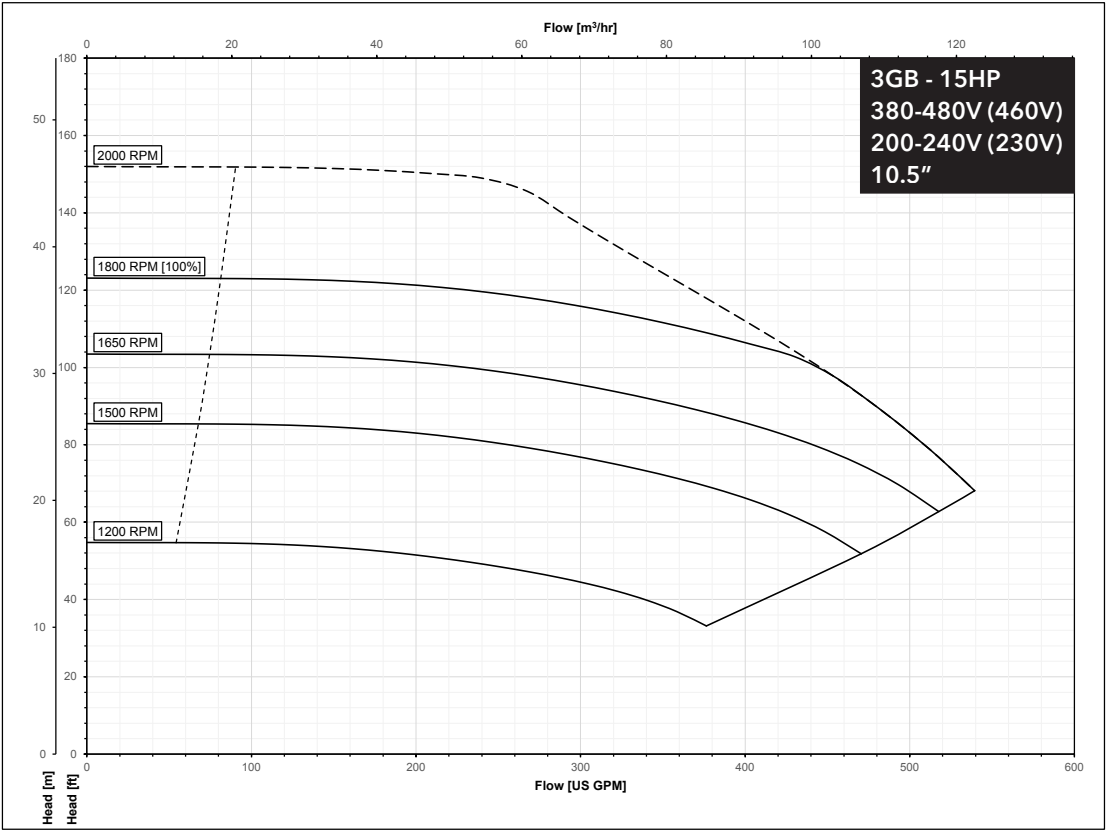

e-1510X PERFORMANCE CURVES FOR LOW SPEED MODELS

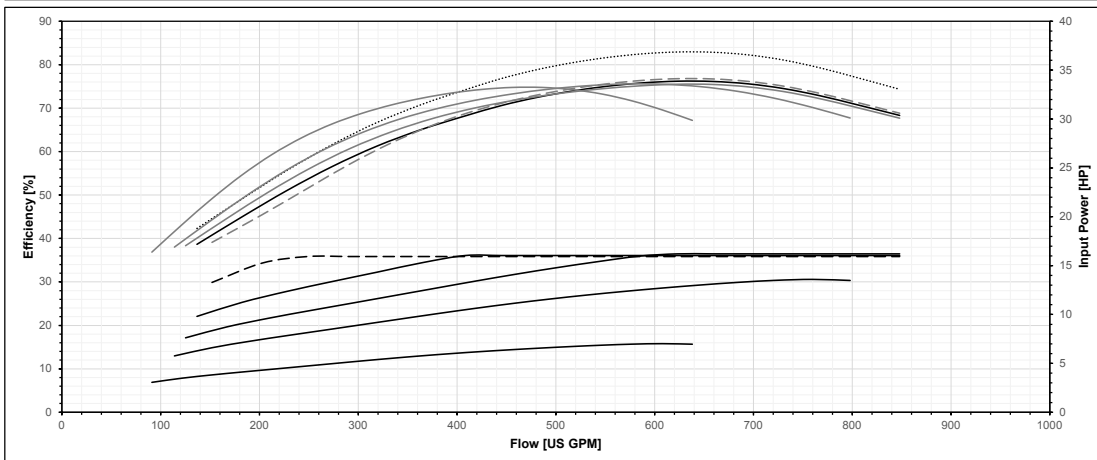
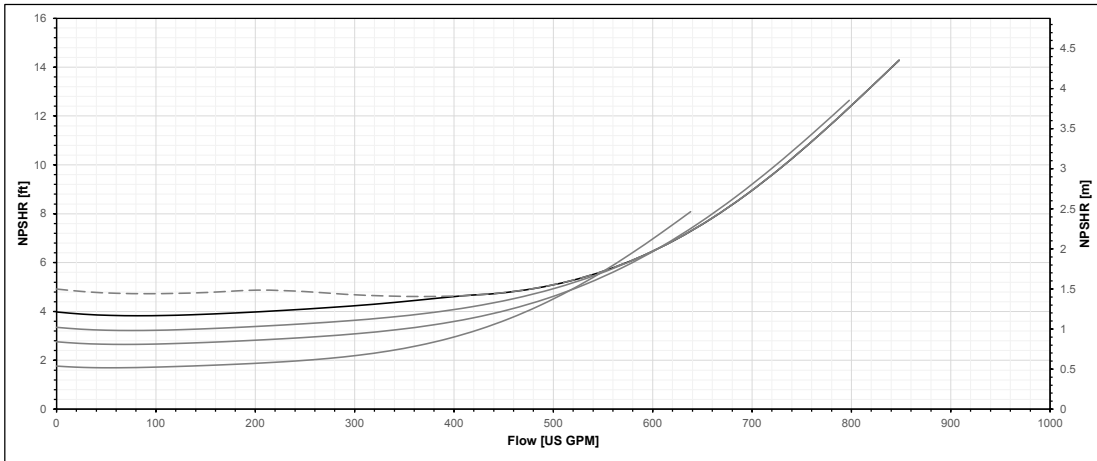
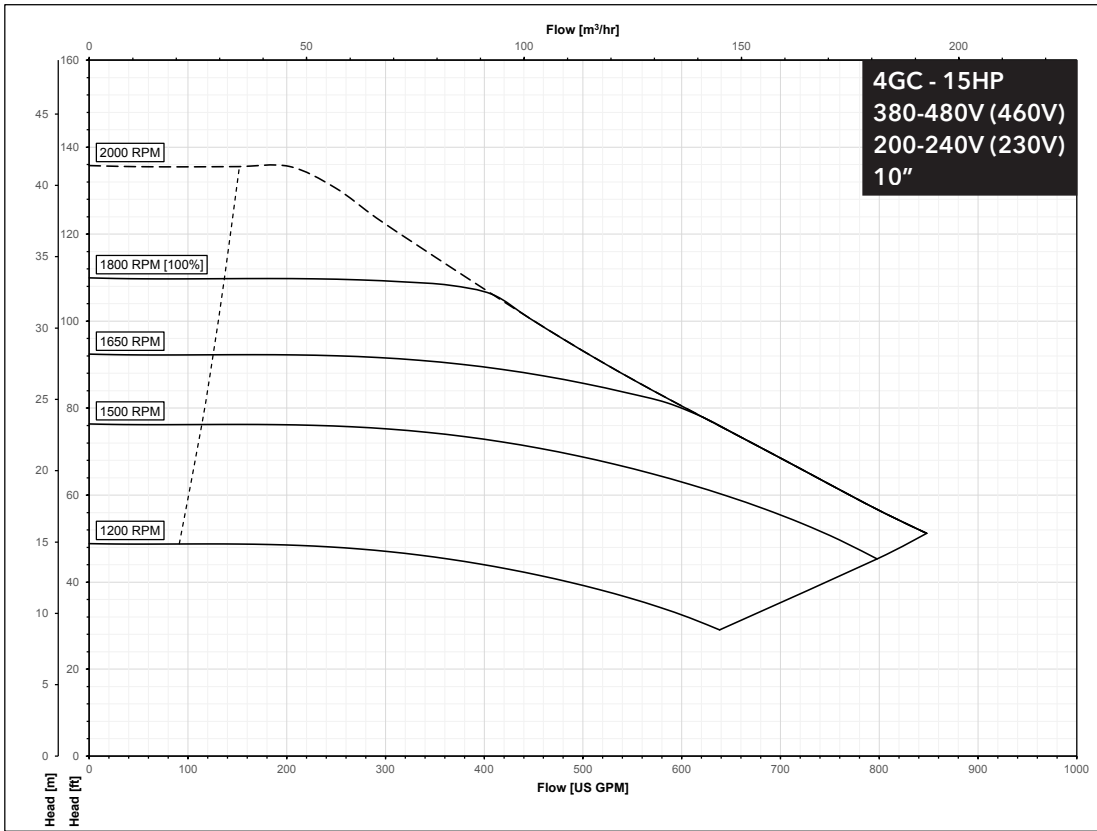

MATERIALS OF CONSTRUCTION

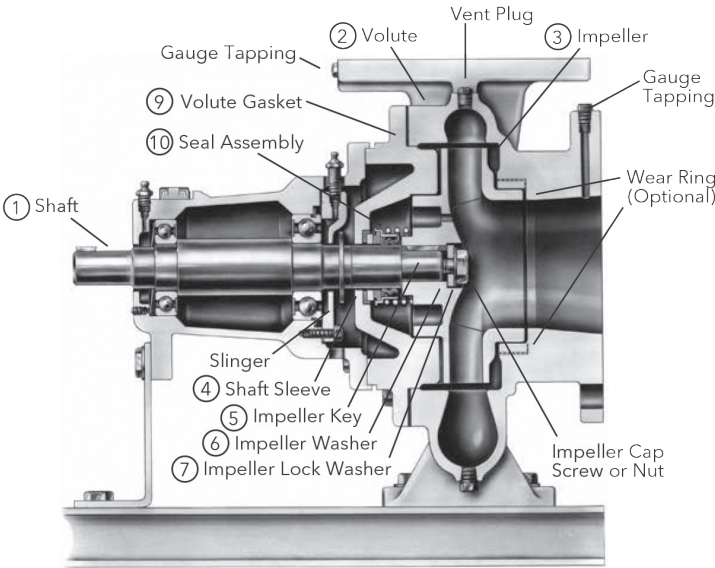

Standard Configuration

#	DESCRIPTION	MATERIAL
1	Shaft	ASTM 108 Grade 1144
2	Volute	Cast Iron ASTM A48 Class 30B or Ductile Iron
3	Impeller	ASTM A743 Grade CF8 - 304 Stainless Steel
4	Shaft Sleeve	ASTM 312 Grade TP304 - 304 Stainless Steel
5	Impeller Key	#304 Stainless Steel
6	Impeller Washer	Steel
7	Impeller Lock Washer	#304 Stainless Steel (18-8 XL FRM)
8	Impeller Cap Screw	#304 Stainless Steel
8	Impeller Nut	NA
9	Volute Gasket	Cellulose Fiber
10	Seal Assembly	Reference Seal Data Tables

SEAL ASSEMBLIES

Mechanical Seal Options

OPTIONS	BUNA/Carbon/Ceramic	EPR/SiC/SiC
Temperature Range	-20° to 225°F (-29° to 107°C)	-20° to 250°F (-29° to 121°C)
Maximum Pressure	175 PSI	175 PSI
pH Limitations	7.0 - 9.0	7.0 - 12.5
Elastomer	Buna	EPR (Ethylene Propylene Rubber)
Rotating Face	Carbon	Silicon Carbide
Stationary Face	Ceramic	Silicon Carbide
Hardware	Stainless Steel / Brass	Stainless Steel
Max Glycol/Water	50% / 50%	60% / 40%

e-1510X - DIMENSIONS AND WEIGHTS

(All dimensions in inches and weights in lbs. Do not use for construction purposes.)

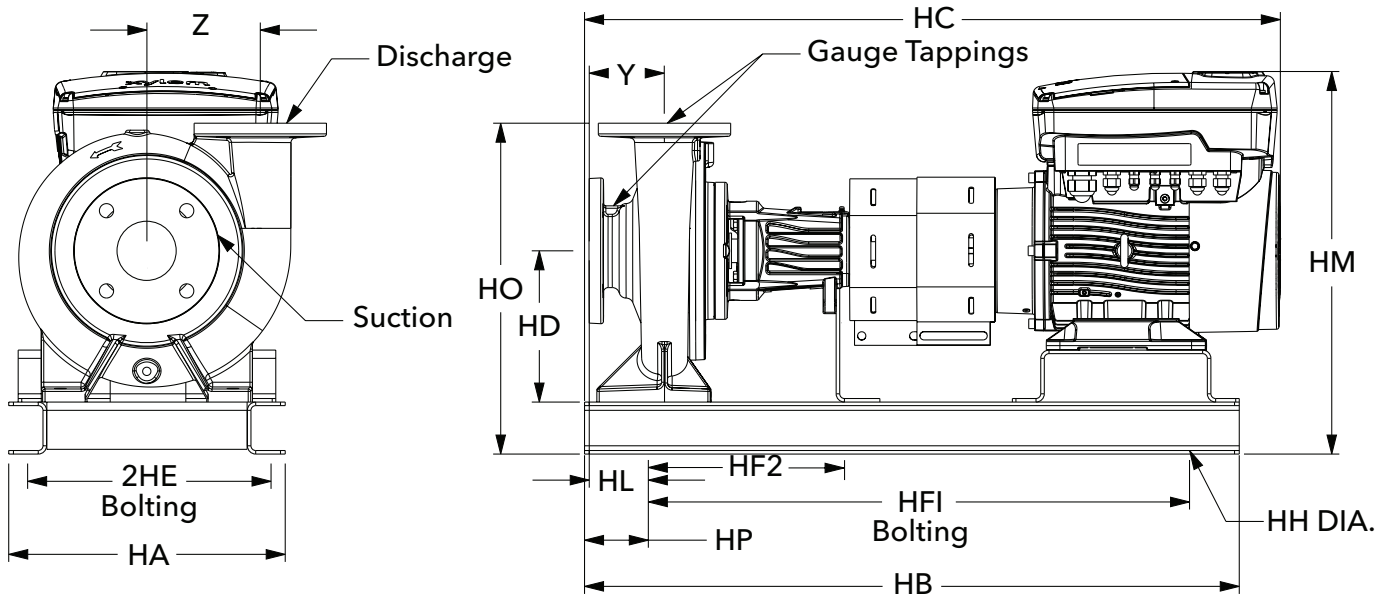

Dimensions - High speed (380-480V)

Pump Size	e-1510X PN	Frame	NEMA Frame	HA	HB	HC	HD	2HE	HF1	HF2	HH	HL	HM	HO	HP	Y	Z
1.25AD	1510XA1M4S...	S	213T	14.625 [371]	34.625 [879]	35.5 [902]	9.75 [248]	12.875 [327]	28.625 [727]	0 [0]	0.75 [19]	1.75 [44]	19.234 [489]	14.75 [375]	3 [76]	3.25 [83]	4.5 [114]
1.5AD	1510XB1N4S...	S	254T	14.625 [371]	39.375 [1000]	40.625 [1032]	10.75 [273]	12.875 [327]	33.375 [848]	0 [0]	0.75 [19]	11.688 [297]	22.917 [582]	16.75 [425]	3 [76]	3.125 [79]	4.625 [117]
1.25BC	1510XA4Q4S...	L	254T	16 [406]	46.5 [1181]	45.125 [1146]	12 [305]	14 [356]	36.5 [927]	18.25 [464]	0.875 [22]	2.938 [75]	24.167 [614]	20 [508]	5 [127]	3.25 [83]	5.5 [140]
1.5BC	1510XB4Q4S...	L	254T	16 [406]	46.5 [1181]	45 [1143]	12 [305]	14 [356]	36.5 [927]	18.5 [470]	0.875 [22]	2.813 [71]	24.167 [614]	18.5 [470]	5 [127]	3.109 [79]	5.75 [146]
2.5AC	1510XD2P4S...	S	254T	14.625 [371]	39.375 [1000]	42 [1067]	10.75 [273]	12.875 [327]	33.375 [848]	0 [0]	0.75 [19]	3 [76]	22.917 [582]	16.75 [425]	3 [76]	4.25 [108]	4.688 [119]
2AD	1510XC1N4S...	S	254T	14.625 [371]	39.375 [1000]	41.25 [1048]	10.75 [273]	12.875 [327]	33.275 [845]	0 [0]	0.75 [19]	2.188 [56]	22.917 [582]	17.25 [438]	3 [76]	3.5 [89]	4.75 [121]
2BD	1510XC5Q4S...	L	254T	16 [406]	46.5 [1181]	46.125 [1172]	12 [305]	14 [356]	36.5 [927]	18.25 [464]	0.875 [22]	3.813 [97]	24.167 [614]	19 [483]	5 [127]	4 [102]	5.875 [149]
3AD	1510XE1Q4S...	L	254T	16 [406]	46.5 [1181]	46.375 [1178]	12 [305]	14 [356]	36.5 [927]	18.25 [464]	0.875 [22]	4.063 [103]	24.167 [614]	18 [457]	5 [127]	4.125 [105]	5 [127]
4AD	1510XF1Q4S...	L	254T	16 [406]	46.5 [1181]	47.75 [1213]	12 [305]	14 [356]	36.5 [927]	18.25 [464]	0.875 [22]	5.438 [138]	24.167 [614]	19.5 [495]	5 [127]	4.938 [125]	5.75 [146]

e-1510X Series

e-1510X - DIMENSIONS AND WEIGHTS

(All dimensions in inches and weights in lbs. Do not use for construction purposes.)

Dimensions - High speed (200-240V)

Pump Size	e-1510X PN	Frame	NEMA Frame	HA	HB	HC	HD	2HE	HF1	HF2	HH	HL	HM	HO	HP	Y	Z
1.25AD	1510XA1M4R...	S	254T	14.625 [371]	39.375 [1000]	40.75 [1035]	10.75 [273]	12.875 [327]	33.375 [848]	0 [0]	0.75 [19]	1.75 [44]	22.917 [582]	15.75 [400]	3 [76]	3.25 [83]	4.5 [114]
1.5AD	1510XB1N4R...	S	254T	14.625 [371]	39.375 [1000]	40.625 [1032]	10.75 [273]	12.875 [327]	33.375 [848]	0 [0]	0.75 [19]	11.688 [297]	22.917 [582]	16.75 [425]	3 [76]	3.125 [79]	4.625 [117]
1.25BC	1510XA4N4R...	L	254T	16 [406]	46.5 [1181]	45.125 [1146]	12 [305]	14 [356]	36.5 [927]	18.25 [464]	0.875 [22]	2.938 [75]	24.167 [614]	20 [508]	5 [127]	3.25 [83]	5.5 [140]
1.5BC	1510XB4N4R...	L	254T	16 [406]	46.5 [1181]	45 [1143]	12 [305]	14 [356]	36.5 [927]	18.5 [470]	0.875 [22]	2.813 [71]	24.167 [614]	18.5 [470]	5 [127]	3.109 [79]	5.75 [146]
2.5AC	1510XD2N4R...	S	254T	14.625 [371]	39.375 [1000]	42 [1067]	10.75 [273]	12.875 [327]	33.375 [848]	0 [0]	0.75 [19]	3 [76]	22.917 [582]	16.75 [425]	3 [76]	4.25 [108]	4.688 [119]
2AD	1510XC1N4R...	S	254T	14.625 [371]	39.375 [1000]	41.25 [1048]	10.75 [273]	12.875 [327]	33.275 [845]	0 [0]	0.75 [19]	2.188 [56]	22.917 [582]	17.25 [438]	3 [76]	3.5 [89]	4.75 [121]
3AD	1510XE1N4R...	L	254T	16 [406]	46.5 [1181]	46.375 [1178]	12 [305]	14 [356]	36.5 [927]	18.25 [464]	0.875 [22]	4.063 [103]	24.167 [614]	18 [457]	5 [127]	4.125 [105]	5 [127]
4AD	1510XF1N4R...	L	254T	16 [406]	46.5 [1181]	47.75 [1213]	12 [305]	14 [356]	36.5 [927]	18.25 [464]	0.875 [22]	5.438 [138]	24.167 [614]	19.5 [495]	5 [127]	4.938 [125]	5.75 [146]

Dimensions - Low speed (380-480V)

Pump Size	e-1510X PN	Frame	NEMA Frame	HA	HB	HC	HD	2HE	HF1	HF2	HH	HL	HM	HO	HP	Y	Z
1.25AD	1510XA1J5S...	S	143T	12 [305]	28.75 [730]	29.5 [749]	9.75 [248]	10.25 [260]	22.5 [572]	0 [0]	0.75 [19]	3.125 [79]	17.368 [441]	14.75 [375]	3 [76]	3.25 [83]	4.5 [114]
1.5AD	1510XB1J5S...	S	143T	12 [305]	28.75 [730]	29.375 [746]	9.75 [248]	10.25 [260]	22.5 [572]	0 [0]	0.75 [19]	11.688 [297]	17.368 [441]	15.75 [400]	3 [76]	3.125 [79]	4.625 [117]
1.25BC	1510XA4K5S...	L	213T	14.625 [371]	39.375 [1000]	39.875 [1013]	10.75 [273]	12.875 [327]	33.375 [848]	0 [0]	0.75 [19]	1.813 [46]	20.234 [514]	18.75 [476]	3 [76]	3.25 [83]	5.5 [140]
1.5BC	1510XB4L5S...	S	213T	14.625 [371]	34.625 [879]	36.875 [937]	10.75 [273]	12.875 [327]	28.625 [727]	0 [0]	0.75 [19]	1.688 [43]	20.234 [514]	17.25 [438]	3 [76]	3.109 [79]	5.75 [146]
2.5AC	1510XD2N5S...	S	213T	14.625 [371]	34.625 [879]	36.75 [933]	9.75 [248]	12.875 [327]	28.625 [727]	0 [0]	0.75 [19]	3 [76]	19.234 [489]	15.75 [400]	3 [76]	4.25 [108]	4.688 [119]
2AD	1510XC1J5S...	S	143T	12 [305]	28.34 [720]	29 [737]	9.75 [248]	10.25 [260]	22.5 [572]	0 [0]	0.75 [19]	3.563 [90]	17.368 [441]	16.25 [413]	3 [76]	3.5 [89]	4.75 [121]
2BD	1510XC5L5S...	S	213T	14.625 [371]	34.625 [879]	36.5 [927]	10.75 [273]	12.875 [327]	28.625 [727]	0 [0]	0.75 [19]	2.688 [68]	20.234 [514]	17.75 [451]	3 [76]	4 [102]	5.875 [149]
2.5BB	1510XD11R5S...	L	254T	16 [406]	46.5 [1181]	46.125 [1172]	12 [305]	14 [356]	36.5 [927]	18.25 [464]	0.875 [22]	3.875 [98]	24.167 [614]	18.75 [476]	5 [127]	4 [102]	6 [152]
3AD	1510XE1K5S...	L	215T	14.625 [371]	39.375 [1000]	42.625 [1083]	9.75 [248]	12.875 [327]	33.625 [854]	0 [0]	0.75 [19]	2.938 [75]	19.234 [489]	15.75 [400]	3 [76]	4.125 [105]	5 [127]
3BD	1510XE5M5S...	S	254T	14.625 [371]	39.375 [1000]	42.75 [1086]	10.75 [273]	12.875 [327]	33.375 [848]	0 [0]	0.75 [19]	3.688 [94]	22.917 [582]	18.25 [464]	3 [76]	4.75 [121]	6.125 [156]
4AD	1510XF1L5S...	S	213T	14.625 [371]	34.625 [879]	38.125 [968]	10.75 [273]	12.875 [327]	28.625 [727]	0 [0]	0.75 [19]	4.313 [110]	20.234 [514]	18.25 [464]	3 [76]	4.938 [125]	5.75 [146]
4BD	1510XF5M5S...	S	254T	14.625 [371]	39.375 [1000]	43 [1092]	12.75 [324]	12.875 [327]	33.375 [848]	0 [0]	0.75 [19]	4 [102]	24.917 [633]	20.75 [527]	3 [76]	5 [127]	7 [178]
5A	1510XG3R5S...	L	254T	16 [406]	46.5 [1181]	49.125 [1248]	14 [356]	14 [356]	36.5 [927]	18.25 [464]	0.875 [22]	6.875 [175]	26.167 [665]	22.5 [572]	5 [127]	5.813 [148]	6.25 [159]
5BD	1510XG5M5S...	S	254T	16 [406]	46.5 [1181]	44.375 [1127]	15 [381]	14 [356]	36.5 [927]	18.25 [464]	0.875 [22]	4.563 [116]	27.167 [690]	25 [635]	5 [127]	6 [152]	7.5 [191]
6BD	1510XH5M5S...	L	254T	16 [406]	46.5 [1181]	50.625 [1286]	15 [381]	14 [356]	36.5 [927]	18.25 [464]	0.875 [22]	8.375 [213]	27.167 [690]	25.5 [648]	5 [127]	7 [178]	8.25 [210]
2EB	1510XC6R5S...	S	254T	16 [406]	42.25 [1073]	42.5 [1080]	14 [356]	14 [356]	32.25 [819]	16.125 [410]	0.875 [22]	6.5 [165]	26.167 [665]	22 [559]	5 [127]	5.5 [140]	6.5 [165]
3EB	1510XE6M5S...	S	254T	16 [406]	42.25 [1073]	42.625 [1083]	14 [356]	14 [356]	32.25 [819]	16.125 [410]	0.875 [22]	6.688 [170]	26.167 [665]	23.5 [597]	5 [127]	5.438 [138]	7.375 [187]
4EB	1510XF6M5S...	S	254T	16 [406]	42.5 [1080]	42.75 [1086]	14 [356]	14 [356]	32.25 [819]	16.125 [410]	0.875 [22]	6.688 [170]	26.167 [665]	23.75 [603]	5 [127]	5.531 [140]	7.25 [184]
5EB	1510XG6M5S...	L	254T	16 [406]	46.5 [1181]	46.75 [1187]	15 [381]	14 [356]	36.5 [927]	18.25 [464]	0.875 [22]	4.438 [113]	27.167 [690]	25.5 [648]	5 [127]	5.547 [141]	7.938 [202]
2GB	1510XC9M5S...	L	254T	16 [406]	46.5 [1181]	46.625 [1184]	14 [356]	14 [356]	36.5 [927]	18.25 [464]	0.875 [22]	3.875 [98]	26.167 [665]	23 [584]	5 [127]	5.5 [140]	7.25 [184]
3GB	1510XE9M5S...	L	254T	16 [406]	46.5 [1181]	46.375 [1178]	14 [356]	14 [356]	36.5 [927]	18.25 [464]	0.875 [22]	4.125 [105]	26.167 [665]	23.5 [597]	5 [127]	5.625 [143]	8 [203]
4GC	1510XF10M5S...	L	254T	16 [406]	46.5 [1181]	46.875 [1191]	15 [381]	14 [356]	36.5 [927]	18.25 [464]	0.875 [22]	4.625 [117]	27.167 [690]	25 [635]	5 [127]	6 [152]	8.563 [217]

e-1510X Series

e-1510X - DIMENSIONS AND WEIGHTS

(All dimensions in inches and weights in lbs. Do not use for construction purposes.)

Dimensions - Low speed (200-240V)

Pump Size	e-1510X PN	Frame	NEMA Frame	HA	HB	HC	HD	2HE	HF1	HF2	HH	HL	HM	HO	HP	Y	Z
1.25AD	1510XA1J5R...	S	143T	12 [305]	28.75 [730]	29.5 [749]	9.75 [248]	10.25 [260]	22.5 [572]	0 [0]	0.75 [19]	3.125 [79]	17.368 [441]	14.75 [375]	3 [76]	3.25 [83]	4.5 [114]
1.5AD	1510XB1J5R...	S	143T	12 [305]	28.75 [730]	29.375 [746]	9.75 [248]	10.25 [260]	22.5 [572]	0 [0]	0.75 [19]	11.688 [297]	17.368 [441]	15.75 [400]	3 [76]	3.125 [79]	4.625 [117]
1.25BC	1510XA4K5R...	L	213T	14.625 [371]	39.375 [1000]	39.875 [1013]	10.75 [273]	12.875 [327]	33.375 [848]	0 [0]	0.75 [19]	1.813 [46]	20.234 [514]	18.75 [476]	3 [76]	3.25 [83]	5.5 [140]
1.5BC	1510XB4L5R...	S	213T	14.625 [371]	34.625 [879]	36.875 [937]	10.75 [273]	12.875 [327]	28.625 [727]	0 [0]	0.75 [19]	1.688 [43]	20.234 [514]	17.25 [438]	3 [76]	3.109 [79]	5.75 [146]
2.5AC	1510XD2N5R...	S	213T	14.625 [371]	34.625 [879]	36.75 [933]	9.75 [248]	12.875 [327]	28.625 [727]	0 [0]	0.75 [19]	3 [76]	19.234 [489]	15.75 [400]	3 [76]	4.25 [108]	4.688 [119]
2AD	1510XC1J5R...	S	143T	12 [305]	28.34 [720]	29 [737]	9.75 [248]	10.25 [260]	22.5 [572]	0 [0]	0.75 [19]	3.563 [90]	17.368 [441]	16.25 [413]	3 [76]	3.5 [89]	4.75 [121]
2BD	1510XC5L5R...	S	213T	14.625 [371]	34.625 [879]	36.5 [927]	10.75 [273]	12.875 [327]	28.625 [727]	0 [0]	0.75 [19]	2.688 [68]	20.234 [514]	17.75 [451]	3 [76]	4 [102]	5.875 [149]
2.5BB	1510XD11R5R...	L	254T	16 [406]	46.5 [1181]	46.125 [1172]	12 [305]	14 [356]	36.5 [927]	18.25 [464]	0.875 [22]	3.875 [98]	24.167 [614]	18.75 [476]	5 [127]	4 [102]	6 [152]
3AD	1510XE1K5R...	L	215T	14.625 [371]	39.375 [1000]	42.625 [1083]	9.75 [248]	12.875 [327]	33.625 [854]	0 [0]	0.75 [19]	2.938 [75]	19.234 [489]	15.75 [400]	3 [76]	4.125 [105]	5 [127]
3BD	1510XE5M5R...	S	254T	14.625 [371]	39.375 [1000]	42.75 [1086]	10.75 [273]	12.875 [327]	33.375 [848]	0 [0]	0.75 [19]	3.688 [94]	22.917 [582]	18.25 [464]	3 [76]	4.75 [121]	6.125 [156]
4AD	1510XF1L5R...	L	213T	14.625 [371]	34.625 [879]	38.125 [968]	10.75 [273]	12.875 [327]	28.625 [727]	0 [0]	0.75 [19]	4.313 [110]	20.234 [514]	18.25 [464]	3 [76]	4.938 [125]	5.75 [146]
4BD	1510XF5M5R...	S	254T	14.625 [371]	39.375 [1000]	43 [1092]	12.75 [324]	12.875 [327]	33.375 [848]	0 [0]	0.75 [19]	4 [102]	24.917 [633]	20.75 [527]	3 [76]	5 [127]	7 [178]
5A	1510XG3R5R...	L	254T	16 [406]	46.5 [1181]	49.125 [1248]	14 [356]	14 [356]	36.5 [927]	18.25 [464]	0.875 [22]	6.875 [175]	26.167 [665]	22.5 [572]	5 [127]	5.813 [148]	6.25 [159]
5BD	1510XG5M5R...	S	254T	16 [406]	46.5 [1181]	44.375 [1127]	15 [381]	14 [356]	36.5 [927]	18.25 [464]	0.875 [22]	4.563 [116]	27.167 [690]	25 [635]	5 [127]	6 [152]	7.5 [191]
6BD	1510XH5M5R...	L	254T	16 [406]	46.5 [1181]	50.625 [1286]	15 [381]	14 [356]	36.5 [927]	18.25 [464]	0.875 [22]	8.375 [213]	27.167 [690]	25.5 [648]	5 [127]	7 [178]	8.25 [210]
2EB	1510XC6R5R...	S	254T	16 [406]	42.25 [1073]	42.5 [1080]	14 [356]	14 [356]	32.25 [819]	16.125 [410]	0.875 [22]	6.5 [165]	26.167 [665]	22 [559]	5 [127]	5.5 [140]	6.5 [165]
3EB	1510XE6M5R...	S	254T	16 [406]	42.25 [1073]	42.625 [1083]	14 [356]	14 [356]	32.25 [819]	16.125 [410]	0.875 [22]	6.688 [170]	26.167 [665]	23.5 [597]	5 [127]	5.438 [138]	7.375 [187]
4EB	1510XF6M5R...	S	254T	16 [406]	42.5 [1080]	42.75 [1086]	14 [356]	14 [356]	32.25 [819]	16.125 [410]	0.875 [22]	6.688 [170]	26.167 [665]	23.75 [603]	5 [127]	5.531 [140]	7.25 [184]
5EB	1510XG6M5R...	L	254T	16 [406]	46.5 [1181]	46.75 [1187]	15 [381]	14 [356]	36.5 [927]	18.25 [464]	0.875 [22]	4.438 [113]	27.167 [690]	25.5 [648]	5 [127]	5.547 [141]	7.938 [202]
2GB	1510XC9M5R...	L	254T	16 [406]	46.5 [1181]	46.625 [1184]	14 [356]	14 [356]	36.5 [927]	18.25 [464]	0.875 [22]	3.875 [98]	26.167 [665]	23 [584]	5 [127]	5.5 [140]	7.25 [184]
3GB	1510XE9M5R...	L	254T	16 [406]	46.5 [1181]	46.375 [1178]	14 [356]	14 [356]	36.5 [927]	18.25 [464]	0.875 [22]	4.125 [105]	26.167 [665]	23.5 [597]	5 [127]	5.625 [143]	8 [203]
4GC	1510XF10M5R...	L	254T	16 [406]	46.5 [1181]	46.875 [1191]	15 [381]	14 [356]	36.5 [927]	18.25 [464]	0.875 [22]	4.625 [117]	27.167 [690]	25 [635]	5 [127]	6 [152]	8.563 [217]

Flange Dimensions - All Models

Pump Size	Type	Discharge			Suction		
		Size	Thickness	O.D.	Size	Thickness	O.D.
1.25AD	NPT	1.25	-	-	1.5	-	-
1.5AD	NPT	1.5	-	-	2	-	-
1.25BC	NPT	1.25	-	-	1.5	-	-
1.5BC	NPT	1.25	-	-	1.5	-	-
2.5AC	ANSI 125#	2.5 [64]	0.6875 [17]	7 [178]	3 [76]	0.75 [19]	7.5 [191]
2AD	ANSI 125#	2 [51]	0.625 [16]	6 [152]	2.5 [64]	0.6875 [17]	7.125 [181]
2BD	ANSI 125#	2 [51]	0.875 [22]	6.25 [159]	2.5 [64]	1 [25]	7.375 [187]
2.5BB	ANSI 125#	2.5 [64]	0.6875 [17]	7 [178]	3 [76]	0.75 [19]	7.5 [191]
3AD	ANSI 125#	3 [76]	0.75 [19]	7.5 [191]	4 [102]	0.9375 [24]	9 [229]
3BD	ANSI 125#	3 [76]	0.75 [19]	7.5 [191]	4 [102]	0.9375 [24]	9 [229]
4AD	ANSI 125#	4 [102]	1.25 [32]	9.5 [241]	5 [127]	1.375 [35]	10.75 [273]

Pump Size	Type	Discharge			Suction		
		Size	Thickness	O.D.	Size	Thickness	O.D.
4BD	ANSI 125#	4 [102]	1.25 [32]	9.5 [241]	5 [127]	1.375 [35]	10.75 [273]
5A	ANSI 125#	5 [127]	1.375 [35]	10.75 [273]	6 [152]	1.4375 [37]	12.125 [308]
5BD	ANSI 125#	5 [127]	1.375 [35]	10.75 [273]	6 [152]	1.4375 [37]	12.125 [308]
6BD	ANSI 125#	6 [152]	1.4375 [37]	12.125 [308]	8 [203]	1.625 [41]	14.75 [375]
2EB	ANSI 125#	2 [51]	0.875 [22]	6.25 [159]	3 [76]	1.125 [29]	8 [203]
3EB	ANSI 125#	3 [76]	1.125 [29]	8 [203]	4 [102]	1.25 [32]	9.5 [241]
4EB	ANSI 125#	4 [102]	1.25 [32]	9.5 [241]	5 [127]	1.375 [35]	10.75 [273]
5EB	ANSI 125#	5 [127]	1.375 [35]	10.75 [273]	6 [152]	1.4375 [37]	12.125 [308]
2GB	ANSI 125#	2 [51]	0.875 [22]	6.25 [159]	3 [76]	1.125 [29]	8 [203]
3GB	ANSI 125#	3 [76]	1.125 [29]	8 [203]	4 [102]	1.25 [32]	10 [254]
4GC	ANSI 125#	4 [102]	1.25 [32]	10 [254]	5 [127]	1.375 [35]	10.75 [273]

Xylem |'zīləm|

- 1) The tissue in plants that brings water upward from the roots;
- 2) a leading global water technology company.

We're a global team unified in a common purpose: creating advanced technology solutions to the world's water challenges. Developing new technologies that will improve the way water is used, conserved, and re-used in the future is central to our work. Our products and services move, treat, analyze, monitor and return water to the environment, in public utility, industrial, residential and commercial building services settings. Xylem also provides a leading portfolio of smart metering, network technologies and advanced analytics solutions for water, electric and gas utilities. In more than 150 countries, we have strong, long-standing relationships with customers who know us for our powerful combination of leading product brands and applications expertise with a strong focus on developing comprehensive, sustainable solutions.

For more information on how Xylem can help you, go to www.xylem.com

Learn more about
e-1510X Smart Pumps



Xylem Product Cybersecurity:

Xylem values your system security and the availability of your critical services. For more information on Xylem cybersecurity practices or to contact the cybersecurity team please visit xylem.com/security.



Xylem Inc.
8200 N. Austin Avenue
Morton Grove, Illinois 60053
Phone: (847) 966-3700
Fax: (847) 965-8379
www.xylem.com/bellgossett

Xylem, Bell & Gossett and Hydrovar are registered trademarks of Xylem Inc. or one of its subsidiaries. MODBUS is a registered trademark of Schneider Electric USA, Inc. The Bluetooth word mark and logos are registered trademarks owned by Bluetooth SIG, Inc. and any use of such marks by Xylem Inc. or one of its subsidiaries is under license. All other trademarks or registered trademarks are the property of their respective owners.