



# Flygt Adaptive Mixers

ADVANCED SIMPLICITY



# Complete control and automation of the mixing process.

---

The only constant in wastewater treatment is change. Whether because of daily variation or long term population growth, the process demands in wastewater treatment shift constantly. With a traditional single-speed mixer, you have to operate at 100% capacity all the time, regardless of how much thrust your current process actually needs. Without the ability to control and adjust the speed of your mixer, you're wasting energy, time, and an opportunity to adapt to what happens next.

Because treatment processes are variable, your mixer should be too. With an integrated drive and advanced control capabilities, including full automation, you can have full control over your mixing or even let the mixer control itself. You can rely on Flygt Adaptive Mixers for highly efficient, streamlined, and optimized mixing in all conditions.





## SPEND LESS ON ENERGY

Flygt Adaptive Mixers can be controlled or automated to deliver only the thrust required – and nothing more – which results in remarkable energy cost savings.



## IMPROVE PROCESS RESILIENCY

**Sediment on your tank floor? Seasonal fluctuations? Process upgrades?** Flygt Adaptive Mixers let you adjust output, manually or automatically, to achieve the required mixing process result – no matter what.



## INCREASE MIXER UPTIME

With comprehensive monitoring, auto-correction functions, and a sealed, protected environment for the drive, Flygt Adaptive Mixers represent a new level in mixing reliability.



## REDUCE MIXER INVENTORY

Because the same adaptive mixer model can be used for different applications across your plant, your investment in spare parts and backup mixers can be reduced.

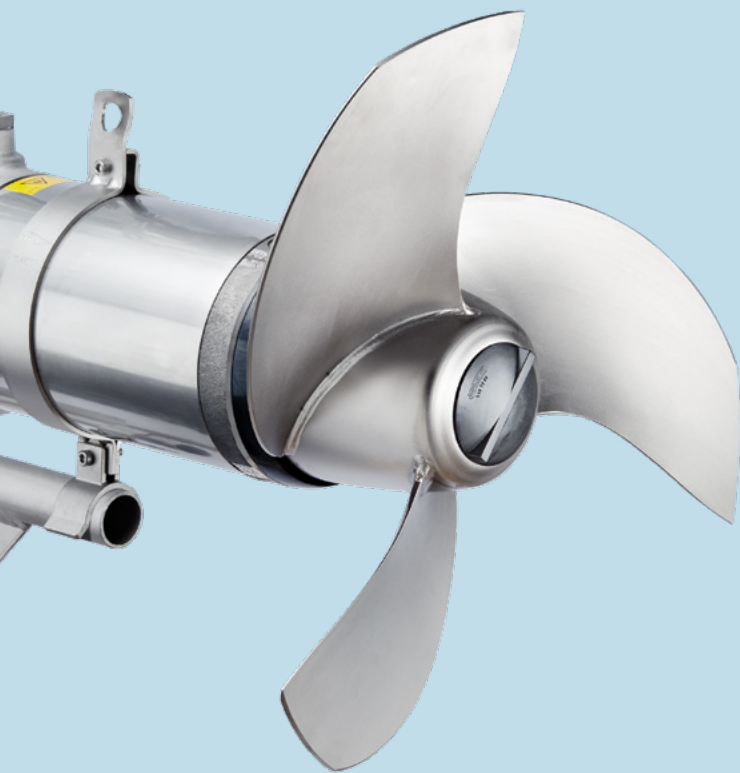

## + Outstanding efficiency with IE4 equivalent motor

Synchronous permanent magnet motors are super premium according to international standards. When compared to lower classifications such as IE3 – often based on conventional asynchronous technology – motors with IE4 efficiency use less energy.

## + Enhanced drive system reliability

The integrated control electronics of Flygt Adaptive Mixers are sealed inside a dust-free, non-oxidizing environment, reducing the risk for drive failure. Since the mixer is submerged in cooling media, no fan is needed, which otherwise is the most fail-prone component of a traditional VFD. This integrated design also eliminates potential errors from sizing, set-up, and wiring.

ADAPTIVE MIXERS

# Technical Innovations

Dirigo® is the intelligent, flexible, and submersible Flygt drive unit, which consists of a synchronous permanent magnet motor and an integrated motor control system. It enables advanced functionality, a more reliable system, and extended lifetime.

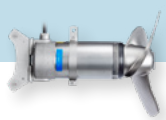

	Flygt 4220		Flygt 4230		Flygt 4320		
Rated power, 50/60 Hz	1.1–3.0 kW (1.5–4.0 hp)		2.2–7.3 kW (3.0–10.0 hp)		1.1–5.5 kW (1.5–7.5 hp)		
Propeller diameter	370 mm (15 in.)	580 mm (23 in.)	770 mm (30.3 in.)	1,400 mm (55 in.)	2,000 mm (79 in.)	2,500 mm (98 in.)	
Maximum thrust*, N	790	870	2,470	2,600	3,800	5,200	
Maximum efficiency*, N/kW	530	590	760	600	1,100	1,700	

\*According to ISO 21630:2007

## + Easy access to integrated control and monitoring functions

Operators can easily control and adjust the output via a tank-side control panel, PLC, or a plant-wide control system. Integrated monitoring functions include power consumption, energy meter, running time, drive temperature, phase loss alarm, and overload alerts.

## + Automated mixer control

Flygt Adaptive Mixers can be fully automated to adjust output to real airflow conditions, based on data from an airflow sensor or from a built-in feature that senses the airflow resistance in the tank. This system variant includes a controller that can also be used to operate multiple mixers.



## Scalable Mixer System

Whether you choose a standard, flexible or automated mixer system you can be assured of its unparalleled performance to meet your shifting process demands.



	AD	ADF	ADC
Mixer output	Fixed output	Manual control	Automated control
Automated mixer control			✓
Multiple mixer control			✓
IE4 motor efficiency	✓	✓	✓
High efficiency propeller	✓	✓	✓
Automatic overload protection	✓	✓	✓
Soft start	✓	✓	✓
Power factor close to 1	✓	✓	✓
Always correct propeller rotation	✓	✓	✓
Analog I/O and Modbus RTU/TCP		✓	✓
Full status and alarms information		✓	✓
Jog wheel operator panel, FOP 315 (optional)		✓	✓
Touch screen operator panel FOP 402 (optional)		✓	✓

### AD - STANDARD CONTROL

Standard system with pre-set control incorporates many built-in valuable features providing energy savings, key autonomous protection features, and scalability for ADF or ADC functionality at a later stage.

### ADF - FLEXIBLE CONTROL

Gear up your adaptive mixer for tank-side and remote operation by adding the Flygt FPG 415 gateway with analog input/output and fieldbuses. Easily connected operator panels or SCADA systems allow for fully integrated monitoring functions, so you can be assured of optimal mixer operation wherever you may be.

### ADC - AUTOMATED CONTROL

Automated control and multiple mixer operation for aerated processes by adding the Flygt APP 412 pre-engineered controller. Available speed control functions:

- Setpoint control: Mixer speed based on whether the aeration system is on or off.
- Airflow meter control: Mixer speed adapted to data from an airflow meter.
- Oxidation ditch control: Mixer speed control based on internal sensing of the aeration system's output. Patented method measuring airflow via propeller torque. No external airflow meter needed.



# Spend Less On Energy

Designed to deliver the exact output you need.

## + Match output to demand

Unlike single-speed mixers, which operate at a fixed duty point and use the same amount of energy regardless of process demands, Flygt Adaptive Mixers only use the energy you need based on an exact set of process demands.

## + Avoid overdimensioning

Thanks to their variable speed, Flygt Adaptive Mixers can be easily adjusted during commissioning, overcoming uncertainties from the design phase that often lead to over-dimensioning. Plants operating below their long-term design capacity benefit from this flexibility as well.

## + Market-leading ISO 21630 efficiency

With efficiencies of up to 1,700 newtons of thrust per kilowatt of input electrical power, Flygt Adaptive Mixers can reduce power consumption by up to 50%, resulting in significant cost savings compared to a conventional single-speed mixer.

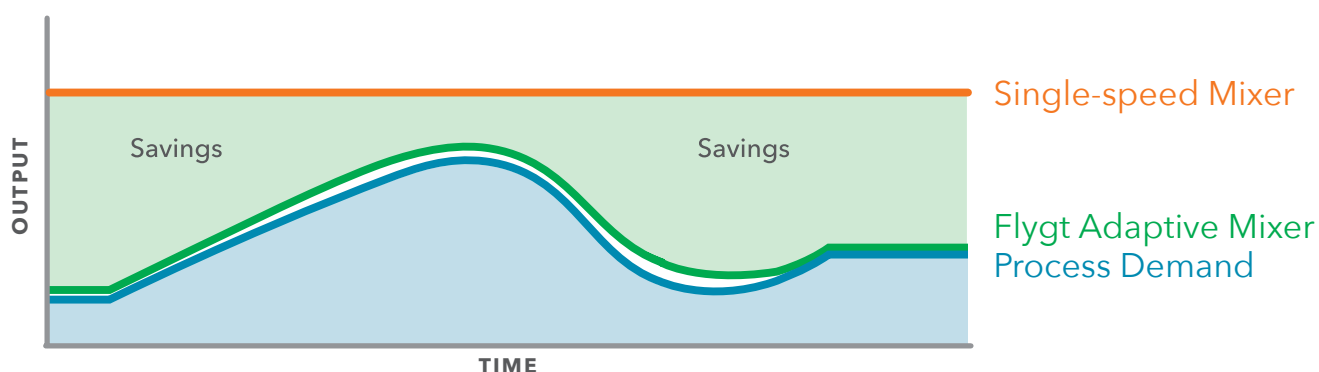

# Proven Savings in the Field

YPSILANTI, MICHIGAN, USA

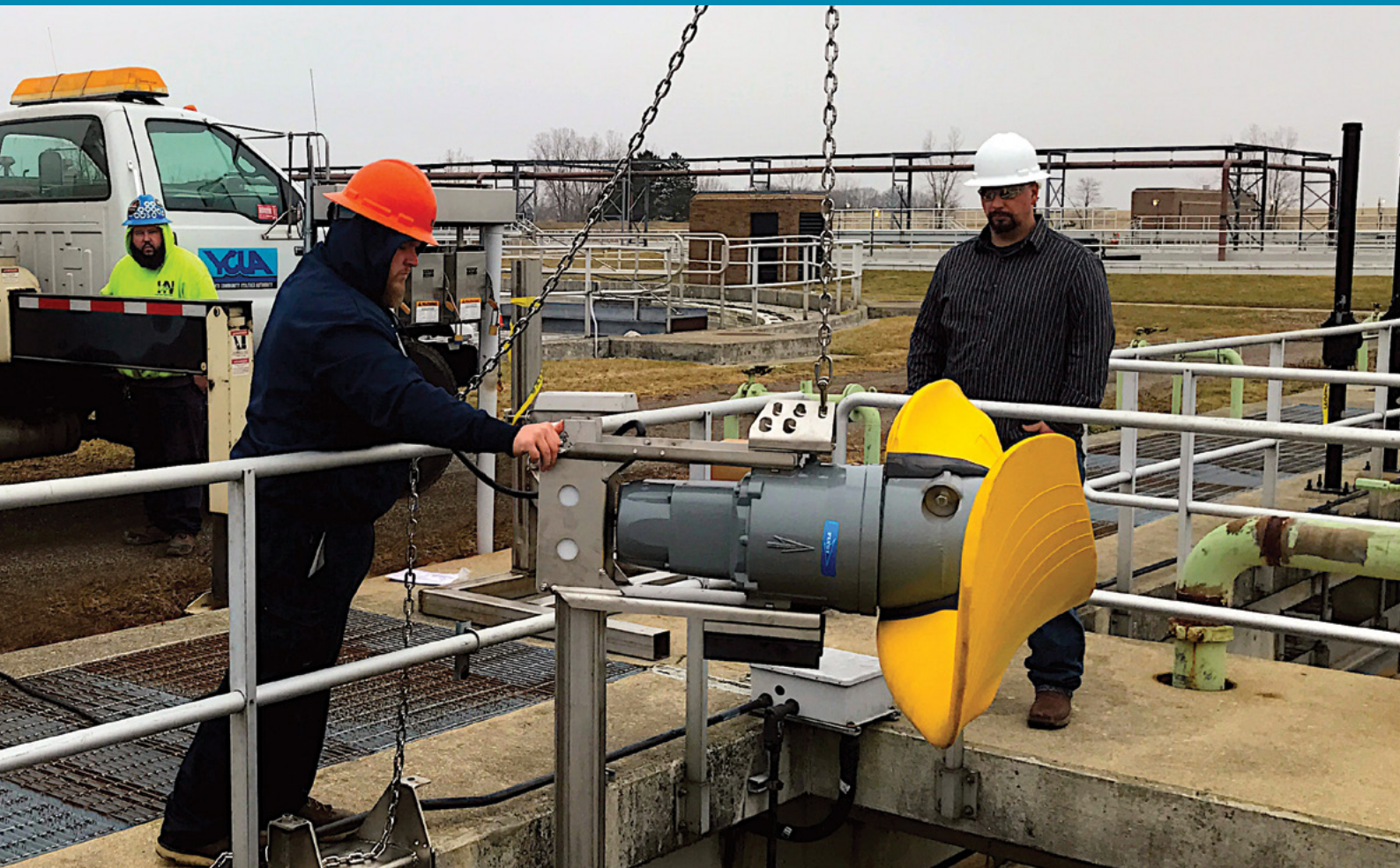

## Flygt 4320

APPLICATION:

Anoxic tank in a biological treatment process

COSTS SAVINGS:

**A 92% decrease in energy consumption**

## Energy Comparison

Adaptive speed vs single-speed mixers

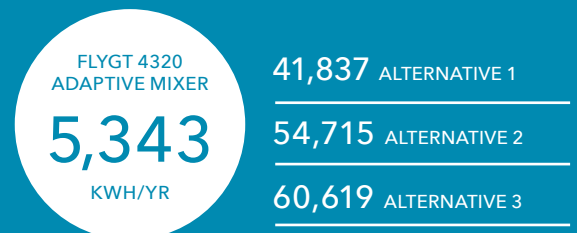

# Improve Process Resiliency

Flygt Adaptive Mixers let you handle both the expected and the unknown.



## + Instant adjustment at your fingertips

For infrequent events like seasonal fluctuations, tank cleanings, or plant upgrades, the user-friendly operator panel, or the connected control room, puts you in complete control to adapt your mixer's output quickly and efficiently.

## + Process flexibility with automated mixer control

Configuring your mixer for full automation allows for continuous and exact regulation of mixer output to optimize process results, also generating additional energy savings.

Different functions are available to enable this automatic output regulation. One of them, for oxidation ditch control, uses a unique, built-in capability to measure real-time airflow resistance in the tank and adjust output automatically and continuously to match actual demand.



# Handling Process Changes

ADAPTING MIXER OUTPUT GENERATES SIGNIFICANT ENERGY SAVINGS

MIXER OUTPUT

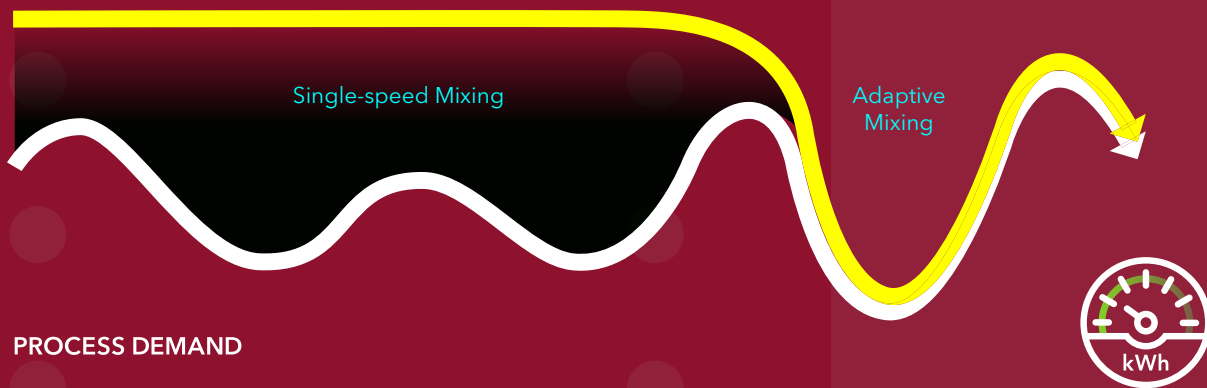

Typical applications with common process changes

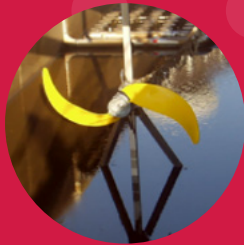

**Oxidation Ditches**  
Varying airflow

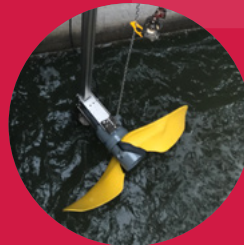

**Anoxic Zones**  
Varying inflow



**Sequence Batch Reactors**  
Varying wastewater level

Solving process issues

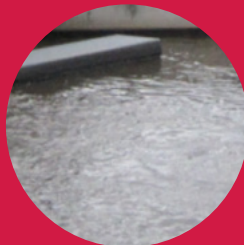

**Problem:** Strong current everywhere with too much mixing

**Solution:** Decrease output with an Adaptive Mixer

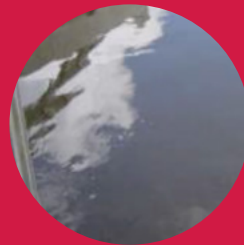

**Problem:** Clear layers with too little mixing

**Solution:** Increase output with an Adaptive Mixer



**Problem:** Sludge deposits with too little mixing

**Solution:** Increase output with an Adaptive Mixer

# Increase Mixer Uptime

Proven non-stop performance makes your job easier.

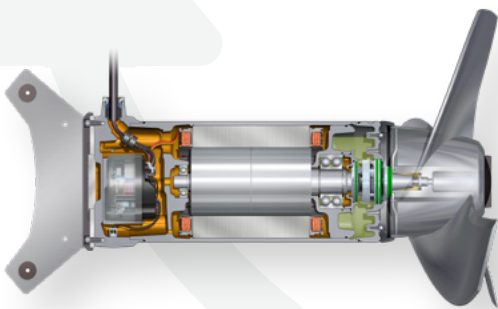

## + Enhanced drive system reliability

Placing the control electronics inside a dust-free, non-oxidizing environment reduces the risk for drive failure. In addition, the mixer's integrated components are submerged in a cooling media, which eliminates the need for a fan – the most fail-prone component of a traditional VFD (variable frequency drive). This integrated design also eliminates potential errors from sizing, setup, and wiring.

## + Integrated monitoring

With a Flygt Adaptive Mixer, you know exactly what is going on without having to touch the mixer – or even leave your control room. Integrated monitoring functions include power consumption, energy meter, running time, drive temperature, phase loss alarm, and overload alerts.

## + Adjusts for overload conditions

When overload conditions are imminent, a Flygt Adaptive Mixer automatically senses the danger, adjusts output accordingly, and triggers an alarm.

## + Easy replacement of existing mixers

Flygt Adaptive Mixers can often be installed without changing the existing installation system because they fit most common guide bar dimensions.

## + Low maintenance costs

From the reduced wear of the mixers themselves – thanks to their variable output – to their advanced motors, ActiveSeal™ technology, and durable hydraulics, Flygt Adaptive Mixers were designed to handle the harsh demands of wastewater treatment with long maintenance intervals.

# Reduce Mixer Inventory



[ Lower investment. Flexibility for the future. ]

## + Smaller inventory of mixers and parts

Because Flygt Adaptive Mixers cover a range of duty points, plants can deploy them across different tanks and applications, which requires a smaller capital investment in spare parts and backup mixers.

## + Lower investment upon reuse

With their easy adjustment, Flygt Adaptive Mixers can be reused in other tanks and applications. During a process redesign or upgrade, Flygt Adaptive Mixers can even be exchanged among different plants – avoiding the need to rebuild or replace an existing mixer.

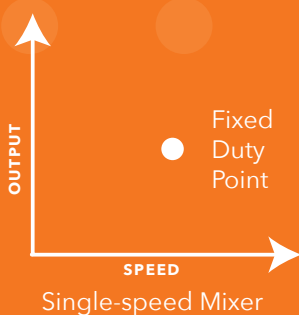

A single-speed mixer has a fixed output that does not allow for change, even if the process demand were to increase or decrease.

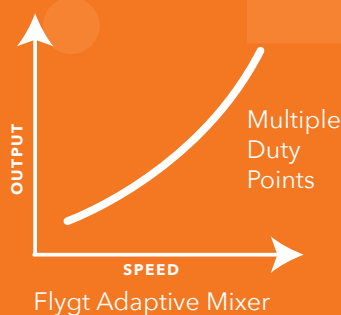

A Flygt Adaptive Mixer has an output range for the utmost in flexibility in response to process changes.

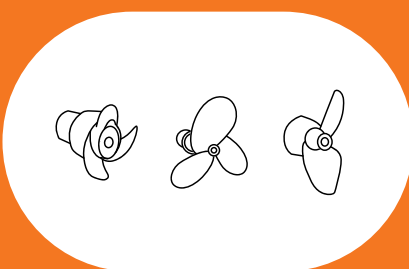

**Conventional:** One fixed output per mixer. Various brands and models over time.



**Flygt Adaptive Mixer:** One single model with wide output range.



# Xylem |'zīləm|

- 1) The tissue in plants that brings water upward from the roots;
- 2) a leading global water technology company.

We're a global team unified in a common purpose: creating advanced technology solutions to the world's water challenges. Developing new technologies that will improve the way water is used, conserved, and re-used in the future is central to our work. Our products and services move, treat, analyze, monitor and return water to the environment, in public utility, industrial, residential and commercial building services settings. Xylem also provides a leading portfolio of smart metering, network technologies and advanced analytics solutions for water, electric and gas utilities. In more than 150 countries, we have strong, long-standing relationships with customers who know us for our powerful combination of leading product brands and applications expertise with a strong focus on developing comprehensive, sustainable solutions.

**For more information on how Xylem can help you, go to [www.xylem.com/adaptivemixers](http://www.xylem.com/adaptivemixers)**