



e-HMX

THE MANUAL IS AVAILABLE AT:
<https://qr.xylemsales.com/ocmx80>



For safety and correct product usage, read the manual before this product is used.

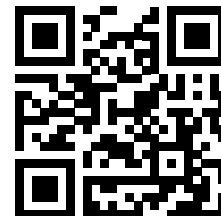

1 Introduction

NOTICE:



Read the installation, operation and maintenance instructions located on the Xylem website before use. Improper use of the product can cause personal injury and damage to property and may void the warranty. See the e-HM, hydrovar X Smart Pump, and hydrovar X Instruction Manuals for complete product warranty and installation instructions.



WARNING:

Always lock out power to the driver before you perform any installation of maintenance tasks. Failure to disconnect and lock out driver power will result in serious injury.



WARNING:

This product can expose you to chemicals including Lead, which is known to the State of California to cause cancer and birth defects or other reproductive harm. For more information go to: www.P65Warnings.ca.gov.



WARNING:

Personal protective equipment should be worn when handling this equipment. Only use properly sized certified lifting equipment & lifting devices, including slings, suitably rated for the weights to be lifted. Slings, when used, must be of identical materials to avoid differences in stretch rates. Do not use lifting devices that are frayed, kinked, unmarked, or worn.

2 Lifting and handling requirements



WARNING:

- Assembled units and their components are heavy. Failure to properly lift and support this equipment can result in serious physical injury and/or equipment damage. Lift equipment only at the specifically identified lifting points. Lifting devices such as eyebolts, slings, and spreaders must be rated, selected, and used for the entire load being lifted.
- Crush hazard. The unit and the components can be heavy. Use proper lifting methods and wear steel-toed shoes at all times.

 For safety and correct product usage, read the manual before this product is used.

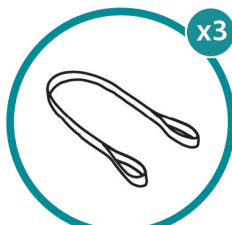
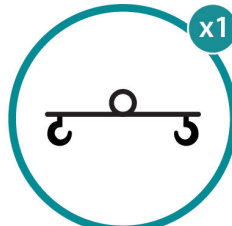
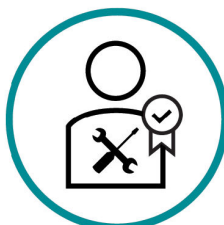
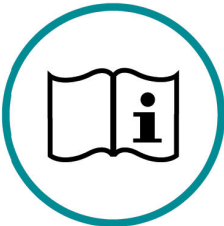

Torx



COND		By a COMPANY	
Model:			
Cl.	IR	VA	SA
Temp. °C			
COND. %			
h			



% <50% @ 40°C (104°F)



COND		By a COMPANY	
Model:			
Cl.	IR	VA	SA
Temp. °C			
COND. %			
h			



1 



i

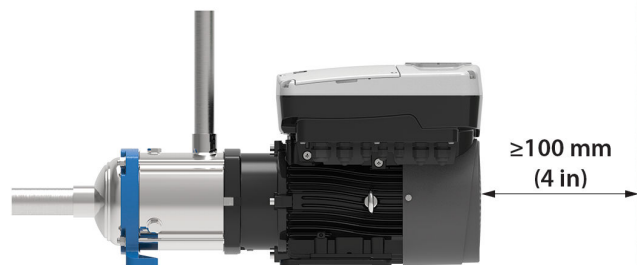
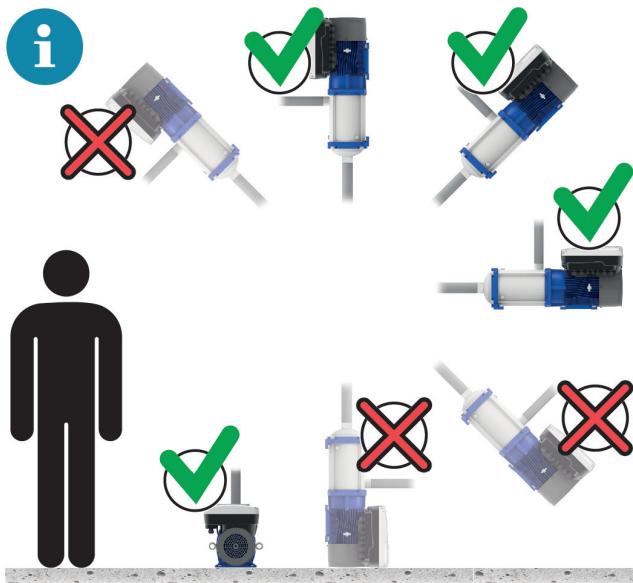

2

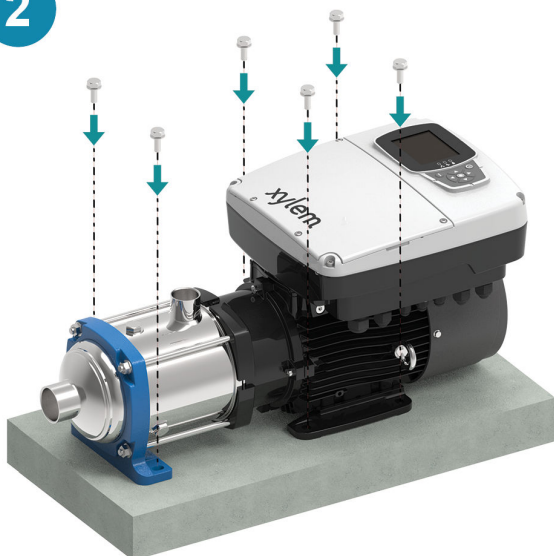

3

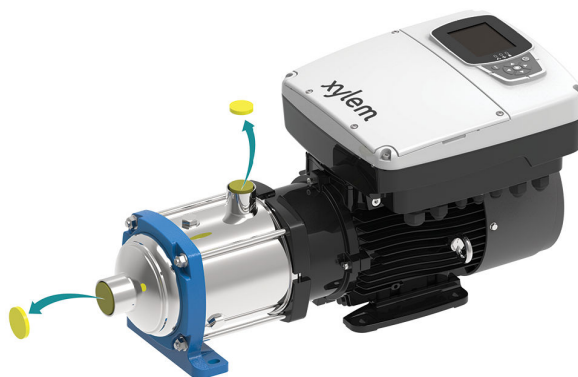

4

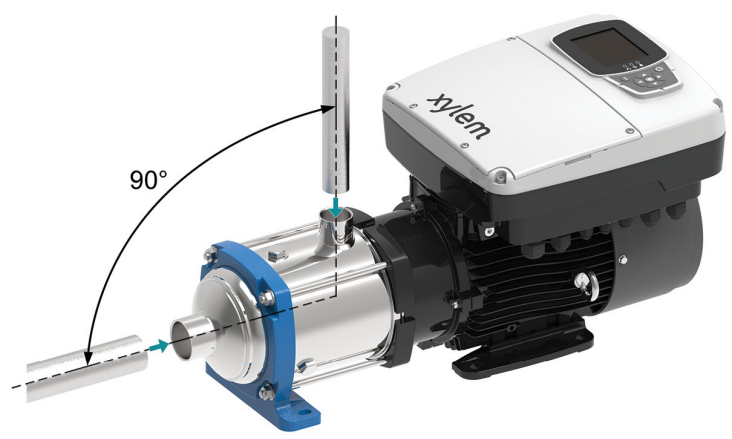

i

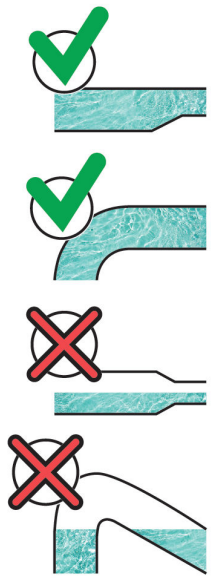

5

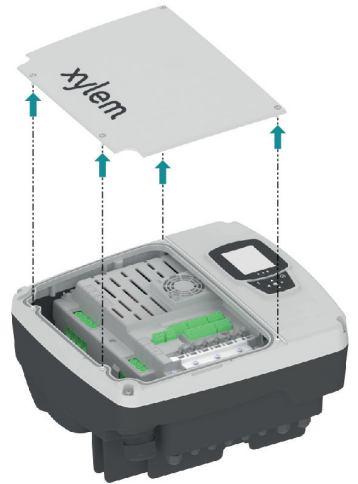

6

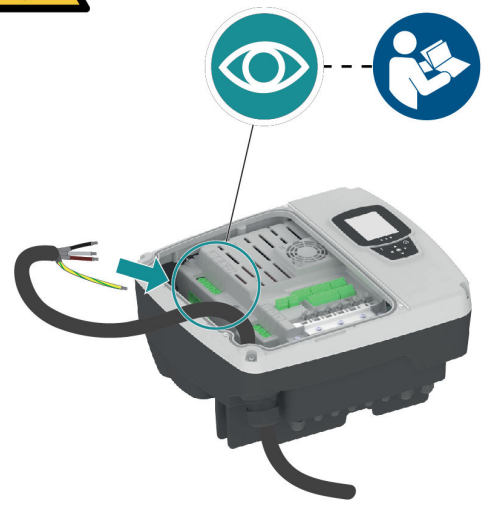

7



8



 3 Nm
±15%

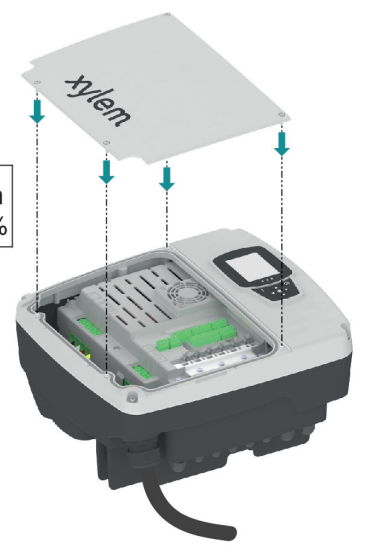

9

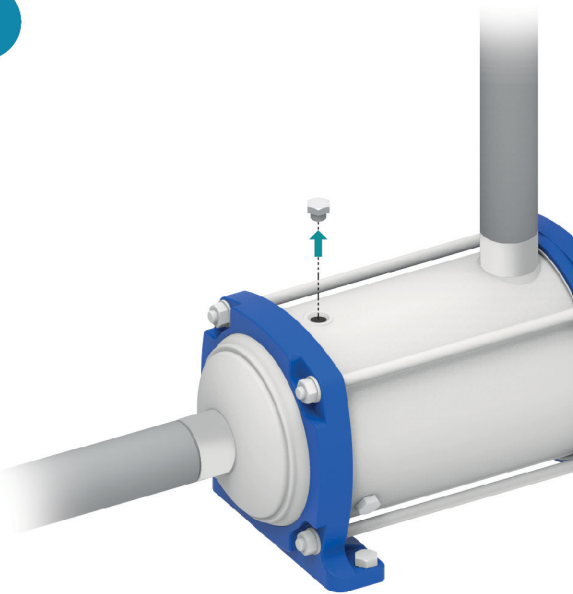

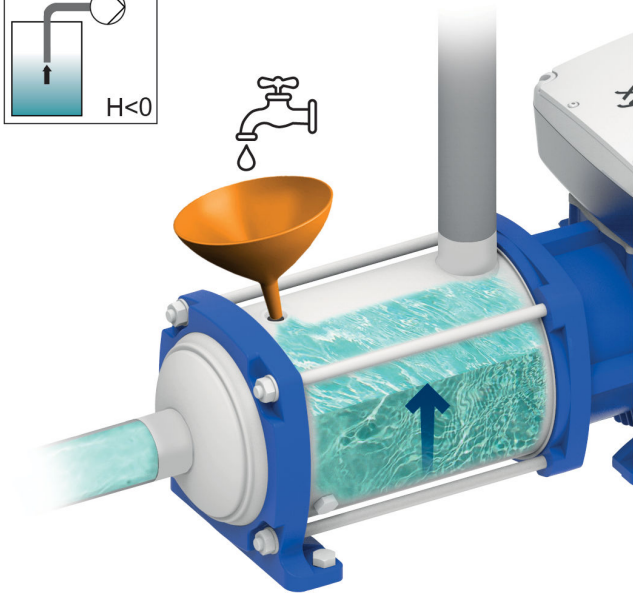
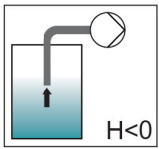
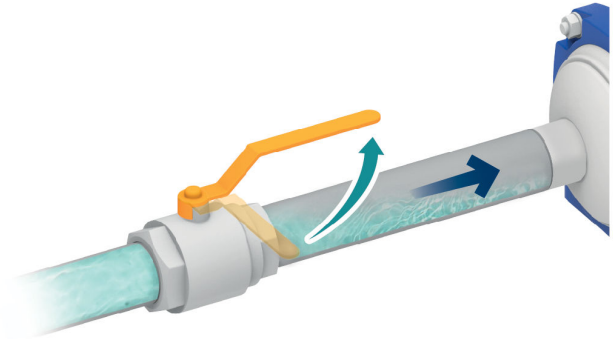
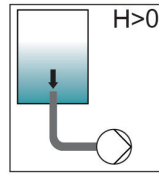

10

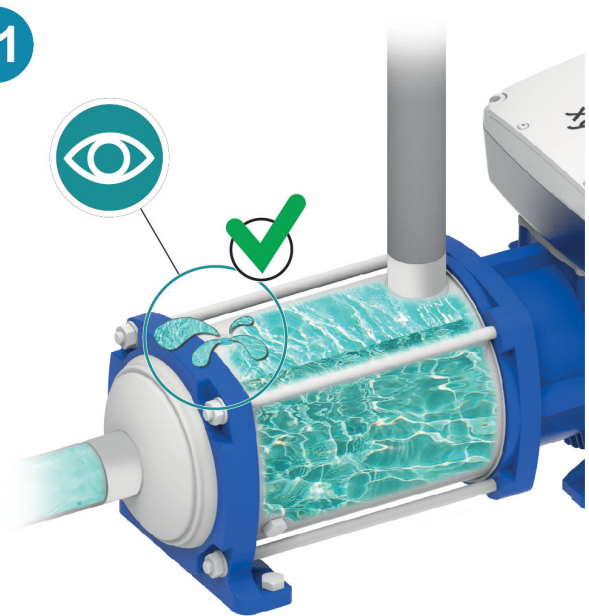

11



12

	
$G\ 1/4''$	$8 \pm 25\%$ Nm

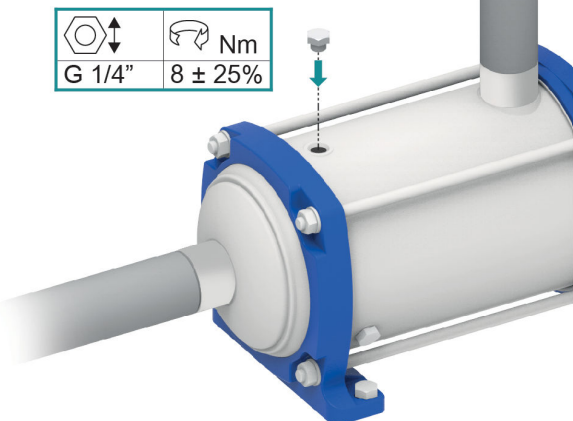

13

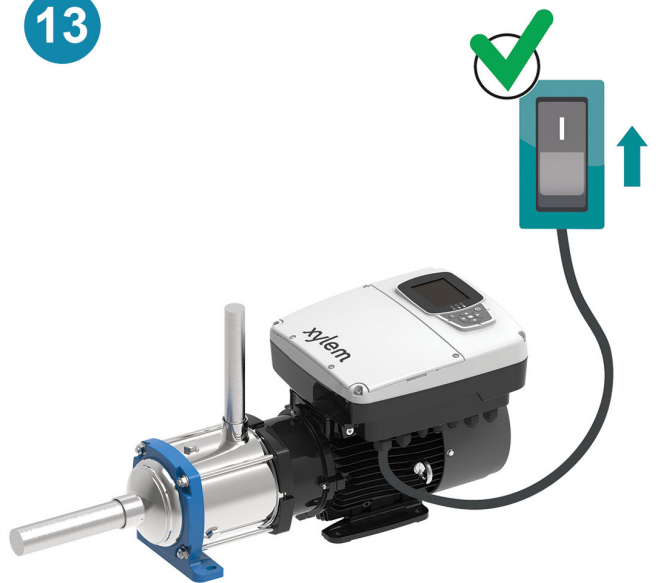

3 Electrical installation

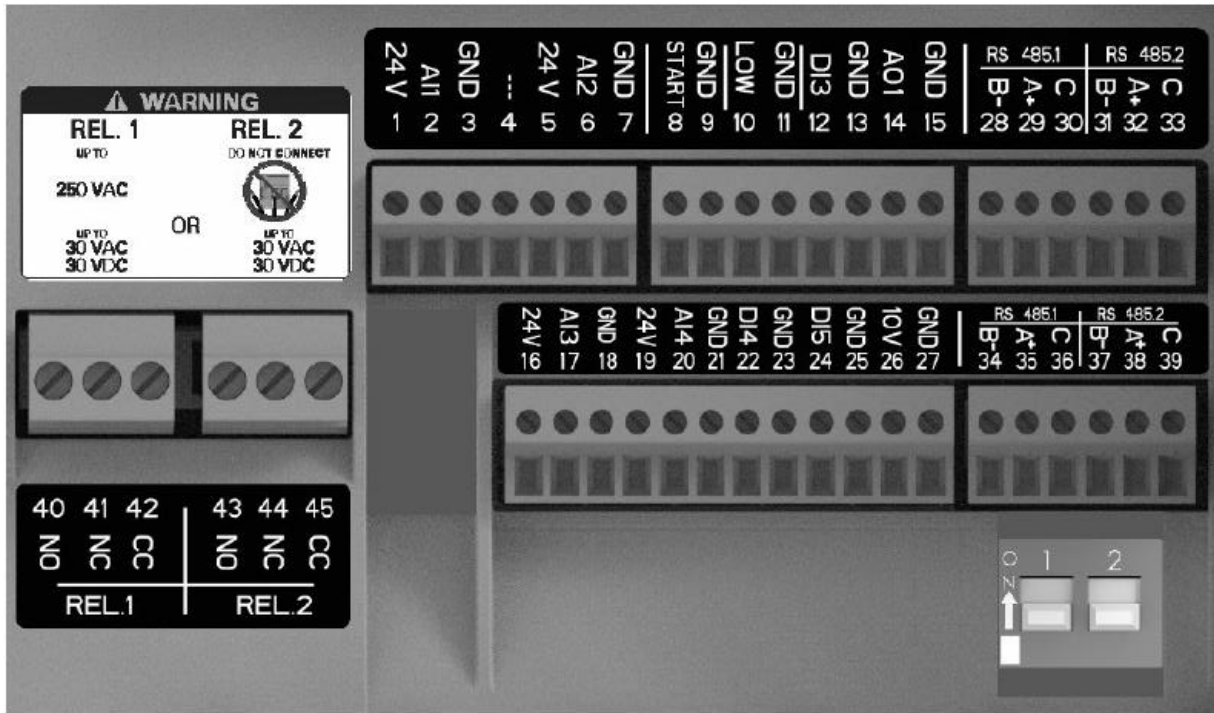

Figure 1: Auxiliary connections

Table 1:

Position number	Name	Description	Default setting
1	Analog input 1	Power supply +24 VDC, max. 60 mA (total, terminals 1 + 5)	Pressure sensor 1
2		Configurable analog input 1	
3		Electronic GND	
4	Reserved	For internal use, do not connect	-
5	Analog input 2	Power supply +24 VDC, max. 60 mA (total, terminals 1 + 5)	Not selected
6		Configurable analog input 2	
7		Electronic GND	
8	External Start/Stop	Digital start/stop input, internal pull-up +24 VDC, contact current 6 mA	-
9		Electronic GND	
10	External lack of water	Low water level digital input, internal pull-up +24 VDC, contact current 6 mA	-
11		Electronic GND	
12	Digital input 3	Configurable digital input 3, internal pull-up + 24 VDC, contact current 6 mA	Emergency start at maximum speed
13		Electronic GND	
14	Analog output	Configurable output	Motor Speed
15		Electronic GND	-
16	Analog input 3	Power supply +24 VDC, max. 60 mA (total, terminals 16 and 19)	Not selected
17		Configurable analog input 3	
18		Electronic GND	
19	Analog input 4	Power supply +24 VDC, max. 60 mA (total, terminals 16 and 19)	Not selected
20		Configurable analog input 4	
21		Electronic GND	



For safety and correct product usage, read the manual before this product is used.

Position number	Name	Description	Default setting
22	Digital Input 4	Configurable digital input 4, internal pull-up +24 VDC, contact current 6 mA	Not selected
23		Electronic GND	
24	Digital Input 5	Configurable digital input 4, internal pull-up +24 VDC, contact current 6 mA	Not selected
25		Electronic GND	
26	10 VDC power supply	Power supply +10 VDC, max. 3 mA	-
27		Electronic GND	
28	Communication Bus 1	RS485 port 1: RS485-1B N(-)	Multipump
29		RS485 port 1: RS485-1A P(+)	
30		RS485 port 1: RS485-COM	
31	Communication Bus 2	RS485 port 2: RS485-2B N(-)	Modbus
32		RS485 port 2: RS485-2A P(+)	
33		RS485 port 2: RS485-COM	
34	Communication Bus 1	RS485 port 1: RS485-1B N(-)	Multipump
35		RS485 port 1: RS485-1A P(+)	
36		RS485 port 1: RS485-COM	
37	Communication Bus 2	RS485 port 2: RS485-2B N(-)	Modbus
38		RS485 port 2: RS485-2A P(+)	
39		RS485 port 2: RS485-COM	
40	Relay 1	Configurable relay 1: normally open	Error reporting
41		Configurable relay 1: normally closed	
42		Configurable relay 1: common contact	
43	Relay 2	Configurable relay 2: normally open	Motor start
44		Configurable relay 2: normally closed	
45		Configurable relay 2: common contact	

4 Drive operation

Table 2:

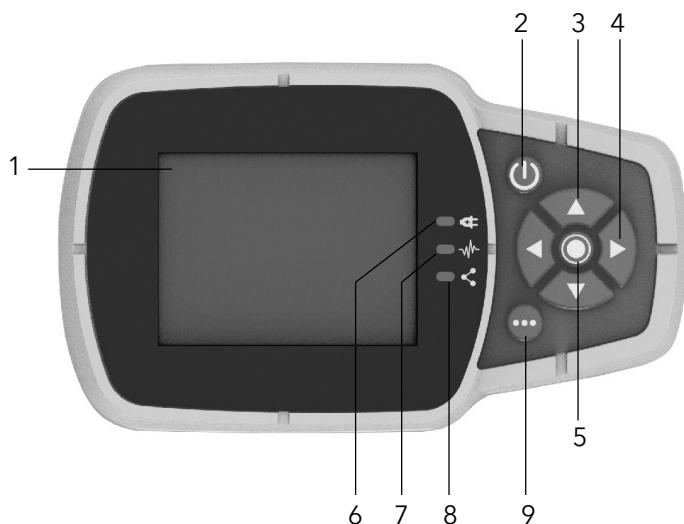

NOTICE:

For first-time start-up and programming, the unit is equipped with a start-up genie to select the appropriate operating mode and other parameters for the intended application.

Figure 2: Interface screen

Table 3:

Position number	Name	Function
1	Display	
2	ON/OFF button	<ul style="list-style-type: none"> Start and stop the unit Reset the errors by pressing for 5 seconds.



For safety and correct product usage, read the manual before this product is used.

Position number	Name	Function
3	UP and DOWN arrow keys	<ul style="list-style-type: none"> Move vertically between menu options Perform a manual switch-over on a multi-pump system by pressing the DOWN arrow (extended pressure) Rotate the display 180° by simultaneously pressing ENTER and the UP arrow (extended pressure).
4	RIGHT and LEFT arrow keys	<ul style="list-style-type: none"> Move horizontally to navigate home screens and menus Lock and unlock the display by simultaneously pressing the RIGHT and LEFT arrows (extended pressure).
5	SEND button	<ul style="list-style-type: none"> Advancing through the menu levels Confirm the selection of a parameter Confirm the value of a parameter.
6	Unit LED on	Indicate that the unit is powered.
7	Unit status LED	Indicate: <ul style="list-style-type: none"> Motor no powered (off) Alarm active and motor stopped (yellow) Unit error and motor stopped (red) Motor started (green) Alarm active and motor started (yellow alternating green).
8	Connection status LED	Indicate <ul style="list-style-type: none"> BMS communication disabled (off) BMS communication active (green) Wireless communication with mobile device established (fixed blue) Wireless communication with mobile device being established (flashing blue) Wireless communication and BMS communication active (blue alternating green).
9	Multifunction button	<ul style="list-style-type: none"> Access the parameter menu or additional functions according to the screen on the display. Enable the unit to a mobile device (extended pressure)

5 Xylem App setup

Introduction

Available for mobile devices with wireless technology operating system.

Use the App to:

- Check the status of the unit
- Configure parameters
- Interact with the unit and obtain data during installation and maintenance
- Generate a work report
- Contact the assistance service.

Download the App and connect the mobile device with the unit

1. Download the Xylem X App to the mobile device from App Store¹ or Google Play² by scanning the QR code:



2. Complete the registration.
3. On the drive display, press the wireless communication button.
4. Add the unit to the user profile.
5. When the connection has been established, the connection light turns steady blue. It is now possible to control the unit using the mobile device.

¹ Compatible with iOS® operating systems with version 15.0 and above.

² Compatible with Android operating system with version 10.0 and above.

 For safety and correct product usage, read the manual before this product is used.

Xylem product cybersecurity

Xylem values system security and resilience. Defending against cybersecurity threats is a shared responsibility. Xylem builds products that are secure by de-

sign. Our customers have a responsibility to understand the risks inherent in their processes and take steps to operate and maintain their solutions securely. For details and updates on Xylem product cybersecurity visit xylem.com/security





For safety and correct product usage, read the manual before this product is used.

Xylem Inc.
1 Goulds Drive, Auburn, NY13021, USA
Tel: +1 (866) 325-4210, Fax: +1 (800) 322-5877
www.xylem.com/goulds

Xylem is a registered trademark of or one of its subsidiaries. Goulds is a registered trademark of ITT Manufacturing Enterprises LLC and is used under license. All other trademarks or registered trademarks are property of their respective owners.

© 2024 Xylem Inc.

IM425_Rev B_en-US_2024-01_QG_e-HMX