



e-SVX Series Smart Pumps

Integrated pump, motor & variable speed
drive solutions, **powered by hydrovar® X**

Xylem Solver

Xylem Solver is a pump selection software with multiple search options and helpful product information.

Solver can be available: at <https://solver.xylem.com/>

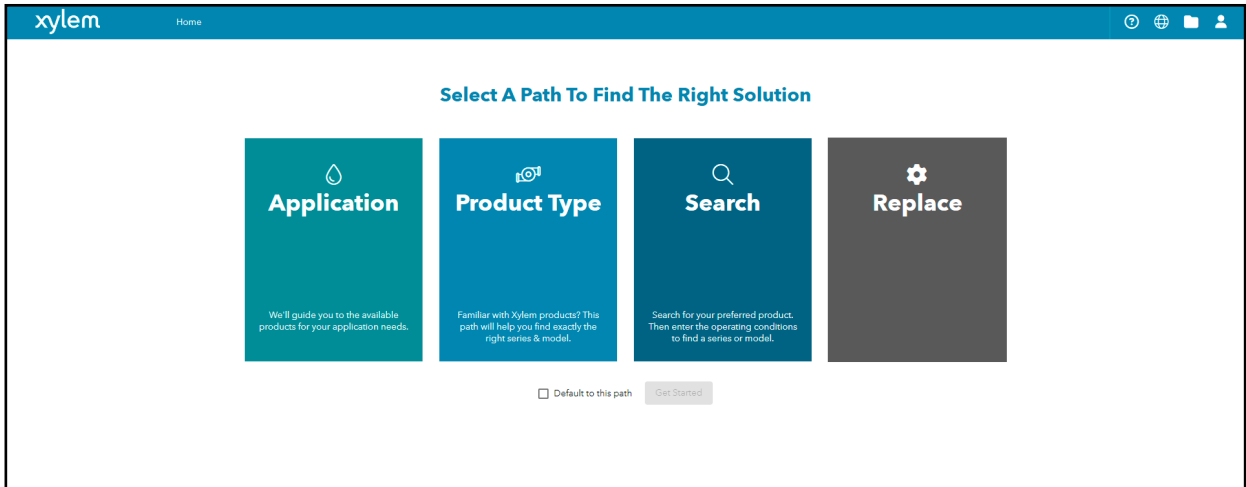

Contents

e-SVX Series Vertical Multistage Pump with hydrovar® X	4
hydrovar X	5
e-SVX Nameplate	6
e-SVX Series Hydraulic Coverage Curves	6
Nomenclature	7-8
e-SVX Model Summary	9-11
e-SV with hydrovar X.	12
Terminal Block	13
How to Read Smart Pump Series Curves.	14
Electrical Data Tables	15-17
1, 3, 5 SVX Series - Three Phase Version Dimensions and Weights	18-28
10 SVX Series - Three Phase Version Dimensions and Weights	29-36
15 SVX Series - Three Phase Version Dimensions and Weights	37-45
22 SVX Series - Three Phase Version Dimensions and Weights	46-53
33 SVX Series - Three Phase Version Dimensions and Weights	54-61
46 SVX Series - Three Phase Version Dimensions and Weights	62-68
66 SVX Series - Three Phase Version Dimensions and Weights	69-74
92 SVX Series - Three Phase Version Dimensions and Weights	75-79
125 SVX Series - Three Phase Version Dimensions and Weights	80-82
NPSH.	83
Technical Data - Water Property Chart.	84
Volumetric Capacity, Pressure Head, Length, Volume.	85
Technical Data - Compatibility Chart for Materials	86

e-SVX SERIES VERTICAL MULTISTAGE PUMP WITH HYDROVAR® X

Background and context

In every sector, from construction and industry to agriculture and building services the need for intelligent, compact and high-efficiency pumping systems is constantly growing.

That's why Goulds Water Technology has developed the e-SVX Series: an integrated intelligent pumping system with electronically driven, ultra-premium IE5, permanent magnet assisted synchronous reluctance motor.

The integrated control system, combined with the high performance, power and efficiency from the motor and hydraulics, guarantees impressively low operating costs. You also benefit from flexibility, precision and its ultra-compact size.

Savings

The electronics and permanent magnet motor are highly efficient and minimize power losses while transferring maximum energy to the hydraulic parts of the pump.

The refined control system with integrated microprocessor adjusts the motor speed, matching the required operating point of the pump or system requirements.

This reduces demand on electricity according to the required working conditions.

This creates economies, especially in systems where pump demand varies over time.

Flexibility

The compact size, low loss and increased control make the e-SVX series a good choice in applications and systems where fixed speed pumps are commonly used. The e-SVX series is easy to integrate in control and regulation loops thanks to the wide availability of compatible communication protocols, including analog and digital inputs.

The pump is supplied with a pressure sensor.

Ease of use and commissioning

e-SVX has an intuitive interface that guides the user through the installation, and a practical area to assist with connections.

The control system is integrated and no additional external electrical panel is required.

Application sectors

- Water supply systems in residential buildings
- Air conditioning/HVAC
- Water treatment plants
- Industrial installations
- Light commercial
- Agriculture
- OEM

e-SVX Series Pump (e-SV pump with hydrovar X Smart Motor)

- Delivery: Up to 600 gpm (136 m³/hr)
- Head: Up to 1155 feet (352 m)
- Liquid temperature: -20°F to 250°F (-30°C to 120°C) standard version
- Optional temperature range up to 300°F (149°C) high temperature version (sizes 1 -22SV)
- Maximum operating pressure
 - 1-22SV with oval flanges: 230 psi (16 bar)
 - 1-22SV with round flanges or Victaulic: 362 or 575 psi (25 or 40 bar)
 - 33SV, 46SV: 362 or 580 psi (25 or 40 bar)*
 - 66SV, 92SV: 362 or 580 psi (25 or 40 bar)*
 - 125SV: 362 or 580 psi (25 or 40 bar)
- Direction of rotation: clockwise looking at the pump from the top down (marked with an arrow on the adapter and on the coupling).

The e-SVX pump is a non-self priming vertical multistage pump. The liquid end, located between the upper cover and the pump casing, is held in place by tie rods. The pump casing is available with different configurations and connection types.

*Based on pump staging

hydrovar X Smart Motor

- IES2 Power drive system (PDS) efficiency (IEC 61800-9-2:2017)
- IE5 Motor efficiency (IEC TS 60034-30-2:2016)
- NEMA 4
- Insulation class 115 (Class F)
- Totally enclosed fan cooled (TEFC) construction
- 3-Phase power supply
- Rated speeds (low speed models): 1500, 1800, and 2000 RPM¹
- Rated speeds (high speed models): 3000 and 3600 RPM¹
- Low speed models: 1.5 kW to 11 kW (2 HP to 15HP): 200-240V and 380-480V +/- 10%, 50/60Hz
- High speed models: 3 kW to 22 kW (4 HP to 30 HP): 380-480V +/- 10%, 50/60Hz
- RS485 Communication interface, BACnet and MODBUS® standard and BLE included
- Overload and locked rotor protection with automatic reset included
- Multi-pump linking (up to 8 pumps)

Learn more about
hydrovar X



¹ Rated speeds are used to determine the net efficiency of a pump-drive system and for energy efficiency listings. Pumps may or may not utilize the full speed range of hydrovar X depending on a variety of factors or limitations.

² A select number of high speed models are available for 200-240V applications. Refer to the hydrovar X technical documentation for more information.

e-SVX Nameplate

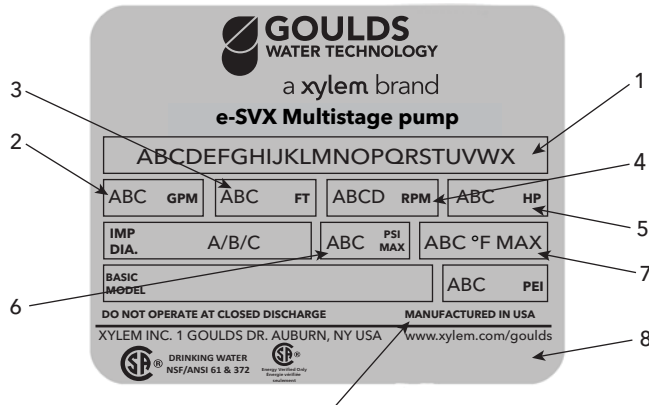

No.	Description
1	Goulds Catalog Number
2	Capacity Range
3	TDH Range
4	Rated Speed
5	Rated Horsepower
6	Maximum Operating Pressure
7	Maximum Operation Temperature
8	Pump Serial Number

e-SVX Series Hydraulic Coverage Curves

METERS FEET

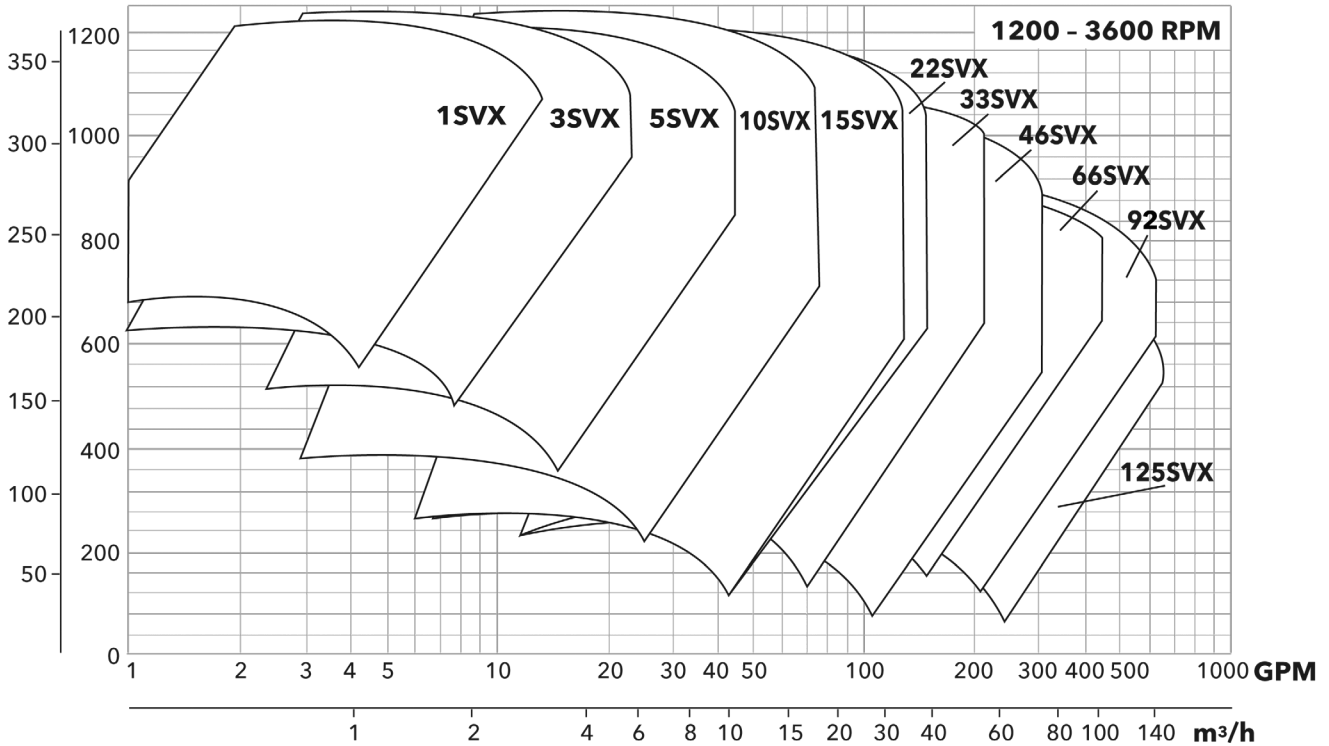

Example Product Code (1-22 e-SVX)*

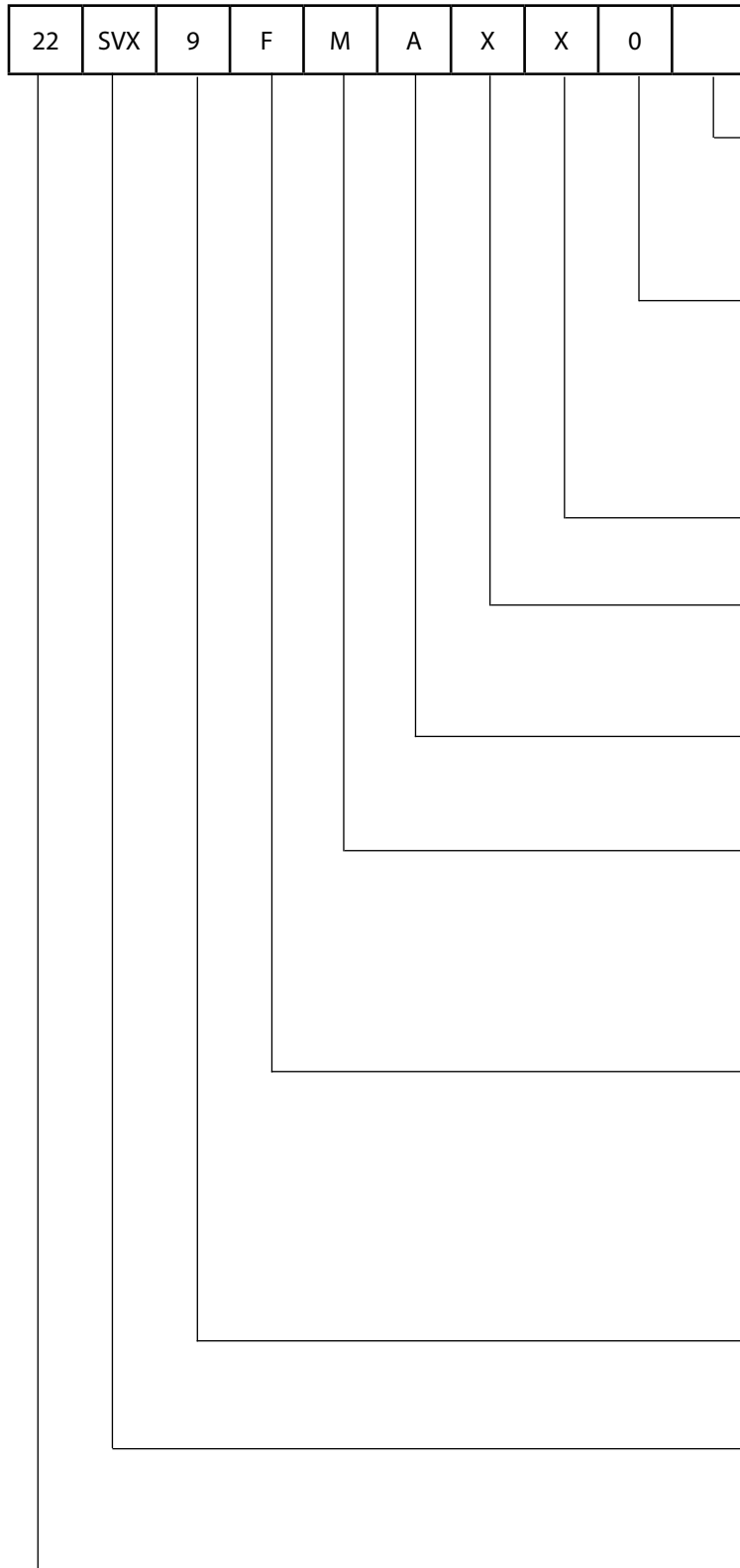

Each e-SVX pump is identified by a product code on the pump label. Each digit in the code is described below. The product code is also the catalog number for the pump. **Note: Not all combinations are possible.**

Special Configurations (1-2 Characters)

- [P] = Passivization only
- [S] = Customized configuration
- [Z] = High Pressure

Seal Materials (1 Character)

- [0] = Carbon/SilCar/FKM
- [1] = Carbon/SilCar/AFLAS (High Temp)
- [2] = SilCar/SilCar/FKM
- [4] = SilCar/SilCar/EPR
- [6] = Carbon/SilCar/EPR

hydrovar X Version (1 Character)

- [X] = standard hydrovar X

Voltage (1 Character)

- [L] = 200-240V
- [X] = 380-480V

Pole-Hz-Phase (1 Character)

- [A] = 4-60-3 (1200-3600 RPM)

Motor HP (1 Character)

- [1] = 4 HP [L] = 20 HP
- [2] = 5.5 HP [M] = 25 HP
- [H] = 7.5 HP [N] = 30 HP
- [J] = 10 HP
- [K] = 15 HP

Configuration Option (1 Character)

- [C] = Clamp 316
 - [F] = Round-304 (SVB)
 - [G] = CI-304
 - [N] = Round-316 (SVD)
 - [P] = Victaulic-316
 - [T] = Oval-304 (SVA)
- Bottom & Top Location:**
- [R] = (SVC) 12Suct - 12Disch
 - [W] = (SVC) 12Suct - 03Disch
 - [X] = (SVC) 12Suct - 06Disch

Number of stages (1-2 Characters)

Omit special characters such as '/' and do not include 0 for single digit staging (i.e. 2 not 02).

Product Line (3 Characters)

[SVX] = e-SV stainless vertical multistage pump with hydrovar X

Nominal Flow (1-3 Characters)

- [1] = 5 GPM
- [3] = 16 GPM
- [5] = 26 GPM
- [10] = 53 GPM
- [15] = 80 GPM
- [22] = 116 GPM

* For CE compliant 50 Hz motors, please contact the factory

Example Product Code (33-125 e-SVX)*

125	SVX	1	0	C	G	L	A	X	X	0	
-----	-----	---	---	---	---	---	---	---	---	---	--

Special Configurations (1-2 Characters)

- [P] = Passivation only
- [S] = Customized configuration
- [Z] = High Pressure (250/300 psi pump body)

Seal Materials (1 Character)

- [0] = Carbon/SilCar/FKM
- [1] = Carbon/SilCar/AFLAS (High Temp)
- [2] = SilCar/SilCar/FKM
- [4] = SilCar/SilCar/EPR
- [6] = Carbon/SilCar/EPR

hydrovar X Version (1 Character)

- [X] = standard hydrovar X

Voltage (1 Character)

- [L] = 200-240V
- [X] = 380-480V

Pole-Hz-Phase (1 Character)

- [A] = 4-60-3 (1200-3600 RPM)

Motor HP (1 Character)

- [1] = 4 HP [K] = 15 HP
- [2] = 5.5 HP [L] = 20 HP
- [H] = 7.5 HP [M] = 25 HP
- [J] = 10 HP [N] = 30 HP

Configuration Option (1 Character)

- [G] = Round-CI-304
- [N] = Round-316

125SV ONLY (1 Character)

Reduced Trim Diameter C = 145 mm (full dia.) option, only. Blank if 33-92SV

Number of reduced trim impellers (1 Character)

The number of reduced trim impellers. If no reduced trim impellers are used, insert "0".

Total Number of Impeller Stages (may be 1 or 2 characters)

Do not include 0 for single digit staging (i.e. 2, not 02).

Product Line (3 Characters)

[SVX] = e-SV stainless vertical multistage pump with hydrovar X

Nominal Flow (1-3 Characters)

- [33] = 175 GPM
- [46] = 240 GPM
- [66] = 350 GPM
- [92] = 485 GPM
- [125] = 660 GPM

Other product code examples:

- Example (1-22SVX with special configuration): 1SVX30G1AXX0P
- Example (33-92SVX with no reduced trim impellers): 46SVX10GHAXX0
- Example (33-92SVX with reduced trim impellers): 46SVX21GKAXX0
- Example (125SVX with no reduced trim impellers, with reduced trim diameter): 125SVX10CNLAXX1

e-SVX Model Summary

e-SVX Type	Voltage	HP	Frame	Motor Type	Max Input Power (kW)	Max Input Current (A)
1SVX-30	460	4	143TC	EXM143-145/4.040BH2	3.13	5.74
1SVX-30	230	4	143TC	EXM143-145/3.040BH2	3.04	9.37

e-SVX Type	Voltage	HP	Frame	Motor Type	Max Input Power (kW)	Max Input Current (A)
3SVX-18	460	4	143TC	EXM143-145/4.040BH2	3.37	6.18
3SVX-25		5.5	143TC	EXM143-145/4.055BH2	4.58	7.81
3SVX-30		7.5	143TC	EXM143-145/4.075BH2	7.42	12.08
3SVX-18	230	4	143TC	EXM143-145/3.040BH2	3.39	10.45
3SVX-25		7.5	213TC	EXM213-215/3.075CH2	4.59	14.15
3SVX-30		7.5	213TC	EXM213-215/3.075CH2	7.42	22.88

e-SVX Type	Voltage	HP	Frame	Motor Type	Max Input Power (kW)	Max Input Current (A)
5SVX-11	460	4	143TC	EXM143-145/4.040BH2	3.34	6.13
5SVX-15		5.5	143TC	EXM143-145/4.055BH2	4.43	7.55
5SVX-21		7.5	143TC	EXM143-145/4.075BH2	6.20	10.1
5SVX-27		10	213TC	EXM213-215/4.100CH2	8.06	13.74
5SVX-11	230	4	143TC	EXM143-145/3.040BH2	3.38	10.42
5SVX-15		7.5	213TC	EXM213-215/3.075CH2	4.45	13.72
5SVX-21		7.5	213TC	EXM213-215/3.075CH2	6.17	19.03
5SVX-27		15	254TC	EXM254-256/3.150DH2	8.02	25.83

e-SVX Type	Voltage	HP	Frame	Motor Type	Max Input Power (kW)	Max Input Current (A)
10SVX-04	460	4	143TC	EXM143-145/4.040BH2	3.08	5.65
10SVX-05		5.5	143TC	EXM143-145/4.055BH2	3.75	6.39
10SVX-08		7.5	143TC	EXM143-145/4.075BH2	6.12	9.97
10SVX-10		10	213TC	EXM213-215/4.100CH2	7.75	13.21
10SVX-16		15	213TC	EXM213-215/4.150CH2	12.08	19.45
10SVX-20		20	254TC	EXM254-256/3.200DH2	15.03	28.66
10SVX-04	230	4	143TC	EXM143-145/3.040BH2	3.12	9.62
10SVX-05		7.5	213TC	EXM213-215/3.075CH2	3.79	11.69
10SVX-08		7.5	213TC	EXM213-215/3.075CH2	6.09	18.78
10SVX-10		15	254TC	EXM254-256/3.150DH2	7.71	24.83
10SVX-16		15	254TC	EXM254-256/3.150DH2	12.07	38.87
10SVX-20		20	254TC	EXM254-256/3.200DH2	15.19	47.86

e-SVX Type	Voltage	HP	Frame	Motor Type	Max Input Power (kW)	Max Input Current (A)
15SVX-02	460	5.5	143TC	EXM143-145/4.055BH2	3.32	5.66
15SVX-03		7.5	143TC	EXM143-145/4.075BH2	4.94	8.04
15SVX-04		10	213TC	EXM213-215/4.100CH2	6.59	11.24
15SVX-07		15	213TC	EXM213-215/4.150CH2	11.35	18.28
15SVX-09		20	254TC	EXM254-256/4.200DH2	14.41	27.48
15SVX-12		25	254TC	EXM254-256/4.250DH2	19.18	31.95
15SVX-14		30	254TC	EXM254-256/4.300DH2	22.29	35.89
15SVX-02	230	7.5	213TC	EXM213-215/3.075CH2	3.35	10.33
15SVX-03		7.5	213TC	EXM213-215/3.075CH2	4.94	15.23
15SVX-04		15	254TC	EXM254-256/3.150DH2	6.55	21.1
15SVX-07		15	254TC	EXM254-256/3.150DH2	11.32	36.46
15SVX-09		20	254TC	EXM254-256/3.200DH2	14.55	45.84

e-SVX Type	Voltage	HP	Frame	Motor Type	Max Input Power (kW)	Max Input Current (A)
22SVX-02	460	5.5	143TC	EXM143-145/4.055BH2	4.24	7.23
22SVX-03		7.5	143TC	EXM143-145/4.075BH2	6.24	10.16
22SVX-04		10	213TC	EXM213-215/4.100CH2	8.26	14.08
22SVX-07		15	213TC	EXM213-215/4.150CH2	12.28	19.77
22SVX-09		25	254TC	EXM254-256/4.250DH2	19.09	31.8
22SVX-12		30	254TC	EXM254-256/4.300DH2	24.18	38.94
22SVX-02	230	7.5	213TC	EXM213-215/3.075CH2	4.23	13.04
22SVX-03		7.5	213TC	EXM213-215/3.075CH2	6.23	19.21
22SVX-04		15	254TC	EXM254-256/3.150DH2	8.23	26.51
22SVX-07		15	254TC	EXM254-256/3.150DH2	12.35	39.77

e-SVX Type	Voltage	HP	Frame	Motor Type	Max Input Power (kW)	Max Input Current (A)
33SVX-1	460	7.5	213TC	EXM213-215/4.075CH2	4.88	7.95
33SVX-2/1		10	213TC	EXM213-215/4.100CH2	7.83	13.35
33SVX-2		15	213TC	EXM213-215/4.150CH2	11.10	17.87
33SVX-4/2		20	254TC	EXM254-256/4.200DH2	15.28	29.14
33SVX-4		25	254TC	EXM254-256/4.250DH2	19.13	31.87
33SVX-5		30	254TC	EXM254-256/4.300DH2	23.79	38.31
33SVX-1	230	7.5	213TC	EXM213-215/3.075CH2	4.92	15.17
33SVX-2/1		15	254TC	EXM254-256/3.150DH2	7.79	25.09
33SVX-2		15	254TC	EXM254-256/3.150DH2	11.07	35.65
33SVX-4/2		20	254TC	EXM254-256/3.200DH2	15.43	48.61

Commercial Water

e-SVX Type	Voltage	HP	Frame	Motor Type	Max Input Power (kW)	Max Input Current (A)
46SVX-1	460	7.5	213TC	EXM213-215/4.075CH2	6.39	10.41
46SVX-2/1		15	213TC	EXM213-215/4.150CH2	12.28	19.77
46SVX-3/2		20	254TC	EXM254-256/4.200DH2	16.20	30.89
46SVX-3		25	254TC	EXM254-256/4.250DH2	20.24	33.72
46SVX-4/1		30	254TC	EXM254-256/4.300DH2	24.18	38.94
46SVX-1	230	7.5	213TC	EXM213-215/3.075CH2	6.22	19.18
46SVX-2/1		15	254TC	EXM254-256/3.150DH2	12.26	39.48
46SVX-3/2		20	254TC	EXM254-256/3.200DH2	15.87	50

e-SVX Type	Voltage	HP	Frame	Motor Type	Max Input Power (kW)	Max Input Current (A)
66SVX-1	460	15	213TC	EXM213-215/4.150CH2	10.81	17.41
66SVX-2/2		20	254TC	EXM254-256/4.200DH2	14.16	27
66SVX-2/1		25	254TC	EXM254-256/4.250DH2	17.37	28.94
66SVX-2		30	254TC	EXM254-256/4.300DH2	20.87	33.61
66SVX-1	230	15	254TC	EXM254-256/3.150DH2	10.78	34.72
66SVX-2/2		20	254TC	EXM254-256/3.200DH2	14.33	45.15

e-SVX Type	Voltage	HP	Frame	Motor Type	Max Input Power (kW)	Max Input Current (A)
92SVX-1	460	20	254TC	EXM254-256/4.200DH2	14.75	28.13
92SVX-2/2		25	254TC	EXM254-256/4.250DH2	20.24	33.72
92SVX-2/1		30	254TC	EXM254-256/4.300DH2	24.18	38.94
92SVX-1	230	20	254TC	EXM254-256/3.200DH2	14.89	46.91

e-SVX Type	Voltage	HP	Frame	Motor Type	Max Input Power (kW)	Max Input Current (A)
125SVX-1/0C	460	20	254TC	EXM254-256/4.200DH2	15.09	28.78
125SVX-1/0C	230	20	254TC	EXM254-256/3.200DH2	15.24	48.02

e-SVX SERIES e-SV with hydrovar X

hydrovar X offers a graphical color display and startup genie that makes navigation and first-time setup easier than ever.

hydrovar X



Drive position

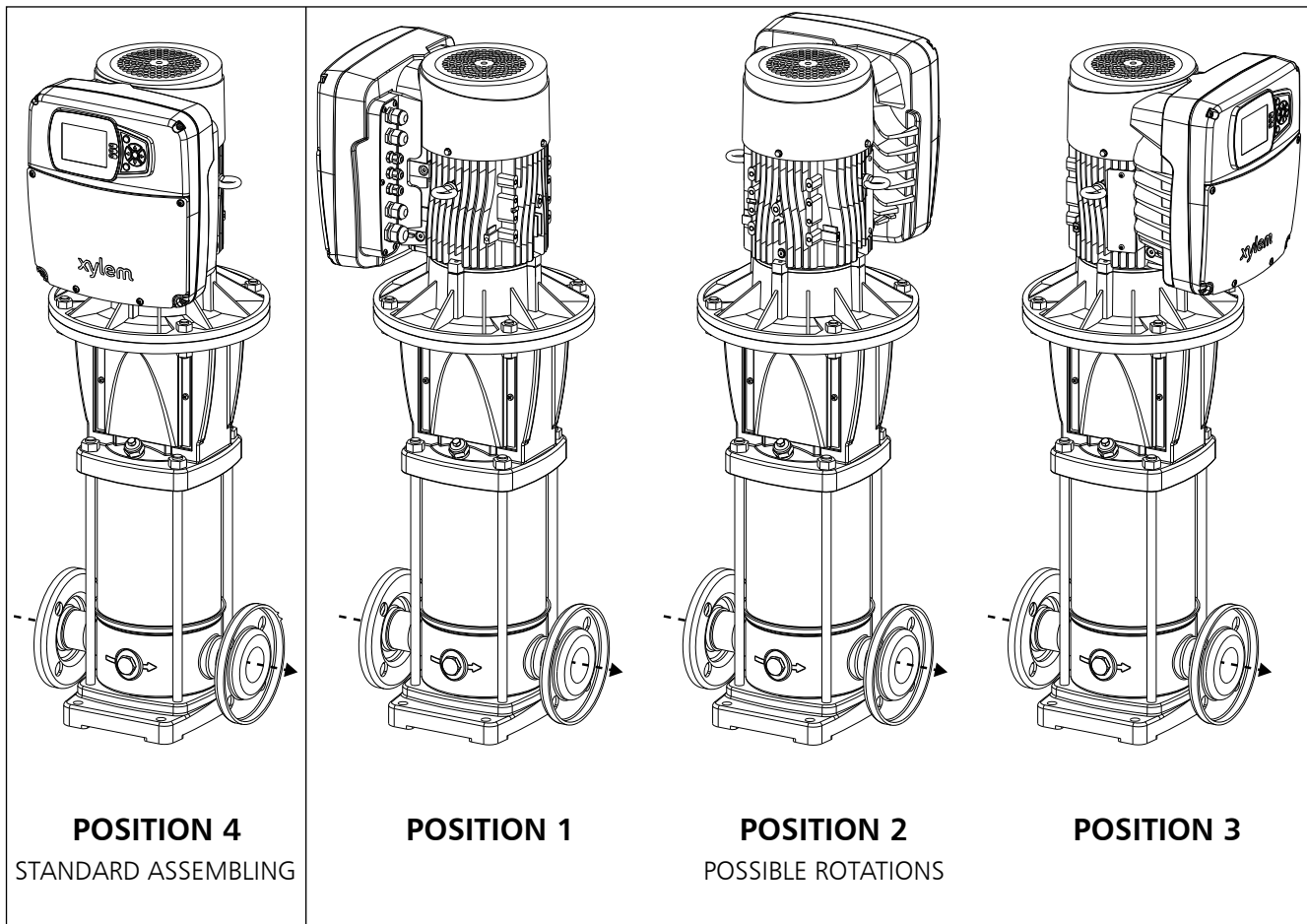

POSITION 4

STANDARD ASSEMBLING

POSITION 1

POSITION 2

POSSIBLE ROTATIONS

POSITION 3

Commercial Water

TERMINAL BLOCK hydrovar X

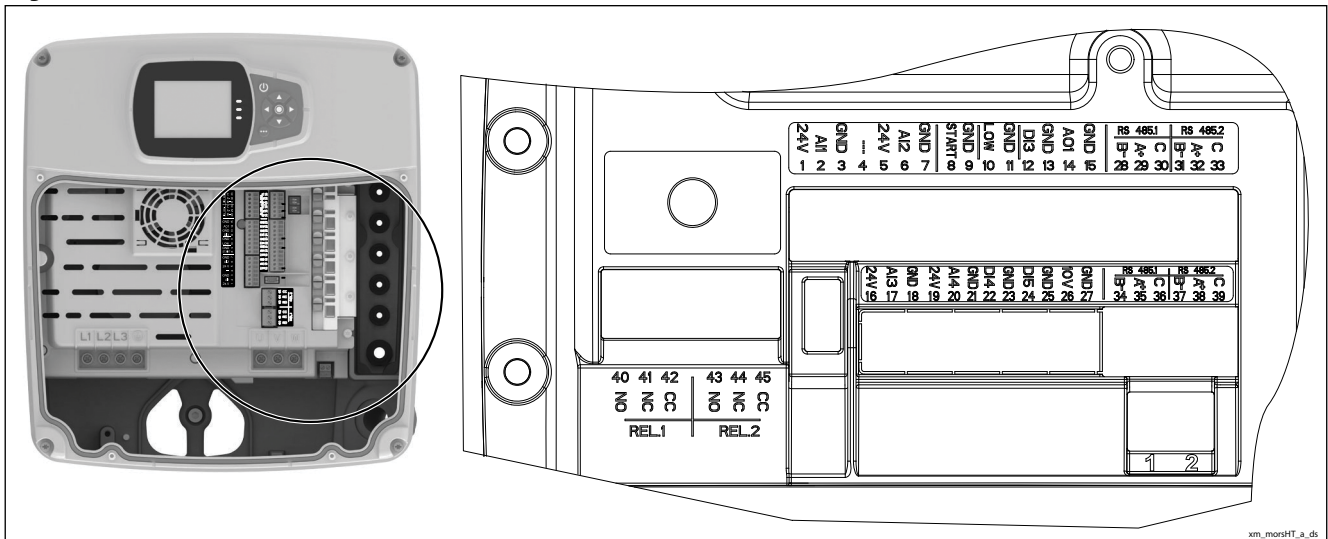

REF.	ITEM	DESCRIPTION	DEFAULT
1		Power supply +24 VDC, max. 60mA (total, terminals 1 + 5)	
2	Analog Input 1	Configurable Analog Input 1	Pressure Sensor 1
3		Electronic GND	
4	Not used	Internal use - Do not connect	
5		Power supply +24 VDC, max. 60mA (total, terminals 1 + 5)	
6	Analog Input 2	Configurable Analog Input 2	Not used
7		Electronic GND	
8	External Start/Stop	Start/Stop digital input, +24 VDC internal pull-up, 6mA contact current	-
9		Electronic GND	
10	External Lack of Water	Low water digital input, +24 VDC internal pull-up, 6mA contact current	-
11		Electronic GND	
12	Digital Input 3	Configurable Digital Input 3, +24 VDC internal pull-up, 6mA contact current	Solo Run
13		Electronic GND	
14	Analog Output	Configurable Analog Output	Motor Speed
15		Electronic GND	
16		Power supply +24 VDC, max. 60mA (total, terminals 16 and 19)	
17	Analog Input 3	Configurable Analog Input 3	Not used
18		Electronic GND	
19		Power supply +24 VDC, max. 60mA (total, terminals 16 and 19)	
20	Analog Input 4	Configurable Analog Input 4	Not used
21		Electronic GND	
22	Digital Input 4	Configurable Digital Input 4, +24 VDC internal pull-up, 6mA contact current	Not used
23		Electronic GND	
24	Digital Input 5	Configurable Digital Input 5, +24 VDC internal pull-up, 6mA contact current	Not used
25		Electronic GND	
26	10 VDC supply	Power supply +10 VDC, max. 3mA	-
27		Electronic GND	
28		RS485 port 1: RS485-1B N (-)	
29	Communication bus 1	RS485 port 1: RS485-1A P (+)	Multipump
30		RS485 port 1: RS485-COM	
31		RS485 port 2: RS485-2B N (-)	
32	Communication bus 2	RS485 port 2: RS485-2A P (+)	Modbus
33		RS485 port 2: RS485-COM	
34		RS485 port 1: RS485-1B N (-)	
35	Communication bus 1	RS485 port 1: RS485-1A P (+)	Multipump
36		RS485 port 1: RS485-COM	
37		RS485 port 2: RS485-2B N (-)	
38	Communication bus 2	RS485 port 2: RS485-2A P (+)	Modbus
39		RS485 port 2: RS485-COM	
40		Configurable relay 1: Normally Open	
41	Relay 1	Configurable relay 1: Normally Closed	Running
42		Configurable relay 1: Common Contact	
43		Configurable relay 2: Normally Open	
44	Relay 2	Configurable relay 2: Normally Closed	Error
45		Configurable relay 2: Common Contact	

e-SVX SERIES HOW TO READ SMART PUMP SERIES CURVES

To exploit to the maximum potential of Smart Pumps it's important to properly read working curves:

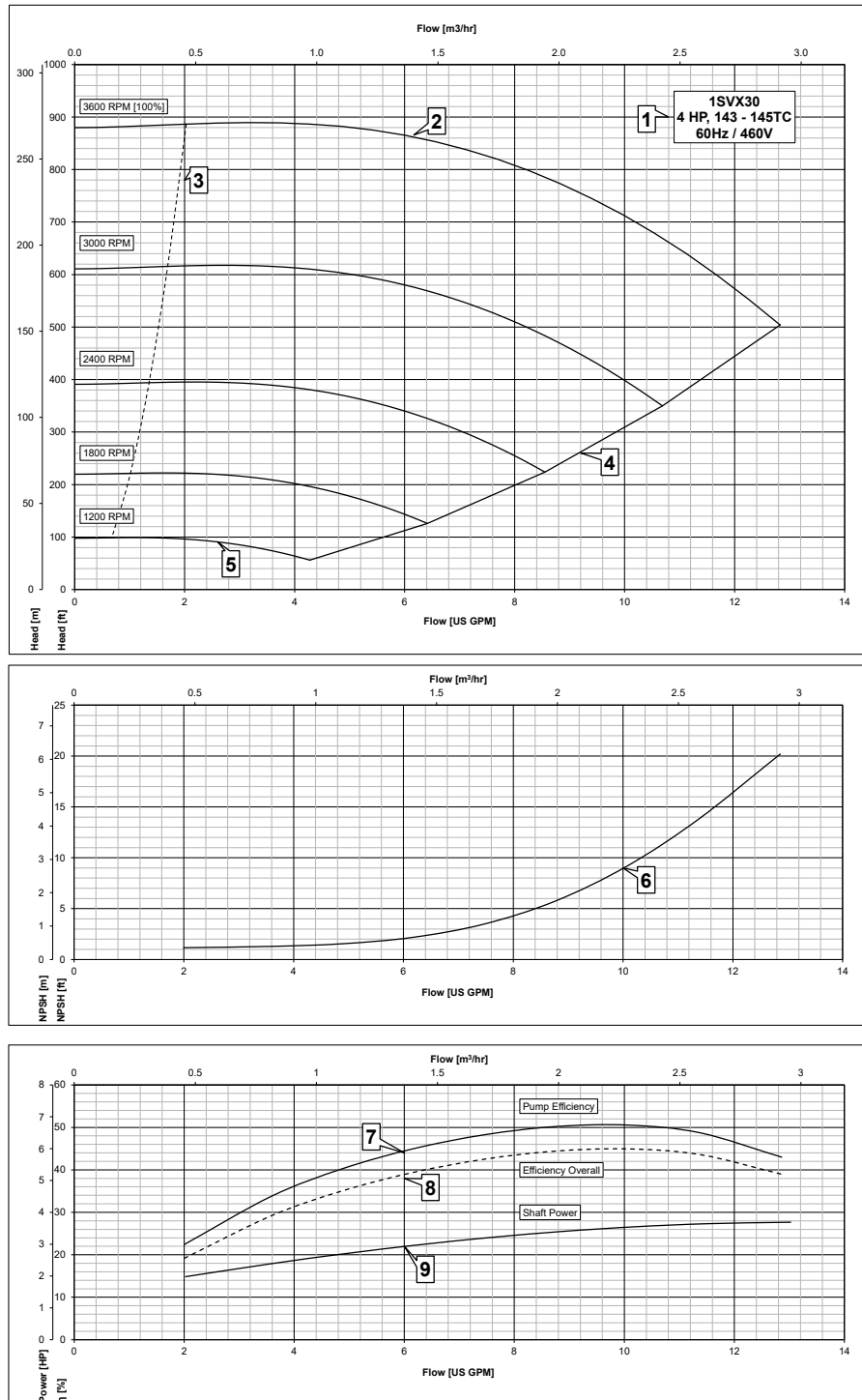

The performances are valid for liquid with density $\rho = 1 \text{ Kg/dm}^3$ and kinematic viscosity $\nu = 1 \text{ mm}^2/\text{sec}$.

- ① **Model information:** pump model and motor information.
- ② **Maximum speed curve:** the maximum operating speed of the pump. The [100%] tag indicates the default maximum speed setting of the motor.
- ③ **Minimum continuous stable flow:** the recommended minimum flow rate of the pump.
- ④ **Maximum flow curve:** the maximum flow rate of the pump.
- ⑤ **Minimum speed curve:** the minimum operating speed of the pump.
- ⑥ **NPSHr curve:** the net positive suction head of the pump operating at maximum speed.
- ⑦ **Pump Efficiency:** the efficiency of the standalone pump operating at the default maximum speed which represents the ratio of hydraulic power to shaft input power.
- ⑧ **Efficiency overall:** the net efficiency of the pump, motor and drive operating at the default maximum speed.
- ⑨ **Shaft power:** the shaft input power required to drive the pump operating at the maximum pump speed.

e-SVX SERIES - ELECTRICAL DATA TABLES

The full-load nominal motor power is guaranteed in the 3000-4000 rpm range unless otherwise indicated. The standard e-SVX offering operates below 3600 rpm and is automatically limited to 3600 rpm; the motor can operate partially loaded below 3000 rpm.

hydrovar X - ELECTRICAL DATA

THREE-PHASE, 56 Frame, 380-480V

Pn HP	MOTOR TYPE	NEMA FRAME	SPEED (RPM) min-1	INPUT CURRENT (I) 380-480V A	DATA RELATED TO 460V					
					In A	POWER FACTOR cos(φ)	Tn lb.ft	* PDS EFFICIENCY		
								100	75	50
4.0	EXM56/4.040BH2	56	3000	5.90-5.23	5.37	0.80	7.04	87.6	87.5	86.0
			3600		5.35		5.87	88.0	87.4	85.4
			4000		5.40		5.28	88.1	87.1	84.9

THREE-PHASE, 56 Frame, 200-240V

Pn HP	MOTOR TYPE	NEMA FRAME	SPEED (RPM) min-1	INPUT CURRENT (I) 200-240V A	DATA RELATED TO 230V					
					In A	POWER FACTOR cos(φ)	Tn lb.ft	* PDS EFFICIENCY		
								100	75	50
4.0	EXM56/3.040BH2	56	-	10.7-8.9	-	0.94	-	-	-	-
			3600		9.2		5.87	87.2	87.1	85.9
			4000		9.1		5.28	88.0	87.8	86.4

THREE-PHASE, 143-145 Frame, 380-480V

Pn HP	MOTOR TYPE	NEMA FRAME	SPEED (RPM) min-1	INPUT CURRENT (I) 380-480V A	DATA RELATED TO 460V					
					In A	POWER FACTOR cos(φ)	Tn lb.ft	* PDS EFFICIENCY		
								100	75	50
4.0	EXM143-145/4.040BH2	143-145	3000	6.7-5.3	5.4	0.80	7.04	87.6	87.5	86.0
			3600		5.3		5.87	88.0	87.4	85.4
			4000		5.3		5.28	88.1	87.1	84.9
5.5	EXM143-145/4.055BH2		3000	7.7-6.6	6.8	0.86	9.39	87.3	87.7	87.5
			3600		6.6		7.83	89.1	88.8	87.3
			4000		6.5		7.04	89.1	88.5	86.8
7.5	EXM143-145/4.075BH2		3000	10.2-8.4	8.6	0.89	12.91	89.9	89.9	89.2
			3600		8.6		10.76	89.7	89.5	88.5
			4000				9.68	90.5	89.4	87.4

* Efficiency values shown are power-drive-system (PDS) efficiencies which include the combined losses from both the inverter and motor. The values shown correspond to the full load range of the hydrovar X motor. The hydrovar X motor may operate below the minimum rated speed at partial loading.

THREE-PHASE, 143-145 Frame, 200-240V

Pn HP	MOTOR TYPE	NEMA FRAME	SPEED (RPM) min-1	INPUT CURRENT (I) 200-240V A	DATA RELATED TO 460V					
					In A	POWER FACTOR cos(φ)	Tn lb.ft	* PDS EFFICIENCY		
								100	75	50
4.0	EXM143-145/3.040BH2	143-145	3000	10.7-8.9	8.6	0.94	6.34	85.8	85.9	85.2
			3600		9.2		5.87	87.2	87.1	85.9
			4000		9.1		5.28	88.0	87.8	86.4
5.5	EXM143-145/3.055BH2		3000	Unavailable						
			3600							
			4000							
7.5	EXM143-145/3.075BH2		3000	Unavailable						
			3600							
			4000							

THREE-PHASE, 213-215 Frame, 380-480V

Pn HP	MOTOR TYPE	NEMA FRAME	SPEED (RPM) min-1	INPUT CURRENT (I) 380-480V A	DATA RELATED TO 460V					
					In A	POWER FACTOR cos(φ)	Tn lb.ft	* PDS EFFICIENCY		
								100	75	50
7.50	EXM213-215/4.075CH2	213-215	3000	11.4-11.0	11.1	0.72	12.92	90.5	90.1	88.8
			3600		10.6		10.76	90.8	90.1	88.5
			4000		10.6		9.68	90.5	89.5	87.4
10.0	EXM213-215/4.100CH2		3000	14.4-12.5	12.2	0.85	17.61	90.8	90.1	88.4
			3600		12.4		14.67	90.2	89.2	87.0
			4000		12.0		13.20	90.6	89.5	87.1
15.0	EXM213-215/4.150CH2		3000	20.3-16.5	16.8	0.90	25.82	91.2	90.7	89.3
			3600		16.9		21.52	91.1	90.5	89.1
			4000				19.37	90.6	90.2	88.4

THREE-PHASE, 213-215 Frame, 200-240V

Pn HP	MOTOR TYPE	NEMA FRAME	SPEED (RPM) min-1	INPUT CURRENT (I) 200-240V A	DATA RELATED TO 460V					
					In A	POWER FACTOR cos(φ)	Tn lb.ft	* PDS EFFICIENCY		
								100	75	50
7.50	EXM213-215/3.075CH2	213-215	3000	18.9-16.2	16.7	0.94	12.92	89.6	89.3	88.2
			3600		16.3		10.76	89.9	89.2	87.6
			4000		16.6		9.68	88.6	87.6	85.1
10.0	EXM213-215/3.100CH2		3000	Unavailable						
			3600							
			4000							
15.0	EXM213-215/3.150CH2		3000	Unavailable						
			3600							
			4000							

* Efficiency values shown are power-drive-system (PDS) efficiencies which include the combined losses from both the inverter and motor. The values shown correspond to the full load range of the hydrovar X motor. The hydrovar X motor may operate below the minimum rated speed at partial loading.

THREE-PHASE, 254-256 Frame, 380-480V

Pn HP	MOTOR TYPE	NEMA FRAME	SPEED (RPM) min-1	INPUT CURRENT (I) 380-480V A	DATA RELATED TO 460V					
					In A	POWER FACTOR cos(φ)	Tn lb.ft	* PDS EFFICIENCY		
								100	75	50
15.00	EXM254-256/4.150DH2	254-256	3000	24.5-22.8	21.7	0.72	25.82	91.7	91.2	90.2
			3600		20.9		21.52	92.0	91.2	89.9
			4000		20.5		19.37	91.5	90.6	88.8
20.0	EXM254-256/4.200DH2		3000	30.2-27.1	24.5	0.76	35.22	91.5	91.2	90.1
			3600		27.0		29.35	92.1	91.4	90.1
			4000		26.8		26.41	91.8	91.1	89.6
25.0	EXM254-256/4.250DH2		3000	33.5-28.6	29.4	0.87	43.44	91.7	91.4	90.7
			3600		28.9		36.19	92.1	91.5	90.4
			4000		28.8		32.58	92.0	91.4	90.2
30.0	EXM254-256/4.300DH2		3000	38.9-32.4	33.5	0.90	51.65	92.1	91.7	90.7
			3600		33.3		43.04	92.5	91.8	90.6
			4000				38.83	92.4	91.6	90.2

THREE-PHASE, 254-256 Frame, 200-240V

Pn HP	MOTOR TYPE	NEMA FRAME	SPEED (RPM) min-1	INPUT CURRENT (I) 200-240V A	DATA RELATED TO 460V					
					In A	POWER FACTOR cos(φ)	Tn lb.ft	* PDS EFFICIENCY		
								100	75	50
15.00	EXM254-256/3.150DH2	254-256	3000	38.4-34.1	35.4	0.90	25.82	90.3	90.3	89.4
			3600		33.7		21.52	91.2	90.8	89.7
			4000		32.5		19.37	91.3	90.6	89.3
20.0	EXM254-256/3.200DH2		3000	50.0-44.1	-	0.92	-	-	-	-
			3600		44.9		29.35	91.1	90.6	89.5
			4000				26.41	90.3	89.4	87.5
25.0	EXM254-256/3.250DH2		3000	Unavailable						
			3600							
			4000							
30.0	EXM254-256/3.300DH2		3000	Unavailable						
			3600							
			4000							

* Efficiency values shown are power-drive-system (PDS) efficiencies which include the combined losses from both the inverter and motor. The values shown correspond to the full load range of the hydrovar X motor. The hydrovar X motor may operate below the minimum rated speed at partial loading.

Commercial Water

1, 3, 5SVX SERIES DIMENSIONS AND WEIGHTS

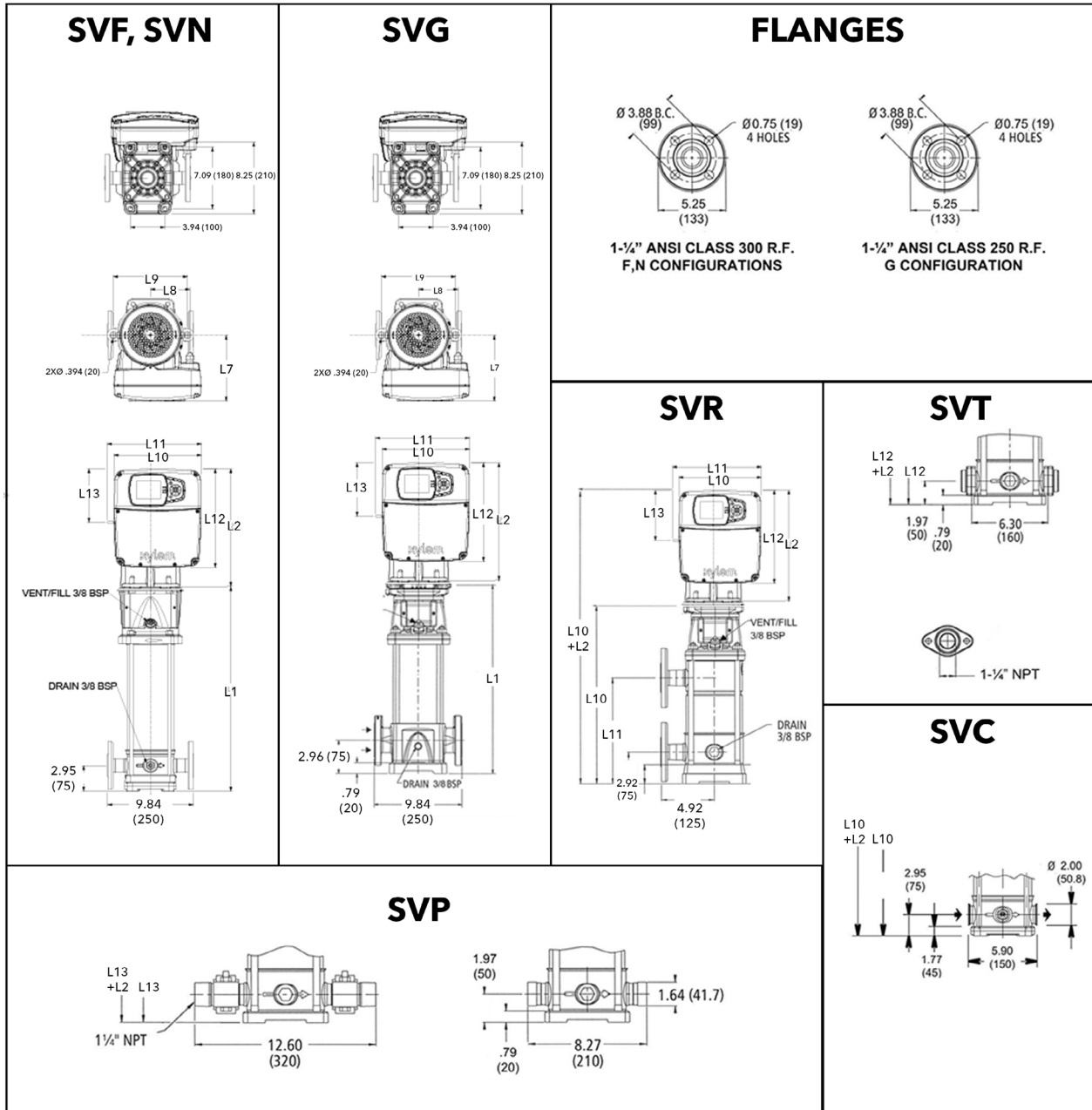

Commercial Water

1SVX SERIES - 60 HZ, 3600 RPM TEFC ENCLOSURES

Pump Type Stages	Motor				Dimensions (in)													Weight (lbs.)		
	Voltage	HP	NEMA Frame	Motor Type	L1	L2	L3	L4	L5	L6	L7	L8	L9	L10	L11	L12	L13	Pump Only	Motor	
			"TEFC 3Ø"																	
1SVX-30	380-480	4	143TC	EXM143-145TC/4.040BH2	34.53	13.53	10.078	10.828	11.359	6.148	7.618	4.531	8.504	-	-	-	33.55	43	45	88
	200-240	4	143TC	EXM143-145TC/3.040BH2	34.53	13.53	10.078	10.828	11.359	6.148	7.618	4.531	8.504	-	-	-	33.55	43	45	88

3SVX SERIES - 60 HZ, 3600 RPM TEFC ENCLOSURES

Pump Type Stages	Motor				Dimensions (in)													Weight (lbs.)		
	Voltage	HP	NEMA Frame	Motor Type	L1	L2	L3	L4	L5	L6	L7	L8	L9	L10	L11	L12	L13	Pump Only	Motor	Pump/Motor
			"TEFC 3Ø"																	
3SVX-18	380-480	4	143TC	EXM143-145TC/4.040BH2	25.78	13.53	10.078	10.828	11.359	6.148	7.618	4.531	8.504	25.78	16.81	-	24.8	43	45	88
	200-240	4	143TC	EXM143-145TC/3.040BH2	25.78	13.53	10.078	10.828	11.359	6.148	7.618	4.531	8.504	25.78	16.81	-	24.8	43	45	88
3SVX-25	380-480	5.5	143TC	EXM143-145TC/4.055BH2	31.29	13.53	10.078	10.828	11.359	6.148	7.618	4.531	8.504	-	-	-	30.31	49	47	96
	200-240	7.5	213TC	EXM213-215TC/3.075CH2	31.29	16.14	11.885	12.983	13.095	8.207	9.484	5.321	10.433	-	-	-	30.31	49	112	161
3SVX-30	380-480	7.5	143TC	EXM213-215TC/4.075CH2	35.23	13.53	10.078	10.828	11.359	6.148	7.618	4.531	8.504	-	-	-	34.25	55	55	110
	200-240	7.5	213TC	EXM213-215TC/3.075CH2	35.23	16.14	11.885	12.983	13.095	8.207	9.484	5.321	10.433	-	-	-	34.25	55	112	167

5SVX SERIES - 60 HZ, 3600 RPM TEFC ENCLOSURES

Pump Type Stages	Motor				Dimensions (in)													Weight (lbs.)		
	Voltage	HP	NEMA Frame	Motor Type	L1	L2	L3	L4	L5	L6	L7	L8	L9	L10	L11	L12	L13	Pump Only	Motor	Pump/Motor
			"TEFC 3Ø"																	
5SVX-11	380-480	4	143TC	EXM143-145TC/4.040BH2	22.44	13.53	10.078	10.828	11.359	6.148	7.618	4.531	8.504	22.44	13.46	21.45	21.45	37	47	84
	200-240	4	143TC	EXM143-145TC/3.040BH2	22.44	13.53	10.078	10.828	11.359	6.148	7.618	4.531	8.504	22.44	13.46	21.45	21.45	37	47	84
5SVX-15	380-480	5.5	143TC	EXM143-145TC/4.055BH2	26.37	13.53	10.078	10.828	11.359	6.148	7.618	4.531	8.504	26.37	17.4	-	25.39	41	47	88
	200-240	7.5	213TC	EXM213-215TC/3.075CH2	26.37	16.14	11.885	12.983	13.095	8.207	9.484	5.321	10.433	26.37	17.4	-	25.39	41	112	153
5SVX-21	380-480	7.5	143TC	EXM143-145TC/4.075BH2	32.28	13.53	10.078	10.828	11.359	6.148	7.618	4.531	8.504	32.28	23.31	-	31.29	49	55	104
	200-240	7.5	213TC	EXM213-215TC/3.075CH2	32.28	16.14	11.885	12.983	13.095	8.207	9.484	5.321	10.433	32.28	23.31	-	31.29	49	112	161
5SVX-27	380-480	10	213TC	EXM213-215TC/4.100CH2	38.84	16.14	11.885	12.983	13.095	8.207	9.484	5.321	10.433	-	-	-	37.86	62	97	159
	200-240	15	254TC	EXM254-256TC/3.150DH2	40.96		14.248	15.16	15.723	9.567	12.169	6.585	12.5	-	-	-	37.86	62	148	210

* Maximum value in specified range; PN = HP Rating; P1 = input power; I = input current.

1SVX30 OPERATING CHARACTERISTICS

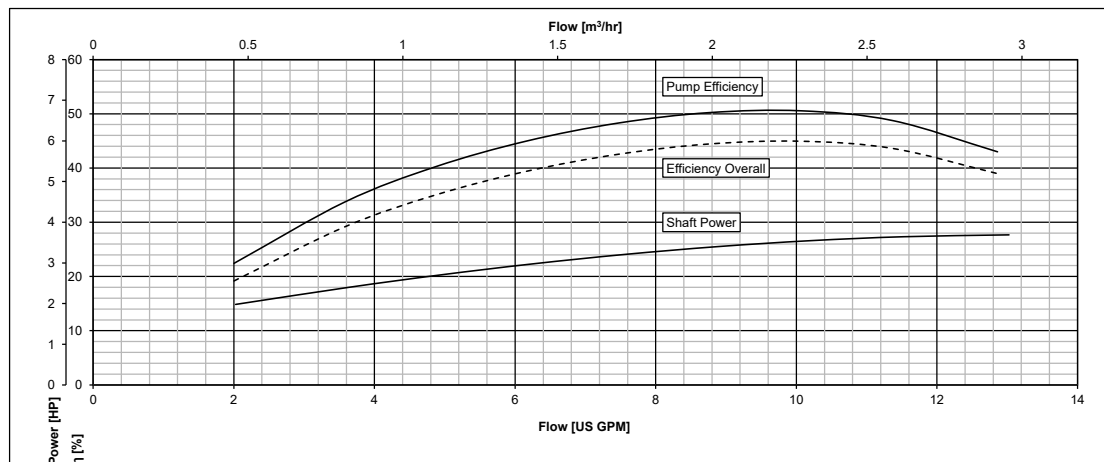
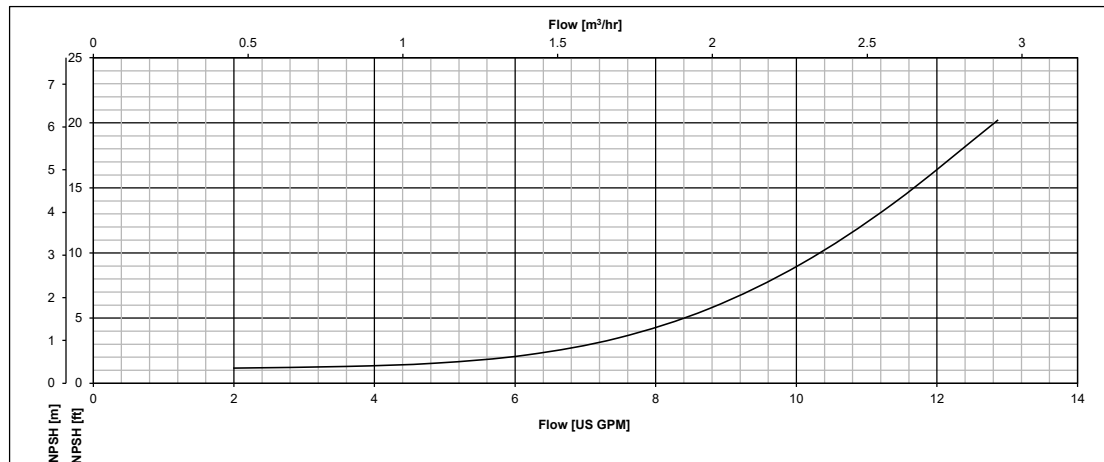
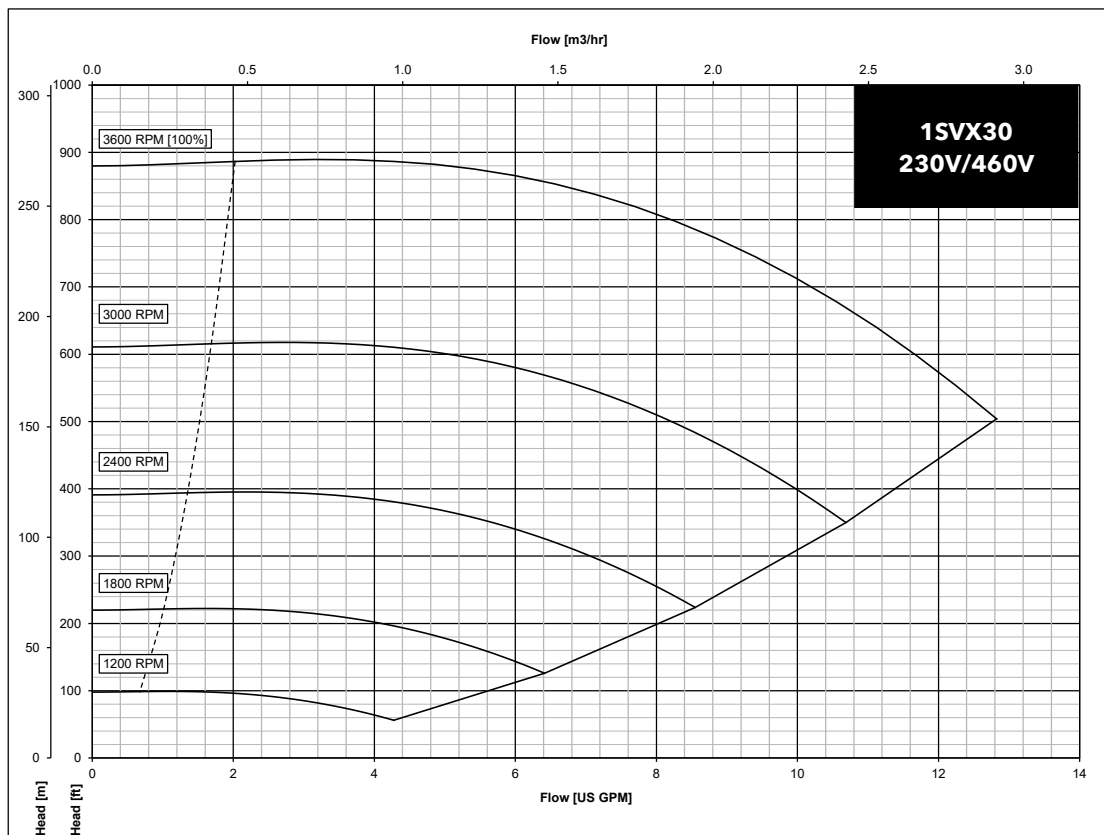

The performances are valid for liquid with density $\rho = 1.0 \text{ Kg/dm}^3$ and kinematic viscosity $\nu = 1 \text{ mm}^2/\text{sec}$.

3SVX18 OPERATING CHARACTERISTICS

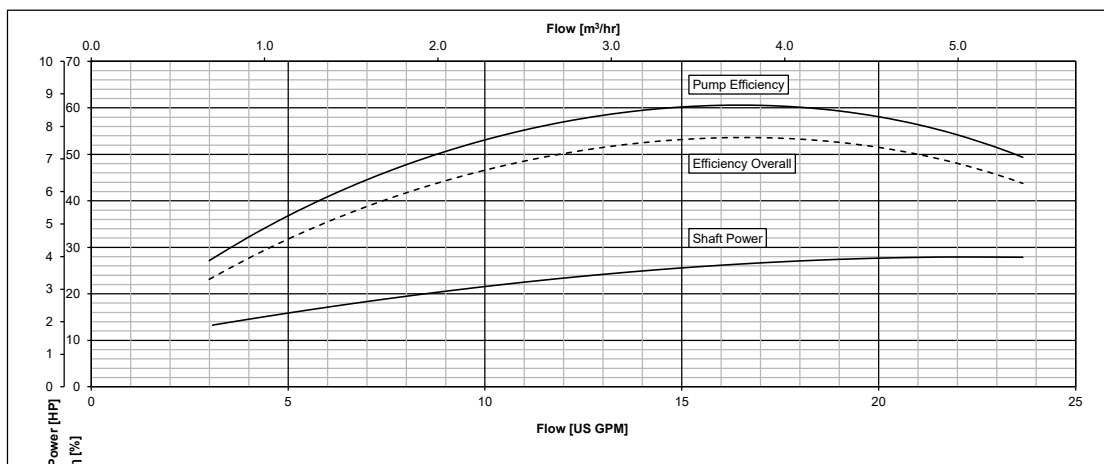
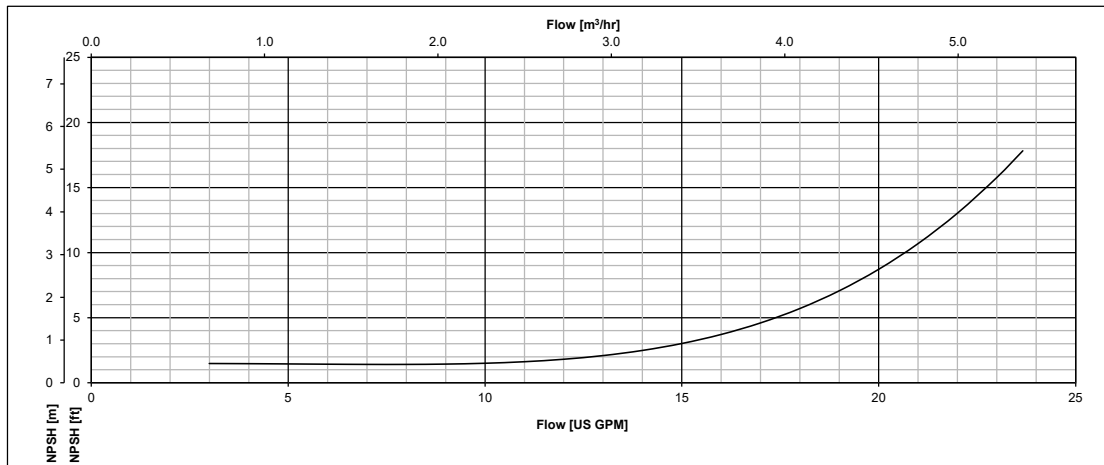
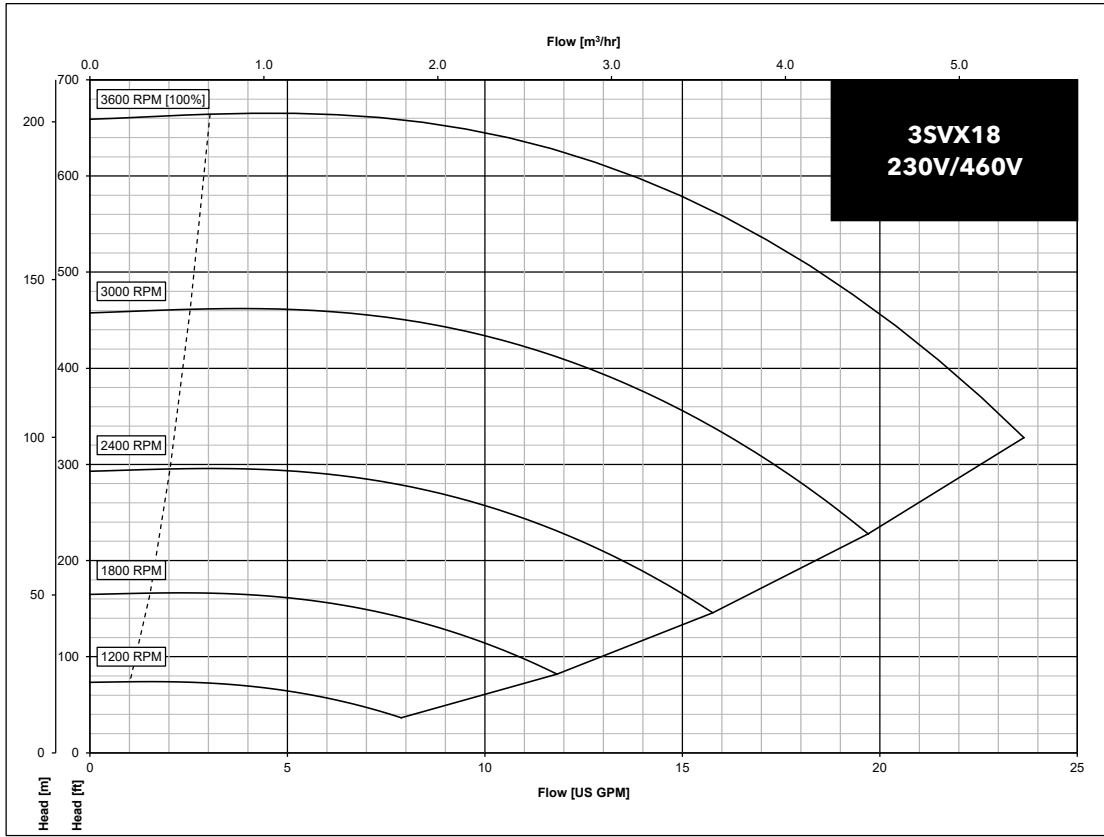

3SVX25 OPERATING CHARACTERISTICS

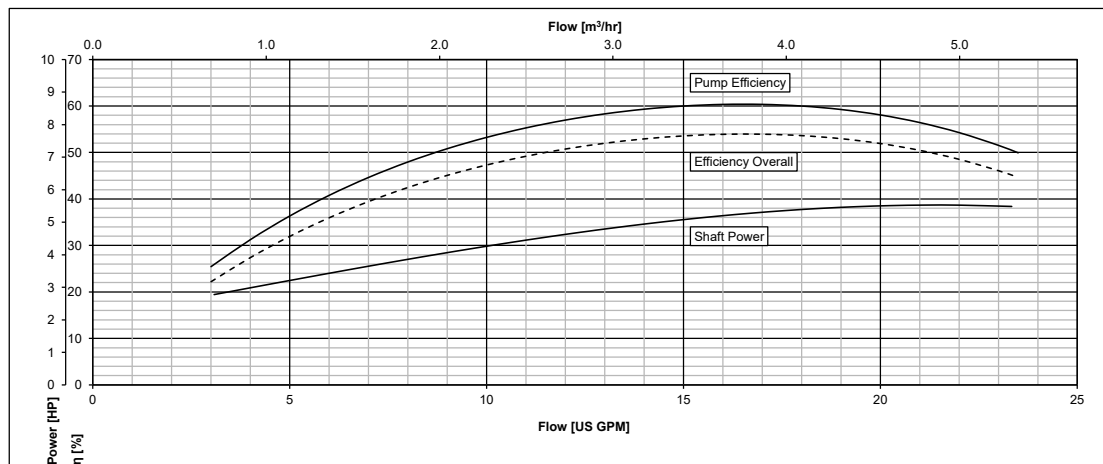
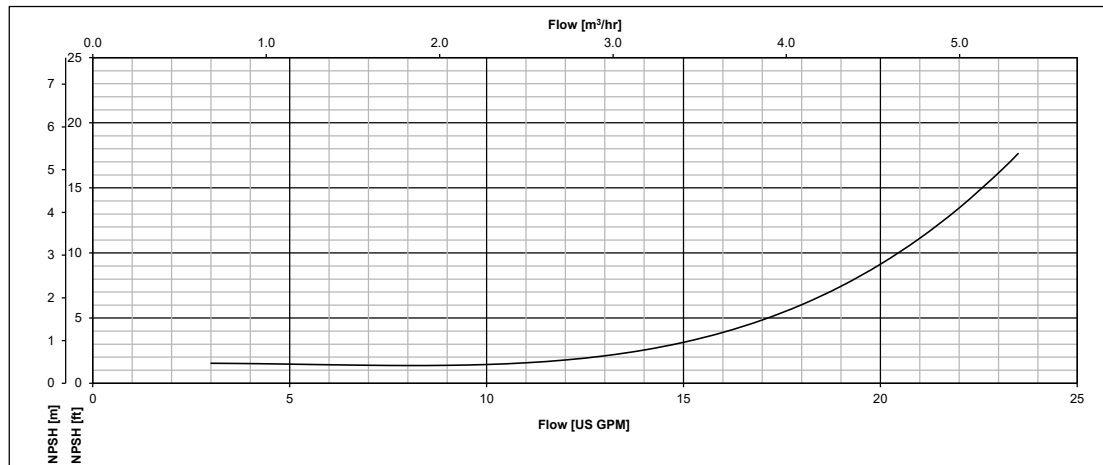
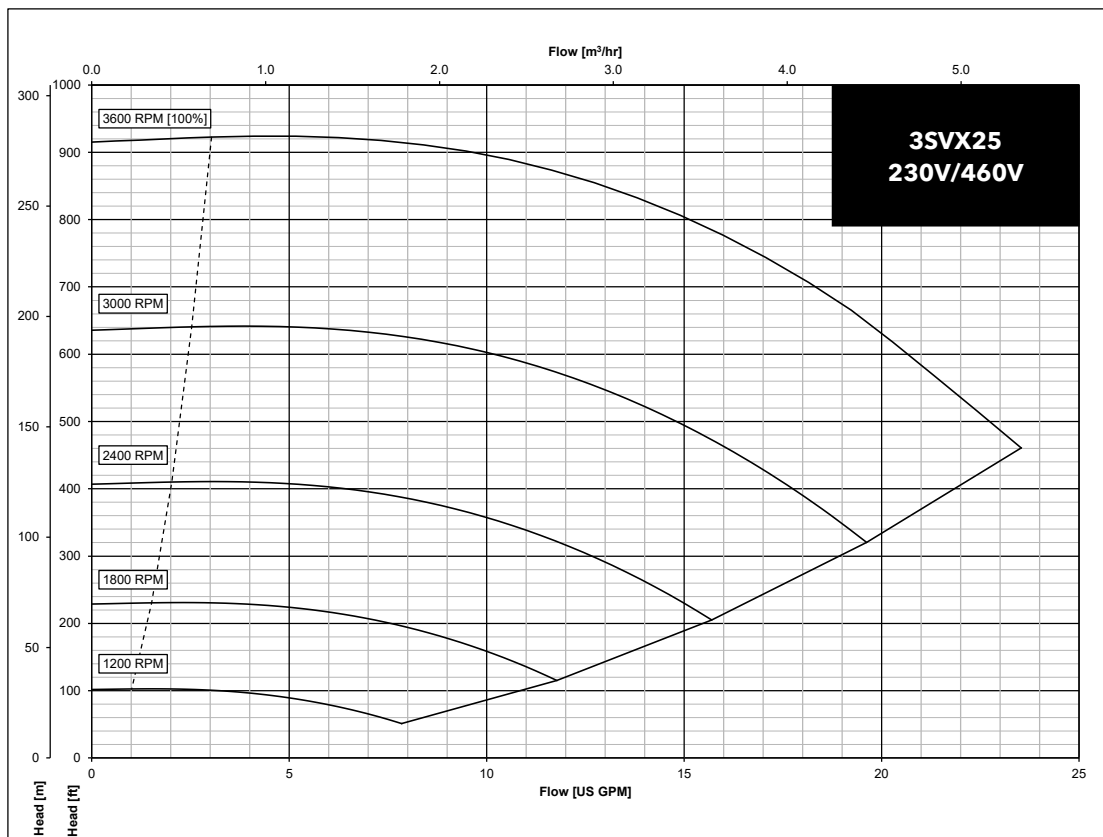

The performances are valid for liquid with density $\rho = 1.0 \text{ Kg/dm}^3$ and kinematic viscosity $\nu = 1 \text{ mm}^2/\text{sec}$.

3SVX30 OPERATING CHARACTERISTICS

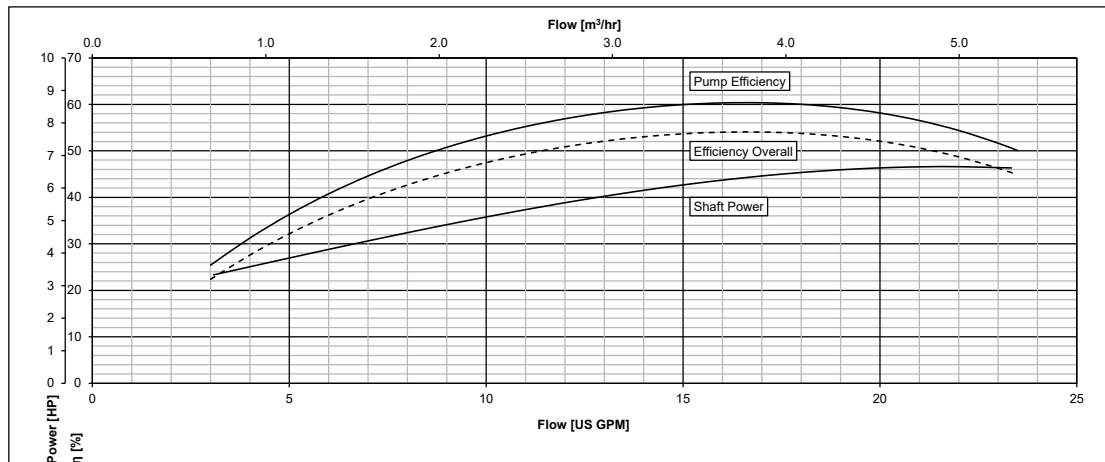
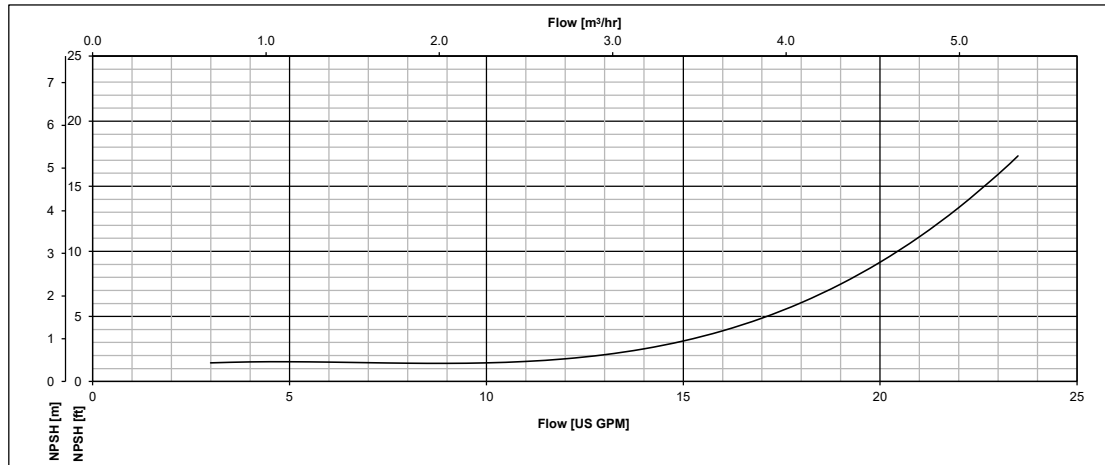
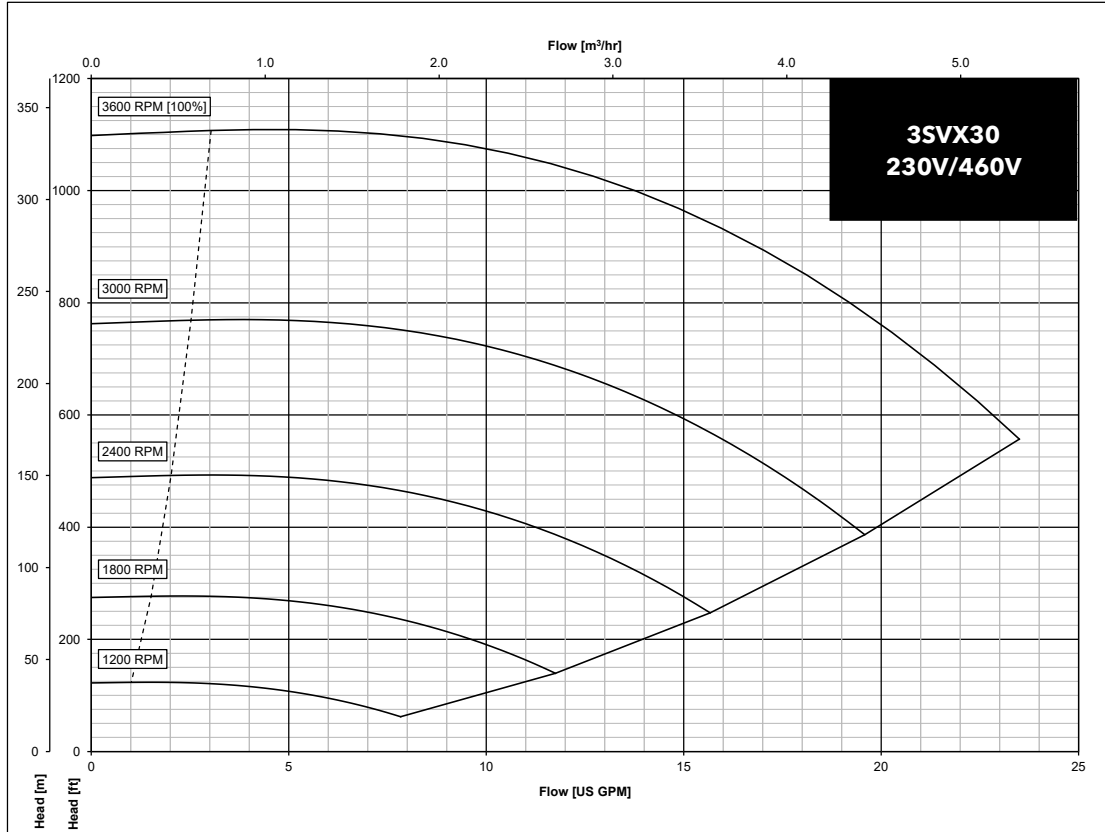

5SVX11 OPERATING CHARACTERISTICS

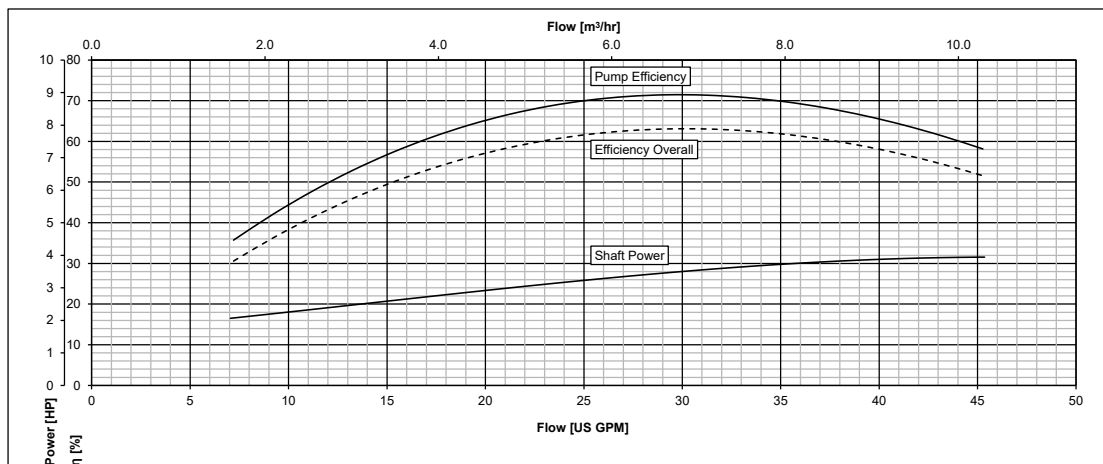
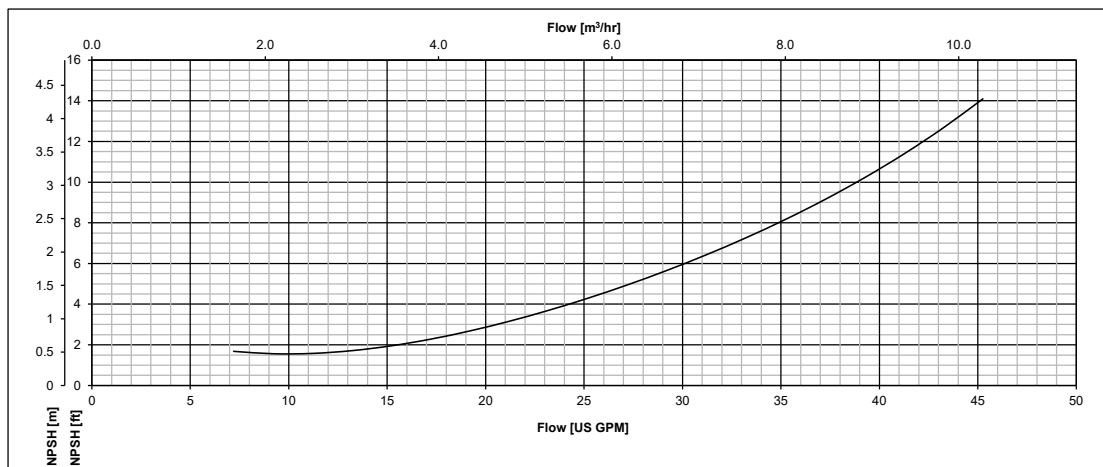
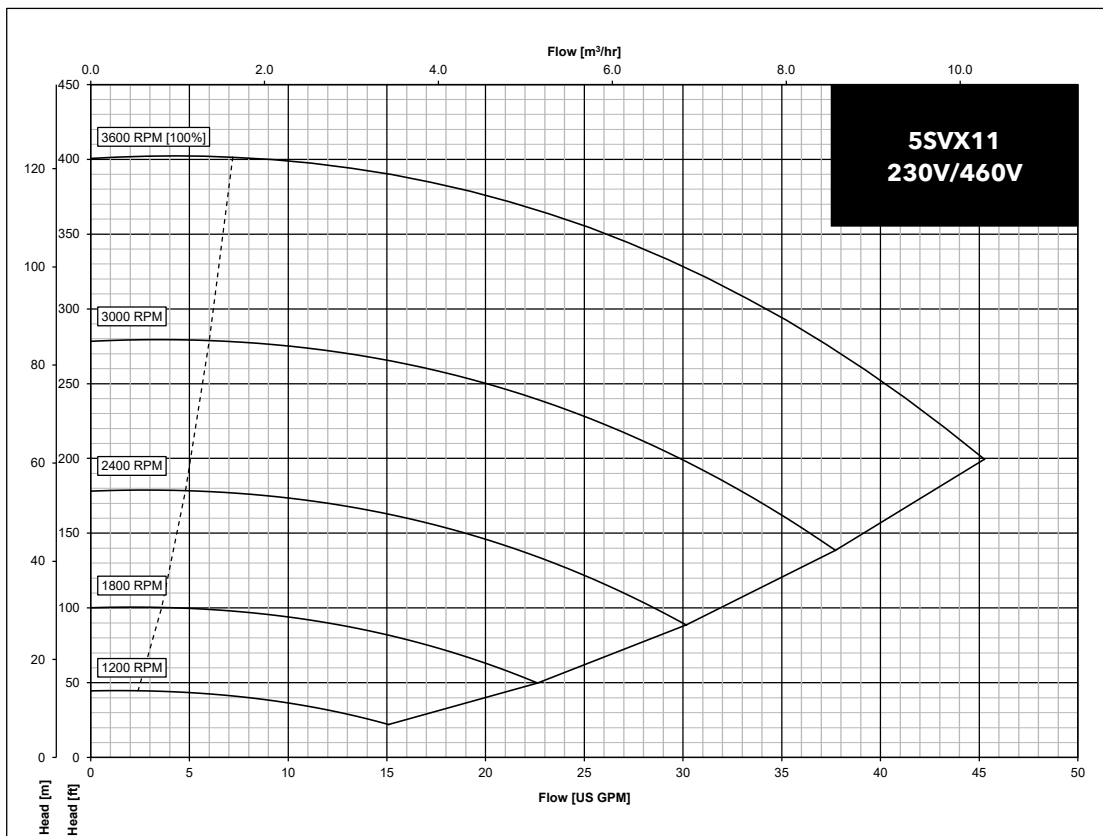

The performances are valid for liquid with density $\rho = 1.0 \text{ Kg/dm}^3$ and kinematic viscosity $\nu = 1 \text{ mm}^2/\text{sec}$.

5SVX15 OPERATING CHARACTERISTICS

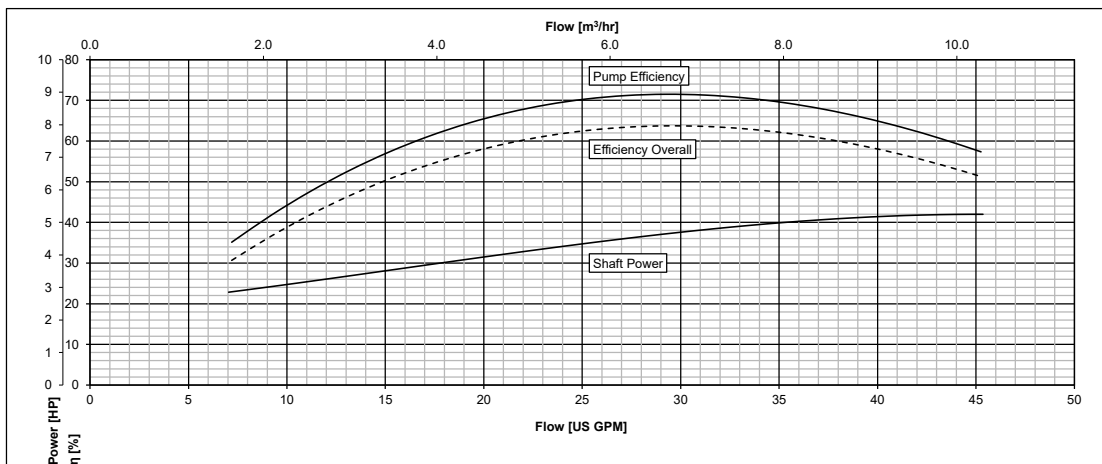
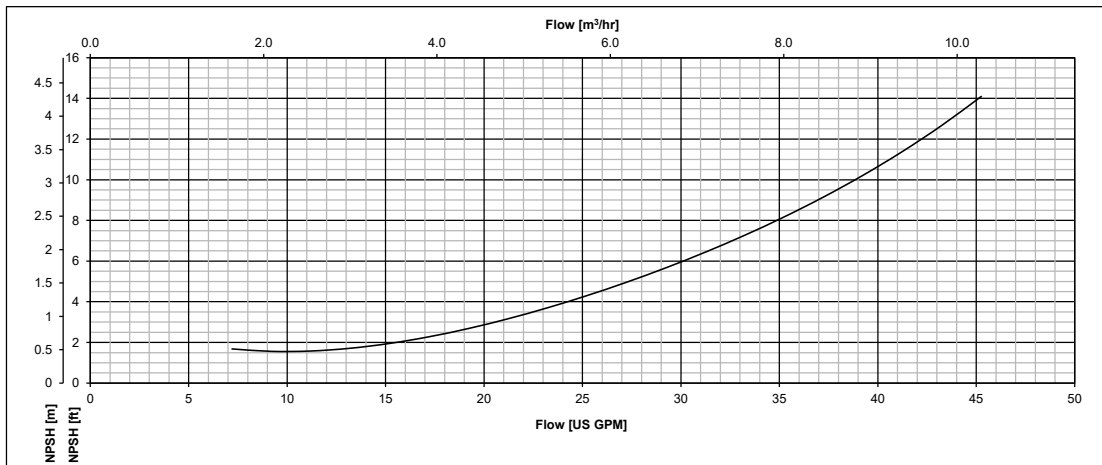
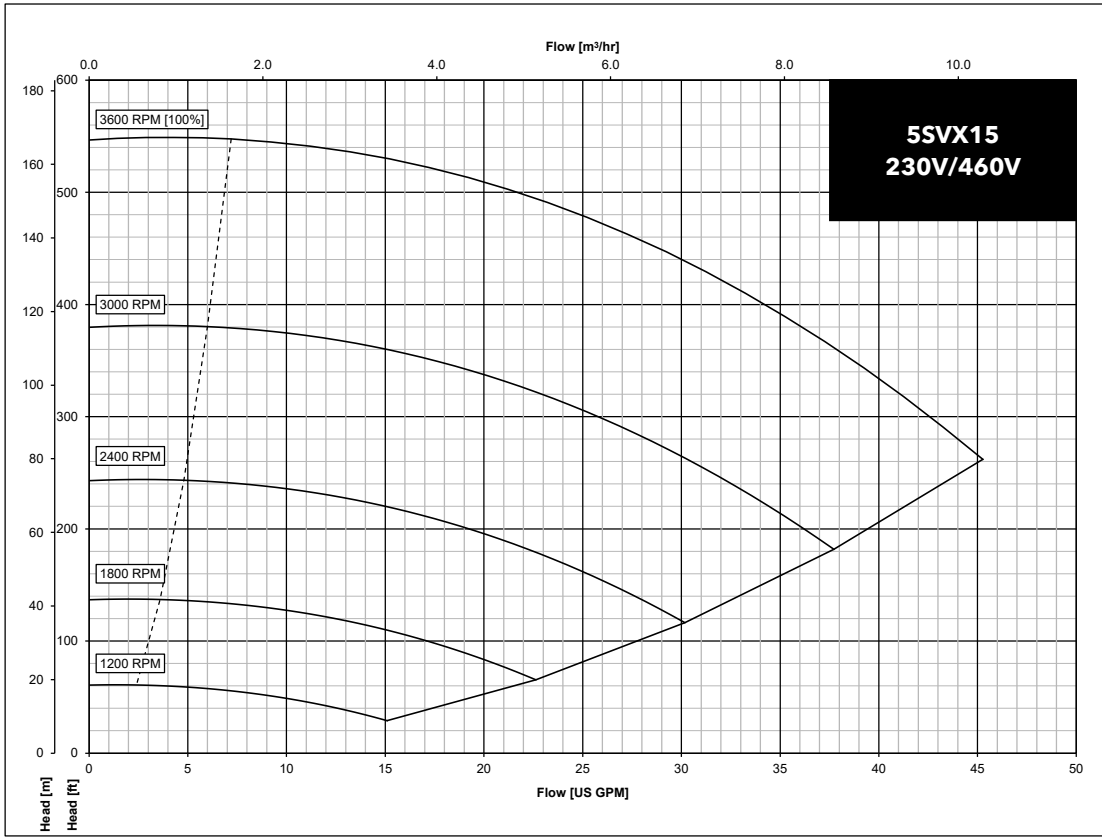

5SVX21 OPERATING CHARACTERISTICS

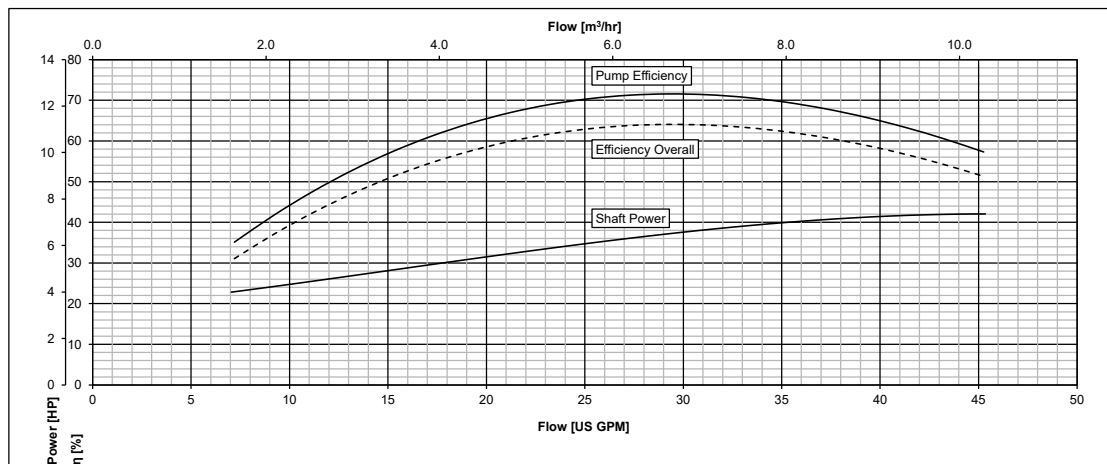
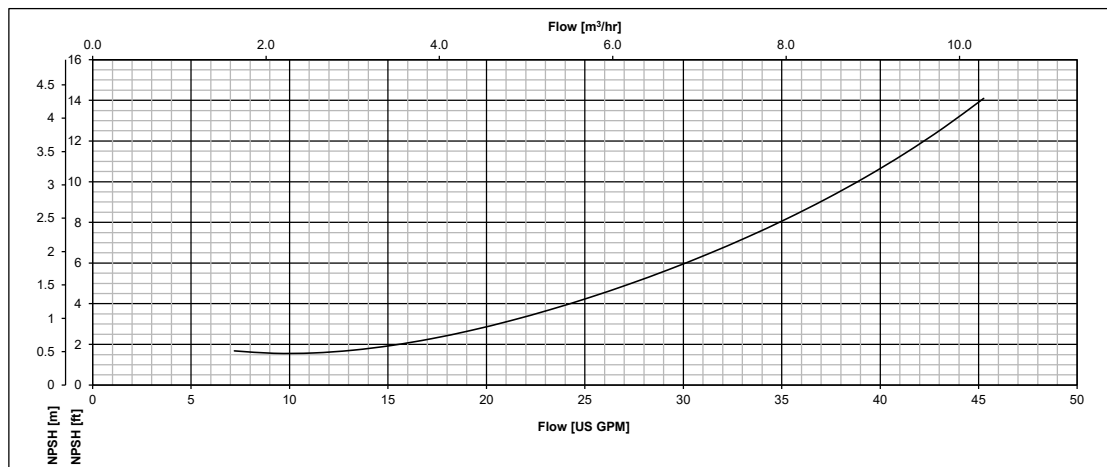
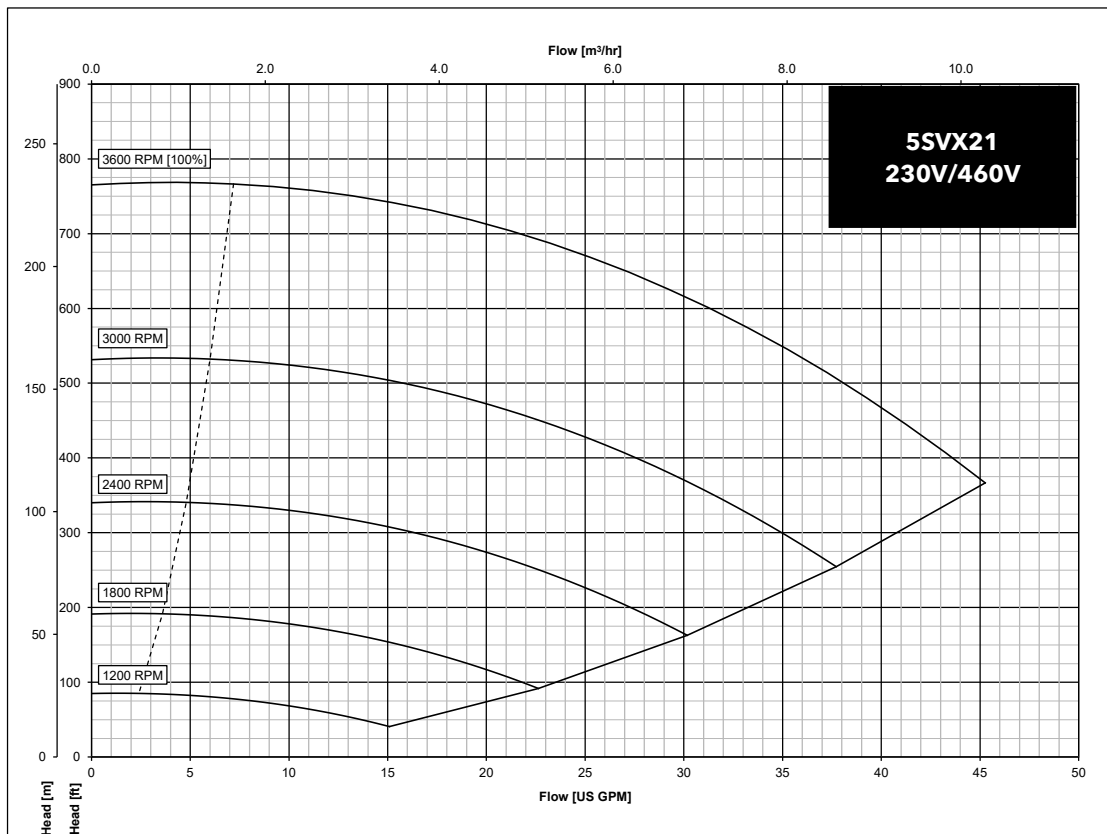

The performances are valid for liquid with density $\rho = 1.0 \text{ Kg/dm}^3$ and kinematic viscosity $\nu = 1 \text{ mm}^2/\text{sec}$.

5SVX27 OPERATING CHARACTERISTICS

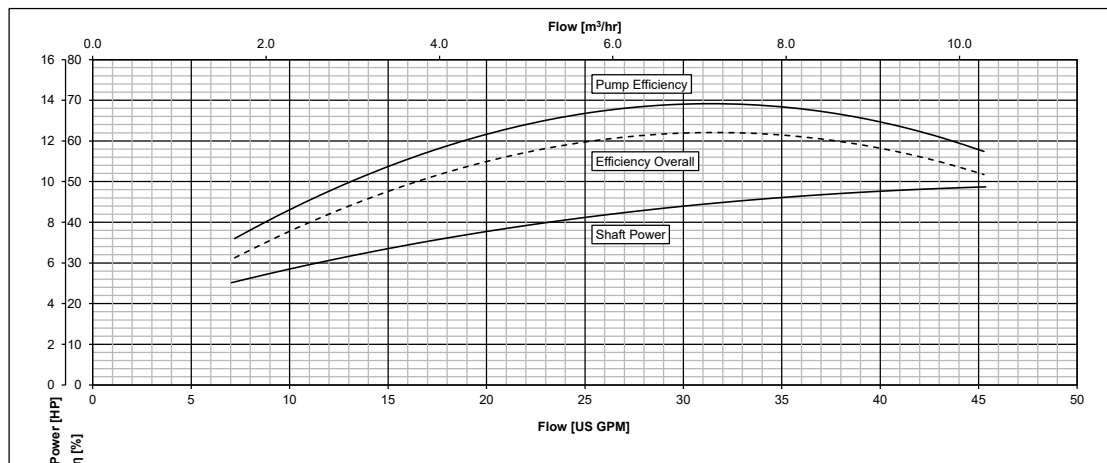
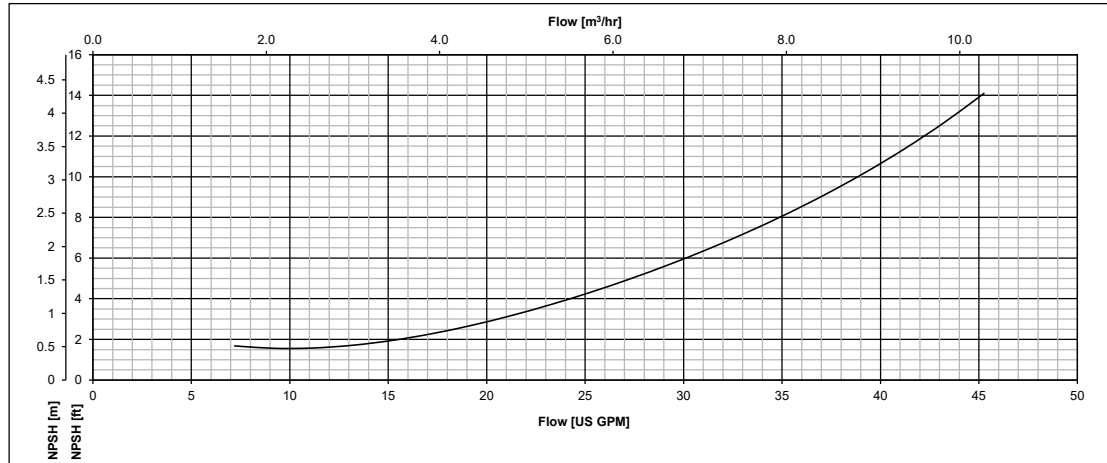
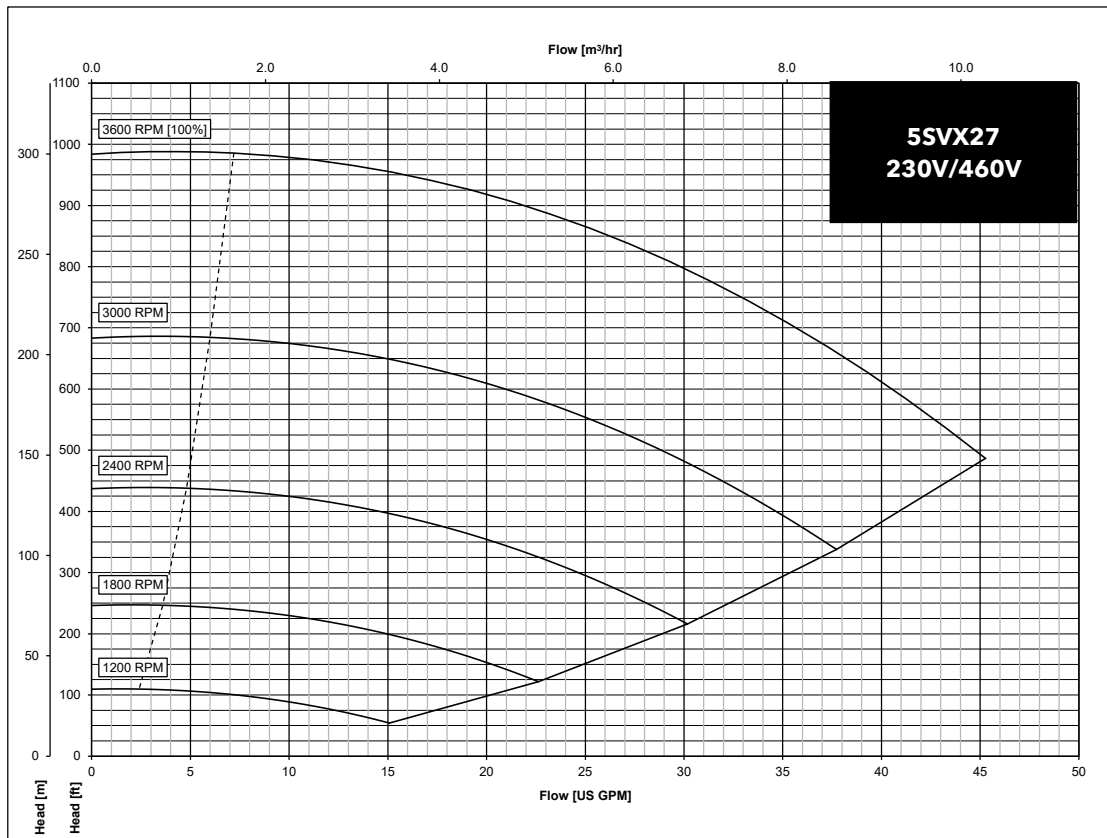

Commercial Water

10 SVX SERIES DIMENSIONS AND WEIGHTS

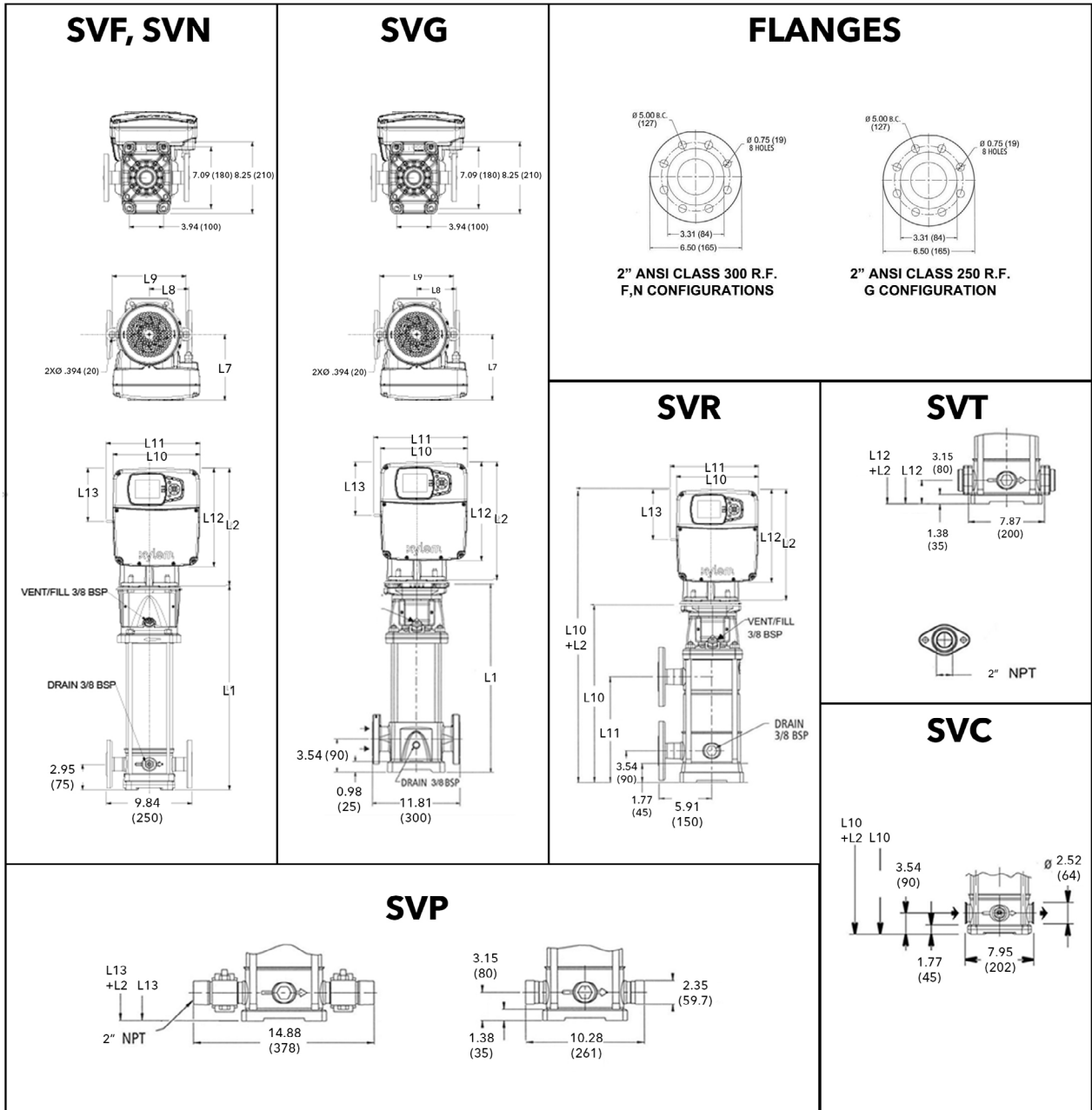

10SVX SERIES - 60 HZ, 3600 RPM TEFC ENCLOSURES

Pump Type Stages	Motor				Dimensions (in)													Weight (lbs.)		
	Voltage	HP	NEMA Frame	Motor Type	L1	L2	L3	L4	L5	L6	L7	L8	L9	L10	L11	L12	L13	Pump Only	Motor	Pump/Motor
			"TEFC 3Ø"																	
10SVX-04	380-480	4	143TC	EXM143-145TC/ 4.040BH2	19.58	13.53	10.078	10.828	11.359	6.148	7.618	4.531	8.504	-	-	19.19	19.19	46	45	91
	200-240	4	143TC	EXM143-145TC/ 3.040BH2	19.58	13.53	10.078	10.828	11.359	6.148	7.618	4.531	8.504	-	-	19.19	19.19	46	45	91
10SVX-05	380-480	5.5	143TC	EXM143-145TC/ 4.055BH2	20.84	13.53	10.078	10.828	11.359	6.148	7.618	4.531	8.504	20.84	10.2	20.45	20.45	48	47	95
	200-240	7.5	213TC	EXM213-215TC/ 3.075CH2	20.84	16.14	11.885	12.983	13.095	8.207	9.484	5.321	10.433	20.84	10.2	20.45	20.45	48	112	160
10SVX-08	380-480	7.5	143TC	EXM143-145TC/ 4.075BH2	24.62	13.53	10.078	10.828	11.359	6.148	7.618	4.531	8.504	24.62	13.98	24.22	24.22	54	55	109
	200-240	7.5	213TC	EXM213-215TC/ 3.075CH2	24.62	16.14	11.885	12.983	13.095	8.207	9.484	5.321	10.433	24.62	13.98	24.22	24.22	54	112	166
10SVX-10	380-480	10	213TC	EXM213-215TC/ 4.100CH2	27.71	16.14	11.885	12.983	13.095	8.207	9.484	5.321	10.433	27.71	16.5	-	27.31	66	97	163
	200-240	15	254TC	EXM254-256TC/ 3.150DH2	27.71	19.291	14.248	15.16	15.723	9.567	12.169	6.585	12.5	27.71	16.5	-	27.31	66	148	214
10SVX-16	380-480	15	213TC	EXM213-215TC/ 4.150CH2	35.92	16.14	11.885	12.983	13.095	8.207	9.484	5.321	10.433	-	-	-	35.52	86	112	198
	200-240	15	254TC	EXM254-256TC/ 3.150DH2	35.92	19.291	14.248	15.16	15.723	9.567	12.169	6.585	12.5	-	-	-	35.52	86	148	234
10SVX-20	380-480	20	254TC	EXM254-256TC/ 4.200DH2	40.96	19.291	14.248	15.16	15.723	9.567	12.169	6.585	12.5	-	-	-	40.56	94	161	255
	200-240	20	254TC	EXM254-256TC/ 3.200DH2	40.96	19.291	14.248	15.16	15.723	9.567	12.169	6.585	12.5	-	-	-	40.56	94	161	255

10SVX04 OPERATING CHARACTERISTICS

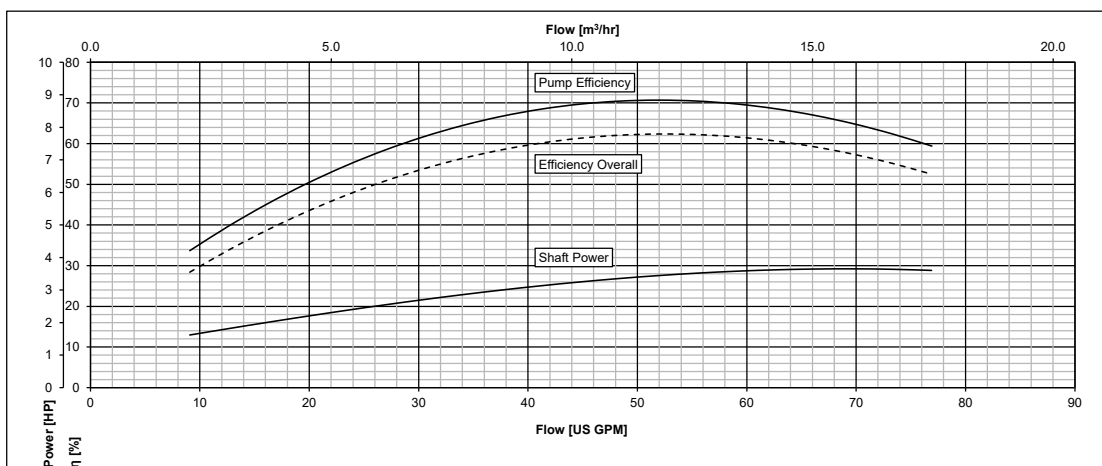
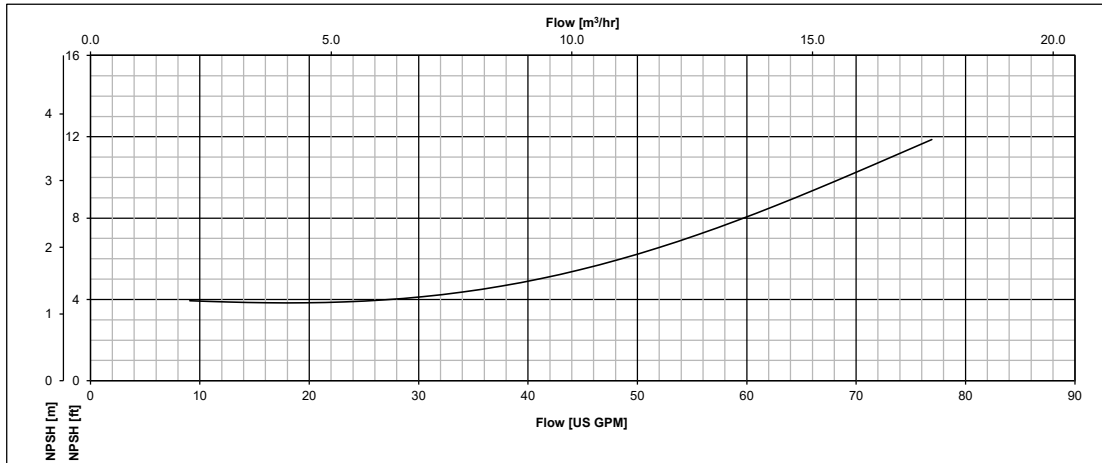
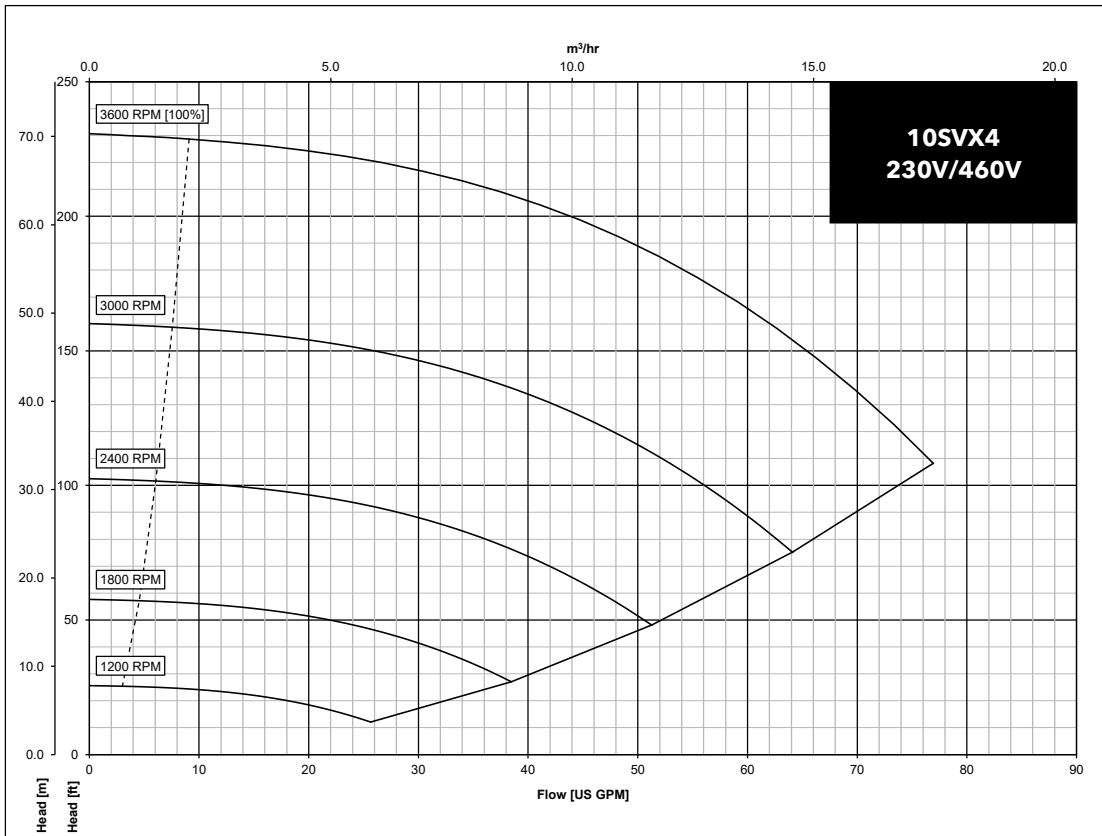

The performances are valid for liquid with density $\rho = 1.0 \text{ Kg/dm}^3$ and kinematic viscosity $\nu = 1 \text{ mm}^2/\text{sec}$.

10SVX05 OPERATING CHARACTERISTICS

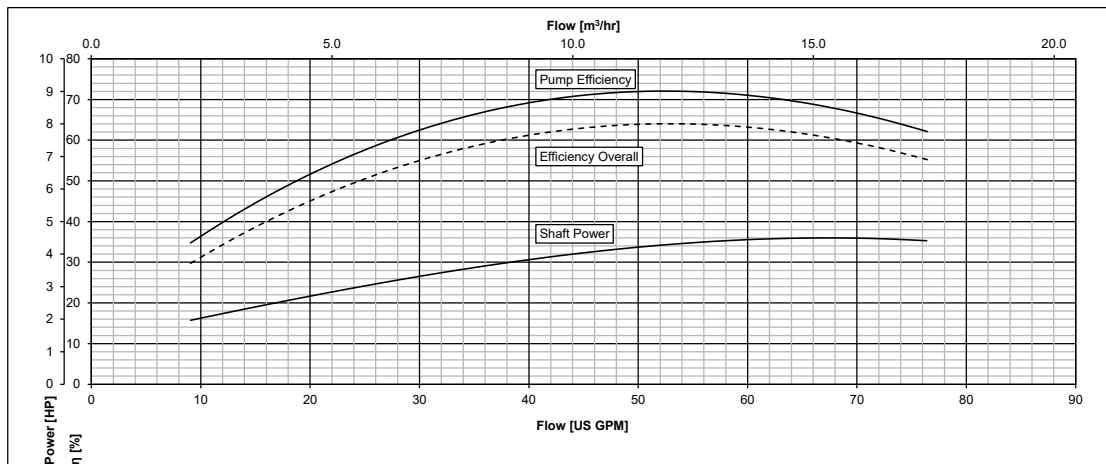
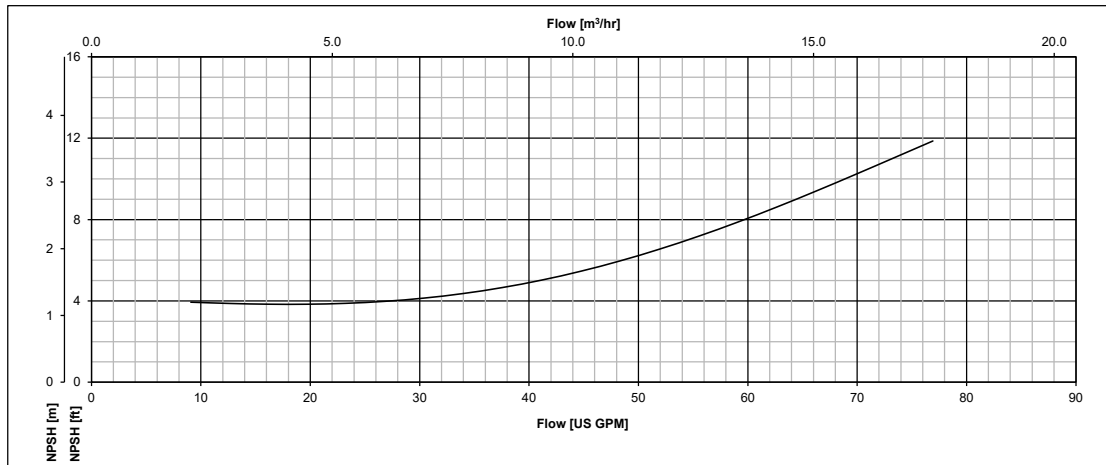
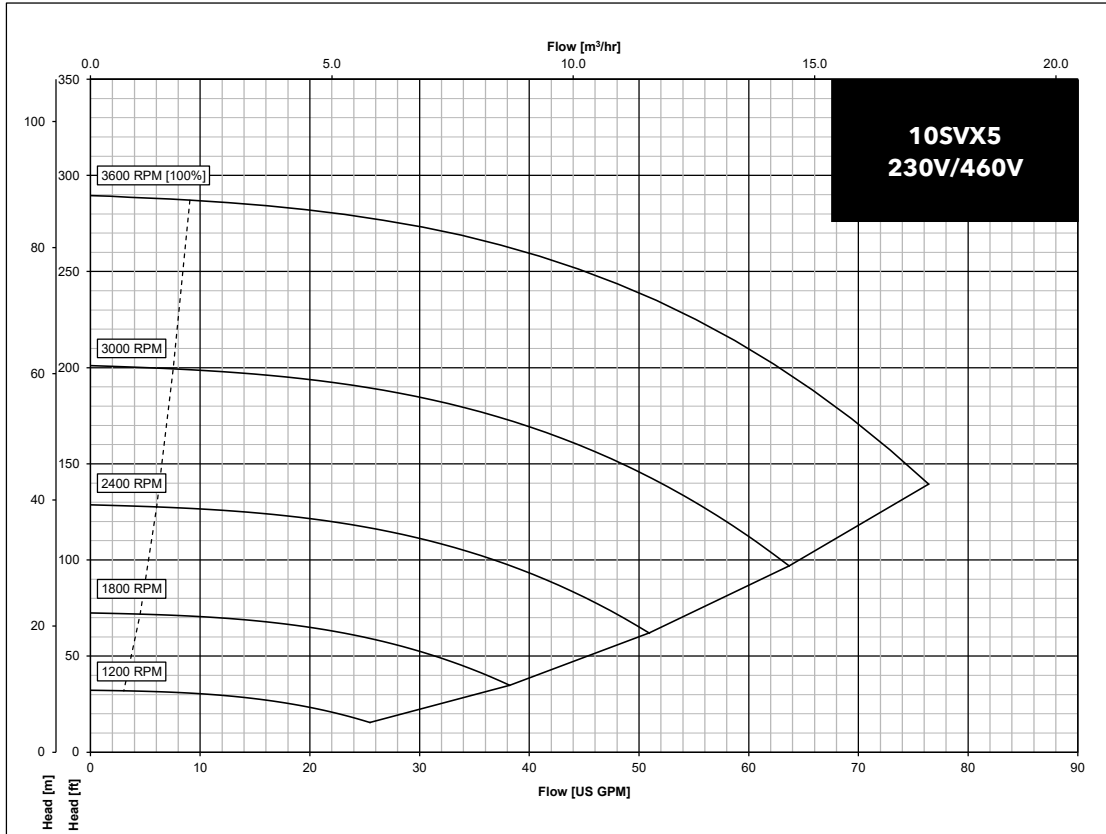

10SVX08 OPERATING CHARACTERISTICS

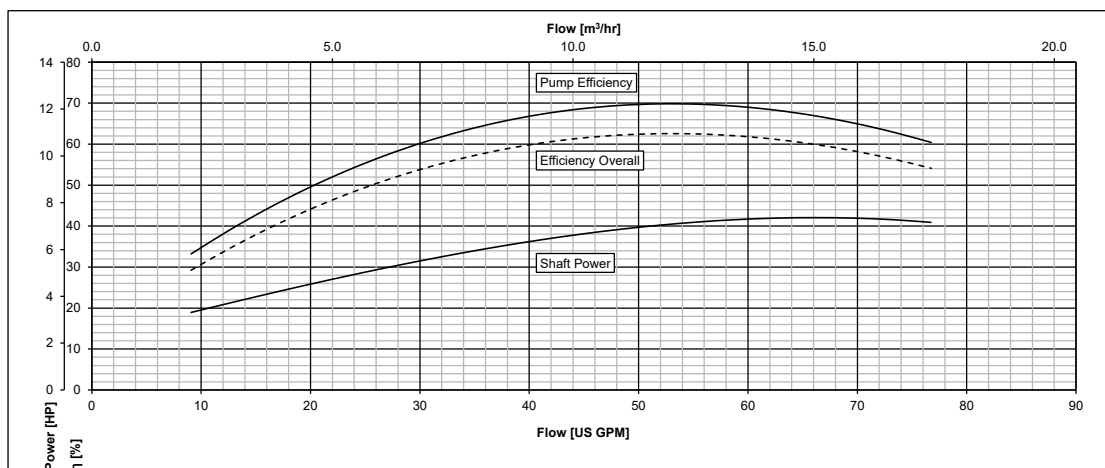
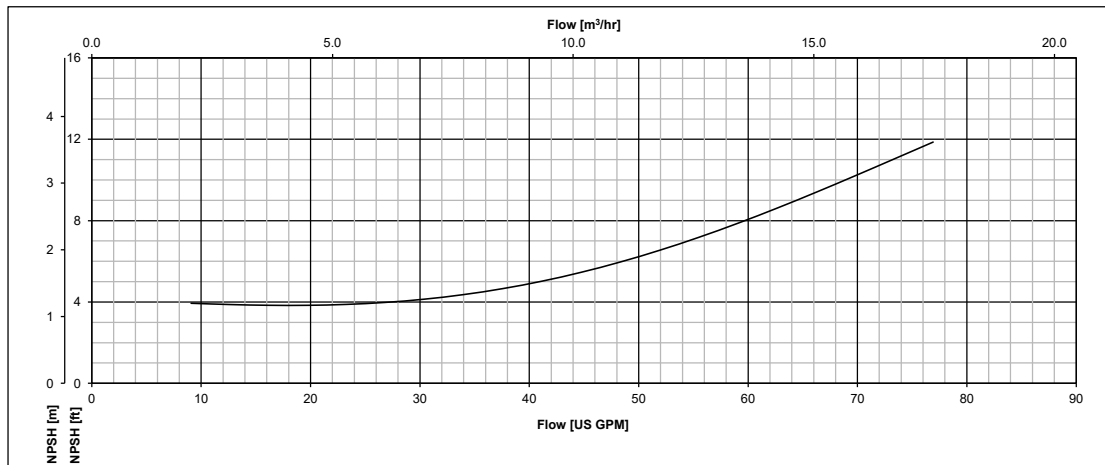
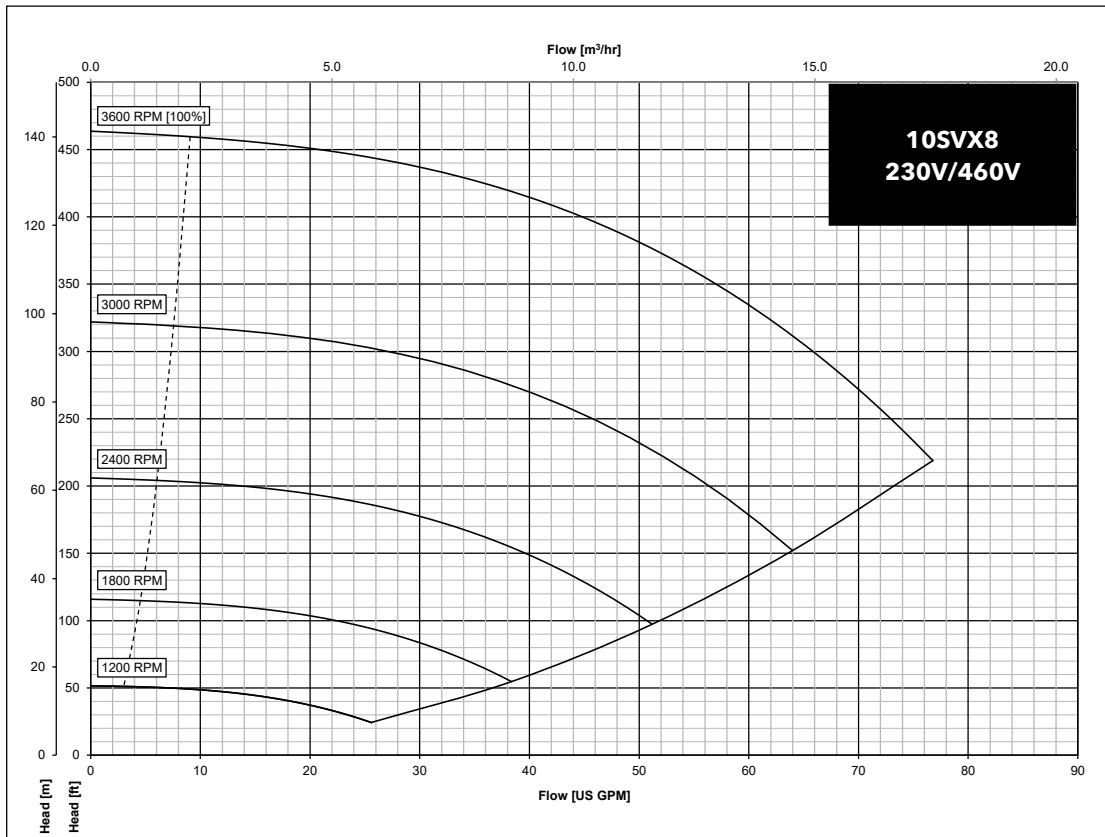

The performances are valid for liquid with density $\rho = 1.0 \text{ Kg/dm}^3$ and kinematic viscosity $\nu = 1 \text{ mm}^2/\text{sec}$.

10SVX10 OPERATING CHARACTERISTICS

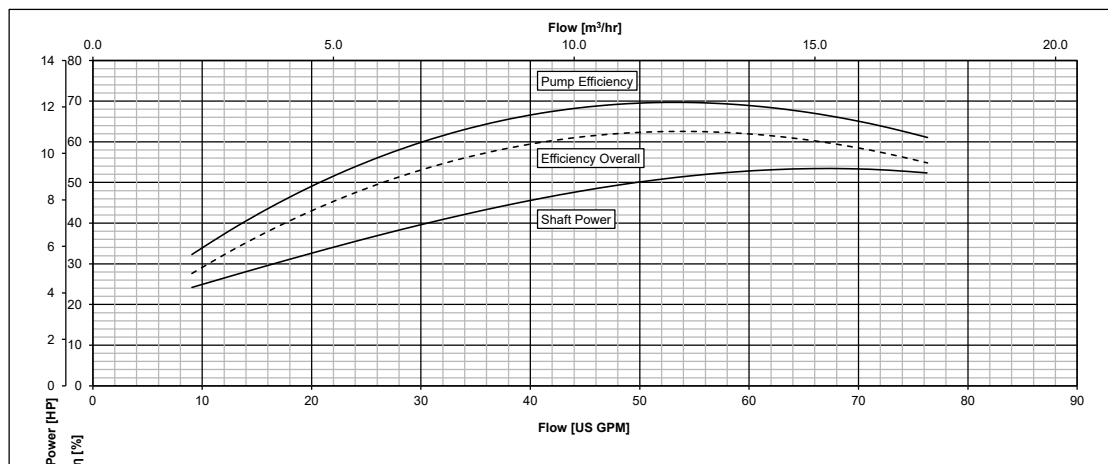
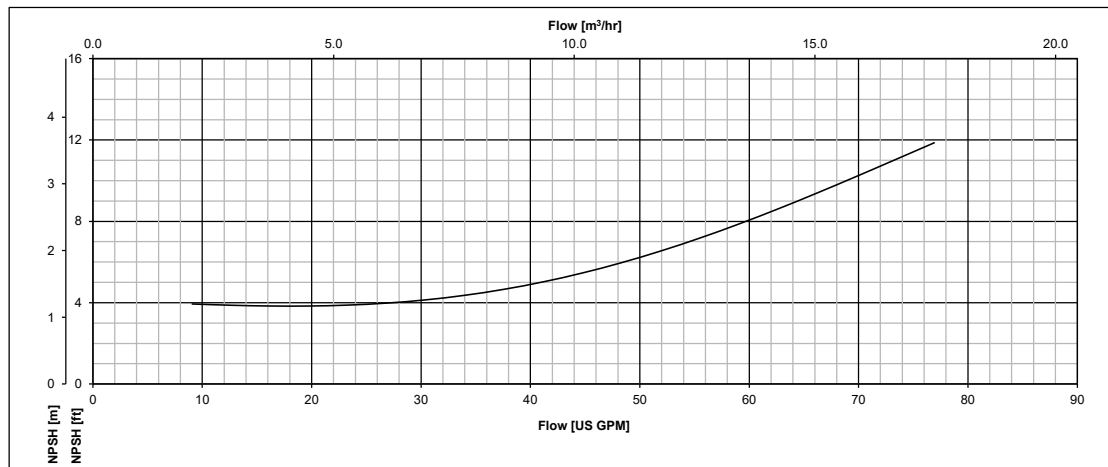
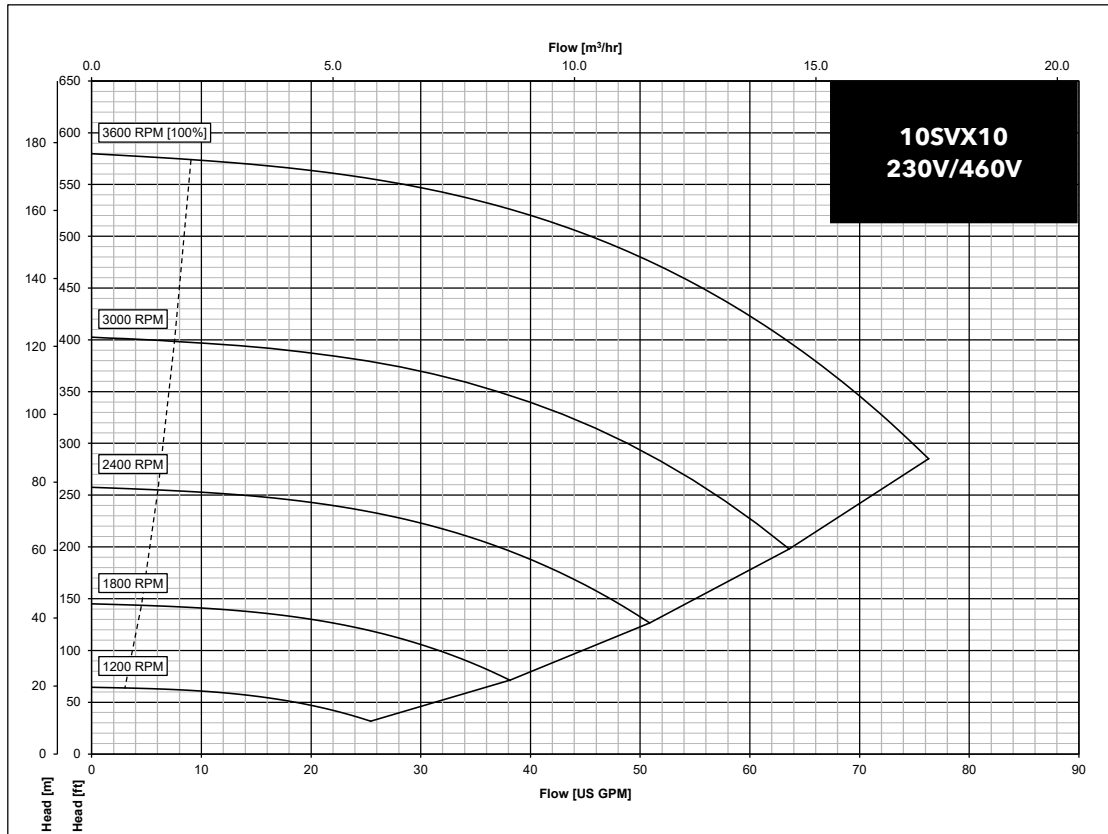

10SVX16 OPERATING CHARACTERISTICS

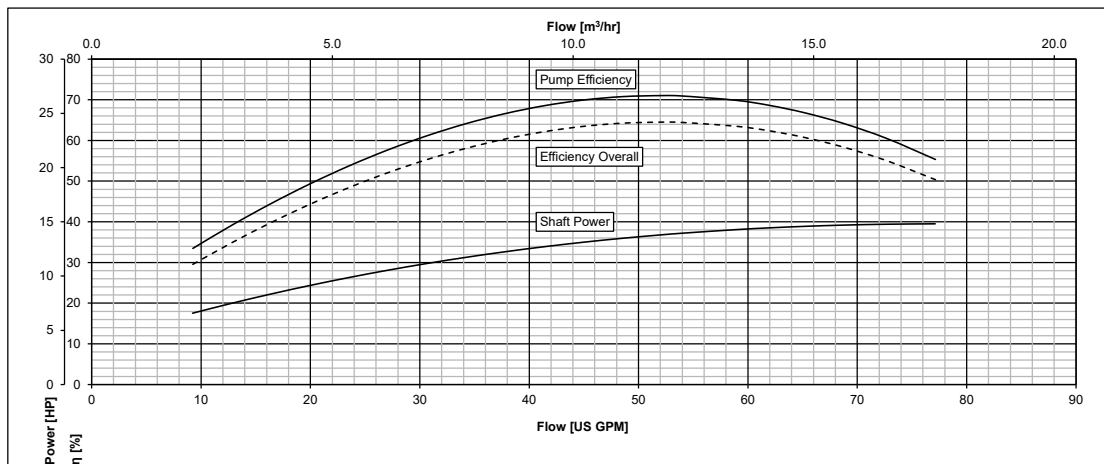
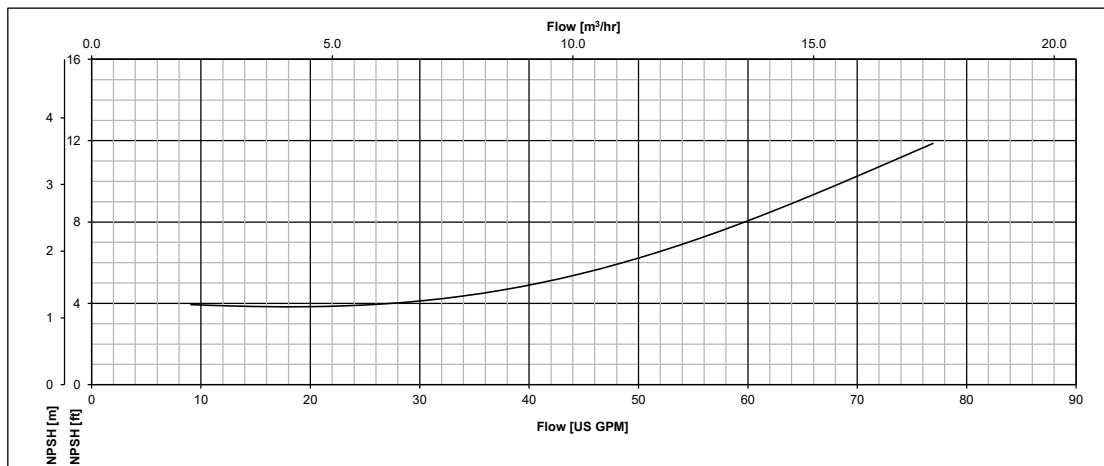
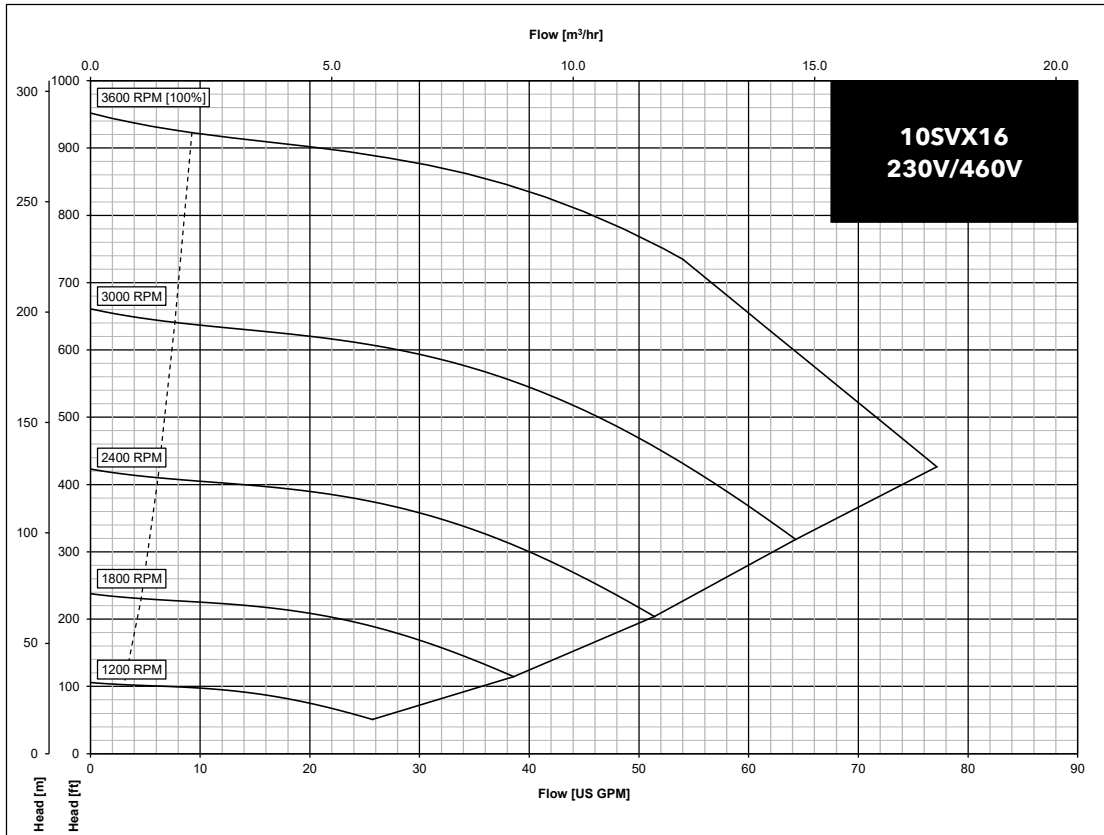

The performances are valid for liquid with density $\rho = 1.0 \text{ Kg/dm}^3$ and kinematic viscosity $\nu = 1 \text{ mm}^2/\text{sec}$.

10SVX20 OPERATING CHARACTERISTICS

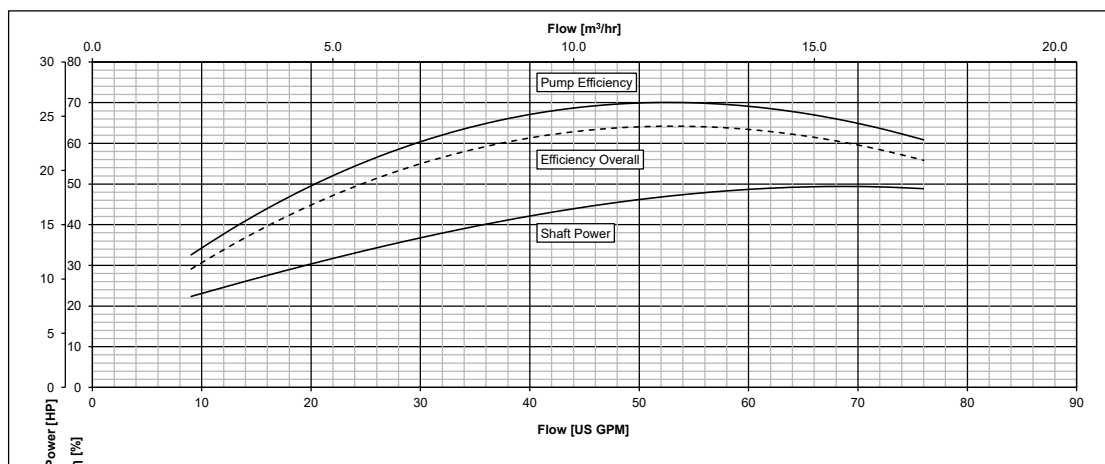
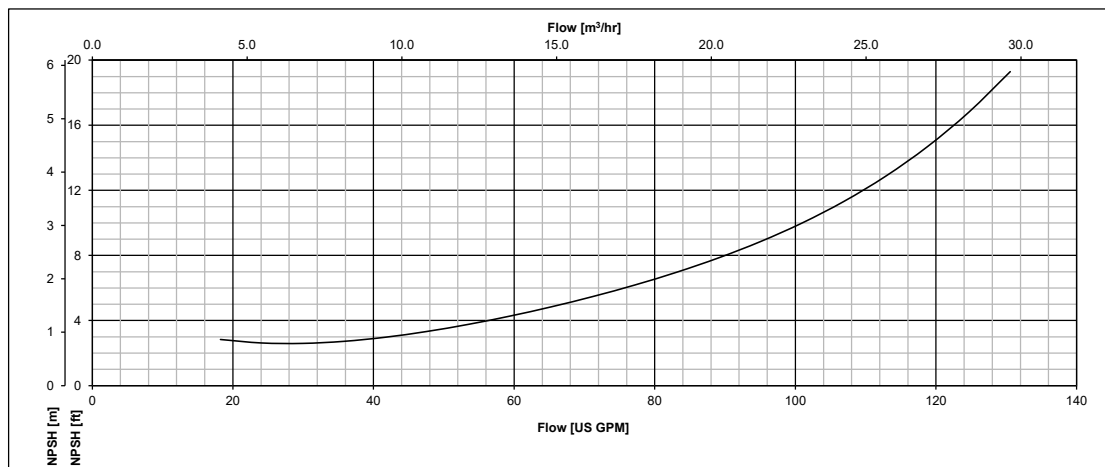
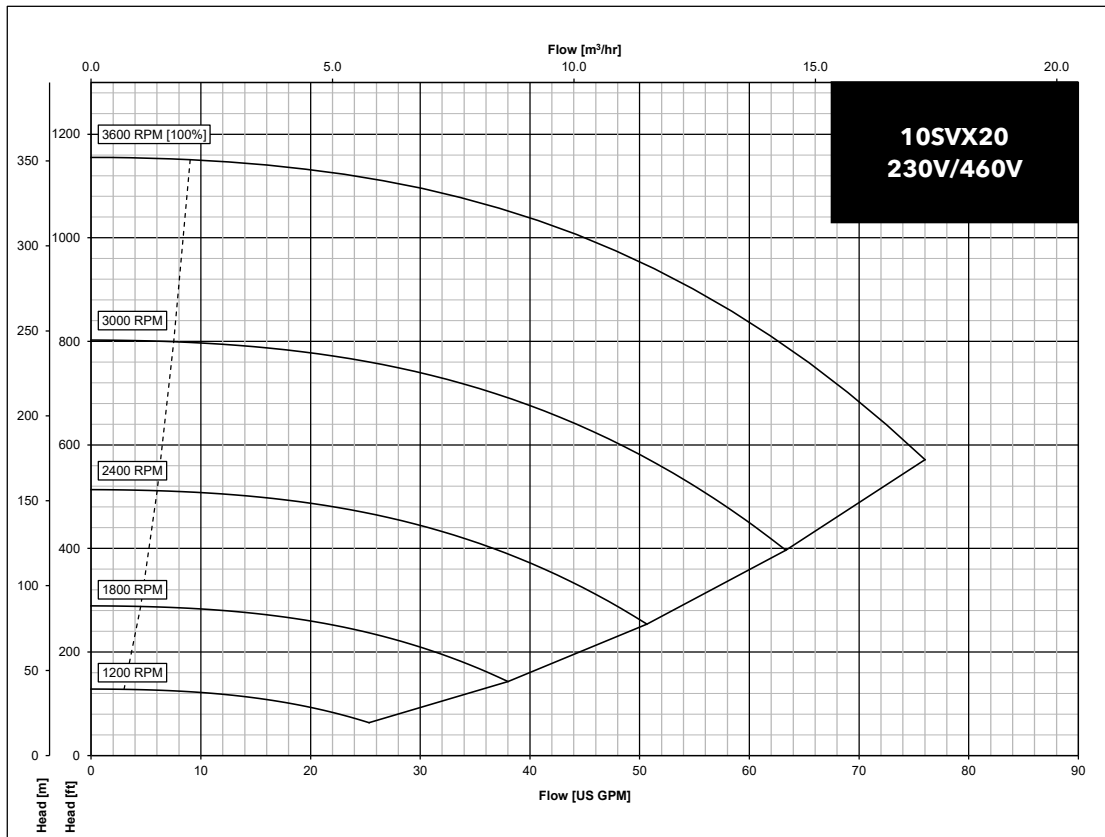

Commercial Water

15 SVX SERIES DIMENSIONS AND WEIGHTS

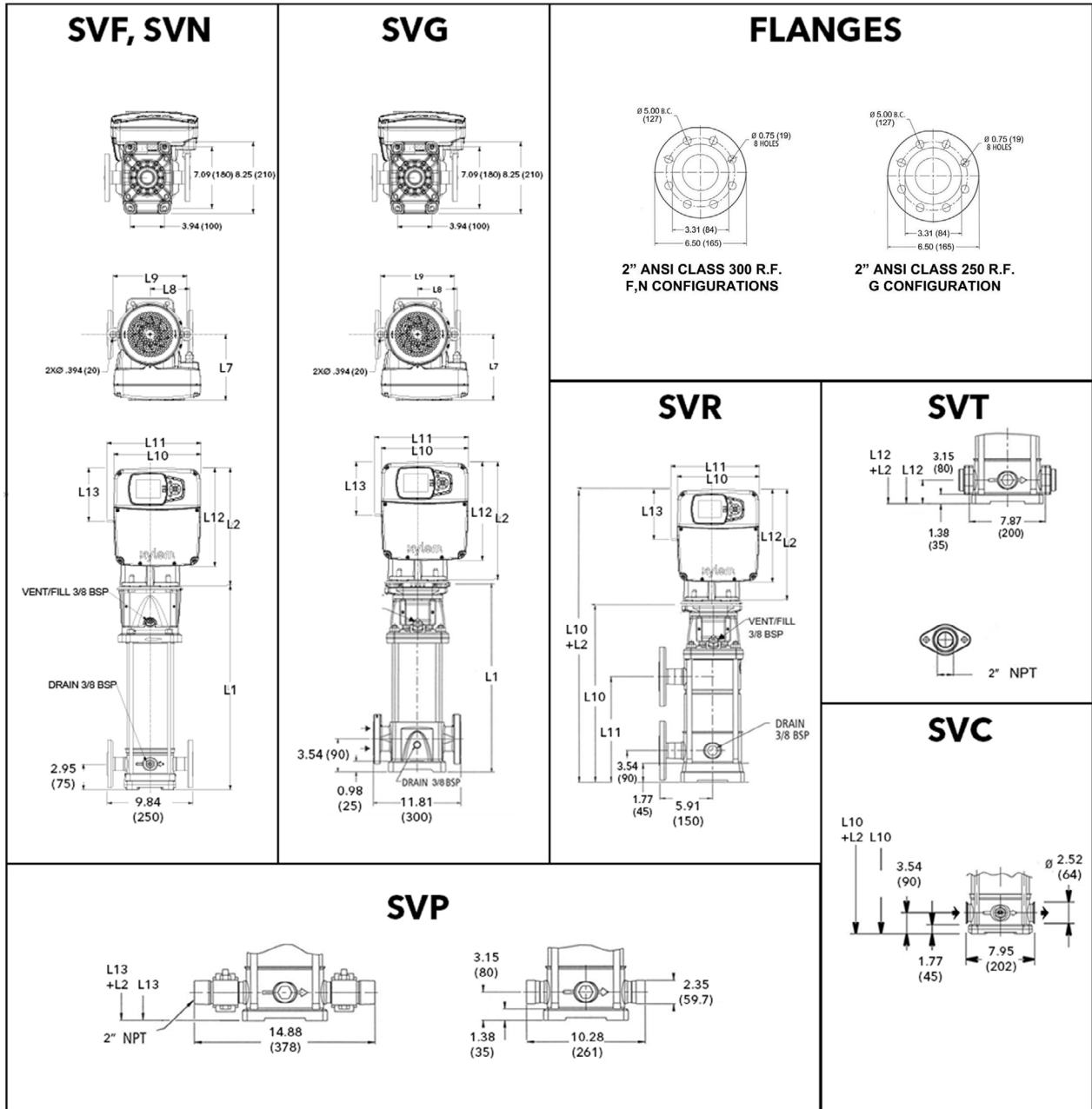

15SVX SERIES - 60 HZ, 3600 RPM TEFC ENCLOSURES

Pump Type Stages	Motor				Dimensions (in)													Weight (lbs.)		
	Voltage	HP	NEMA Frame	Motor Type	L1	L2	L3	L4	L5	L6	L7	L8	L9	L10	L11	L12	L13	Pump Only	Motor	Pump/Motor
			TEFC 3Ø																	
15SVX-02	380-480	5.5	143TC	EXM143-145TC/4.055BH2	18.71	13.53	10.08	10.83	11.36	6.15	7.62	4.53	8.50	-	-	18.32	18.32	44	47	91
	200-240	7.5	213TC	EXM213-215TC/3.075CH2	18.71	16.14	11.885	12.983	13.095	8.207	9.484	5.321	10.433	-	-	18.32	18.32	44	112	156
15SVX-03	380-480	7.5	143TC	EXM143-145TC/4.075BH2	20.60	13.53	10.08	10.83	11.36	6.15	7.62	4.53	8.50	-	-	20.21	20.21	47	55	102
	200-240	7.5	213TC	EXM213-215TC/3.075CH2	20.60	16.14	11.885	12.983	13.095	8.207	9.484	5.321	10.433	-	-	20.21	20.21	47	112	159
15SVX-04	380-480	10	213TC	EXM213-215TC/4.100CH2	22.49	16.14	11.89	12.98	13.10	8.21	9.48	5.32	10.43	22.49	11.85	22.10	22.10	50	97	147
	200-240	15	254TC	EXM254-256TC/3.150DH2	22.49	19.291	14.248	15.16	15.723	9.567	12.169	6.585	12.5	22.49	11.85	22.10	22.10	50	148	198
15SVX-07	380-480	15	213TC	EXM213-215TC/4.150CH2	29.38	16.14	11.89	12.98	13.10	8.21	9.48	5.32	10.43	29.38	17.52	28.99	28.99	74	112	186
	200-240	15	254TC	EXM254-256TC/3.150DH2	29.38	19.291	14.248	15.16	15.723	9.567	12.169	6.585	12.5	29.38	17.52	28.99	28.99	74	148	222
15SVX-09	380-480	20	254TC	EXM254-256TC/4.200DH2	33.16	19.29	14.25	15.16	15.72	9.57	12.17	6.59	12.50	33.16	21.30	-	32.77	79	161	240
	200-240	20	254TC	EXM254-256TC/3.200DH2	33.16	19.29	14.25	15.16	15.72	9.57	12.17	6.59	12.50	33.16	21.30	-	32.77	79	161	240
15SVX-12	380-480	25	254TC	EXM254-256TC/4.250DH2	38.83	19.29	14.25	15.16	15.72	9.57	12.17	6.59	12.50	-	-	-	38.44	89	174	263
15SVX-14	380-480	30	254TC	EXM254-256TC/4.300DH2	43.24	19.29	14.25	15.16	15.72	9.57	12.17	6.59	12.50	-	-	-	42.85	103	187	290

15SVX02 OPERATING CHARACTERISTICS

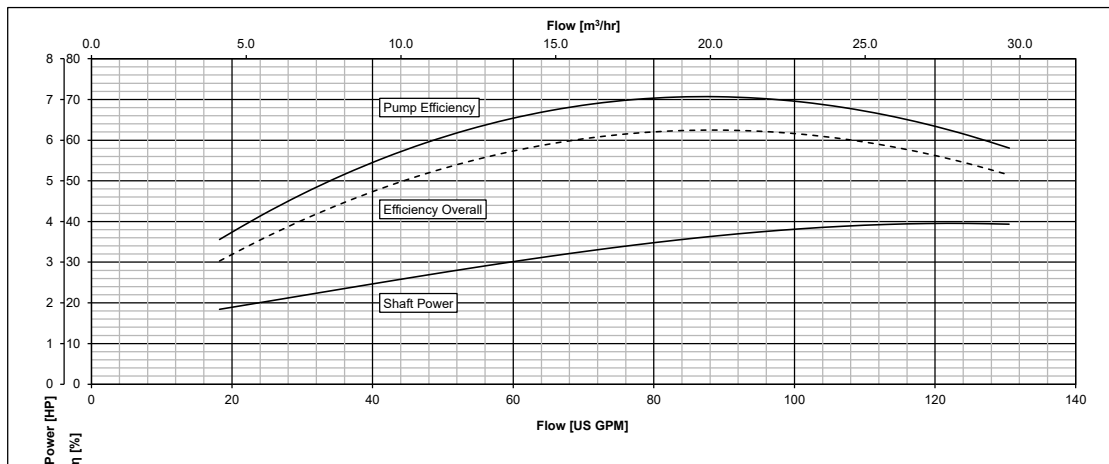
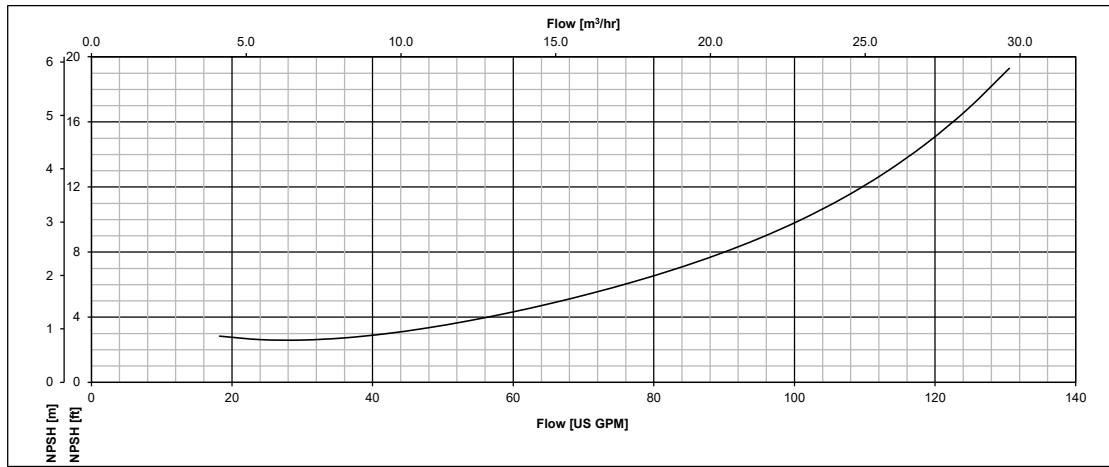
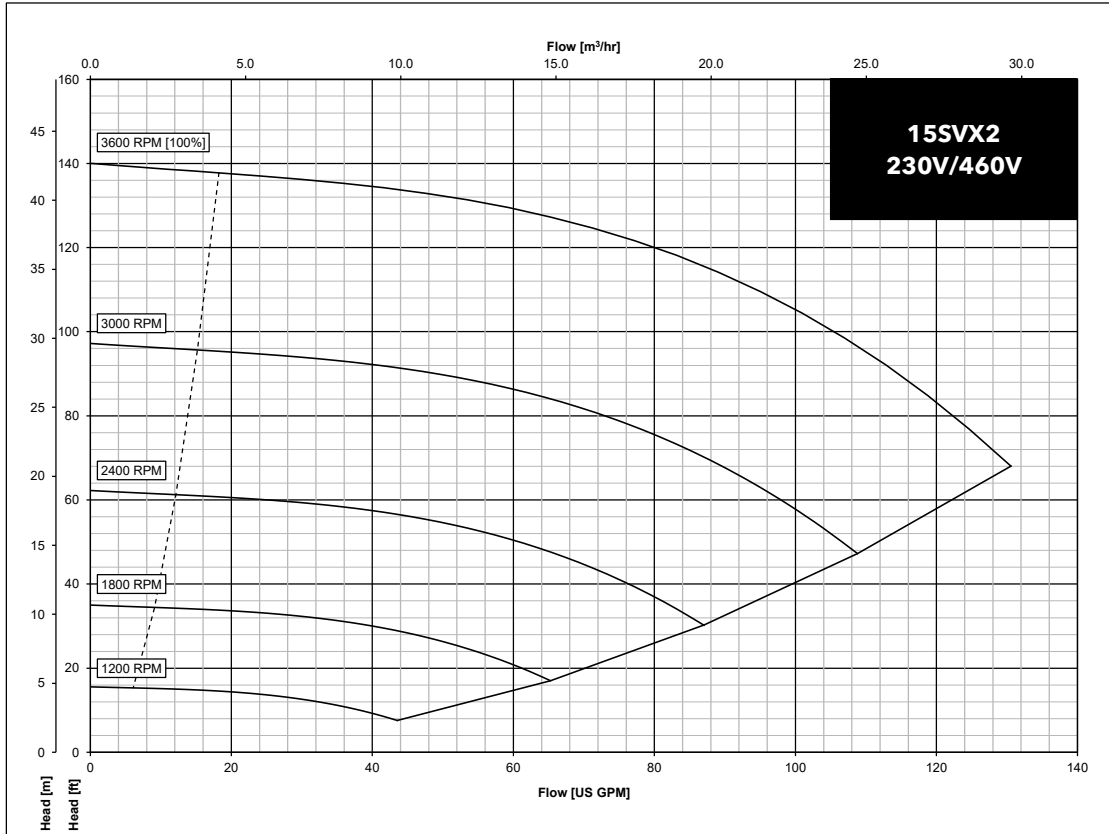

The performances are valid for liquid with density $\rho = 1.0 \text{ Kg/dm}^3$ and kinematic viscosity $\nu = 1 \text{ mm}^2/\text{sec}$.

15SVX03 OPERATING CHARACTERISTICS

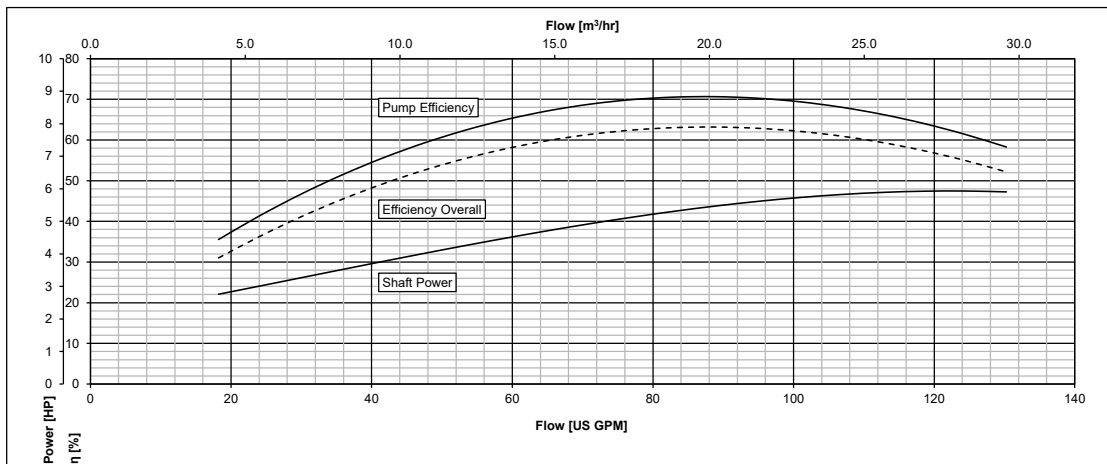
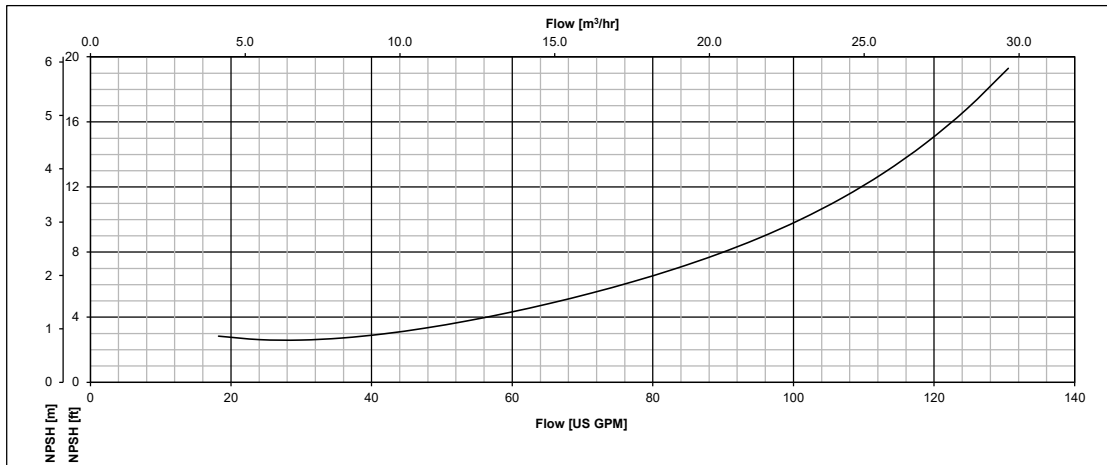
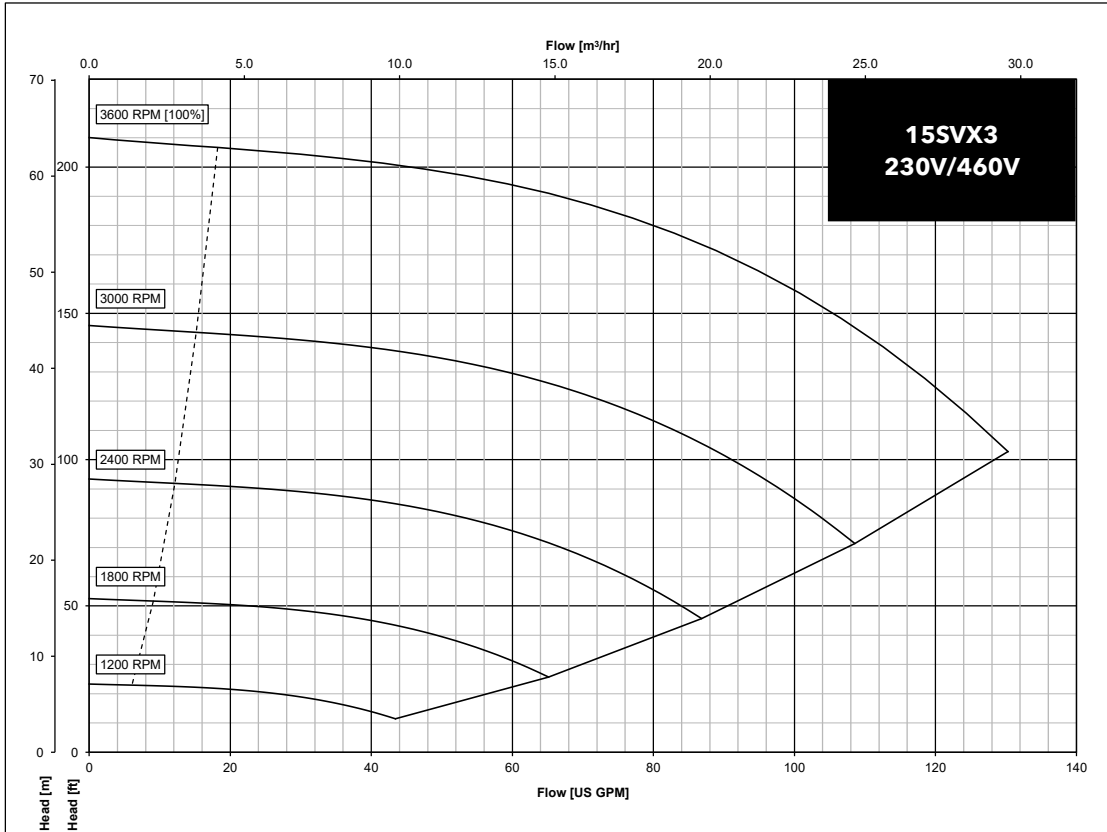

Commercial Water

15SVX04 OPERATING CHARACTERISTICS

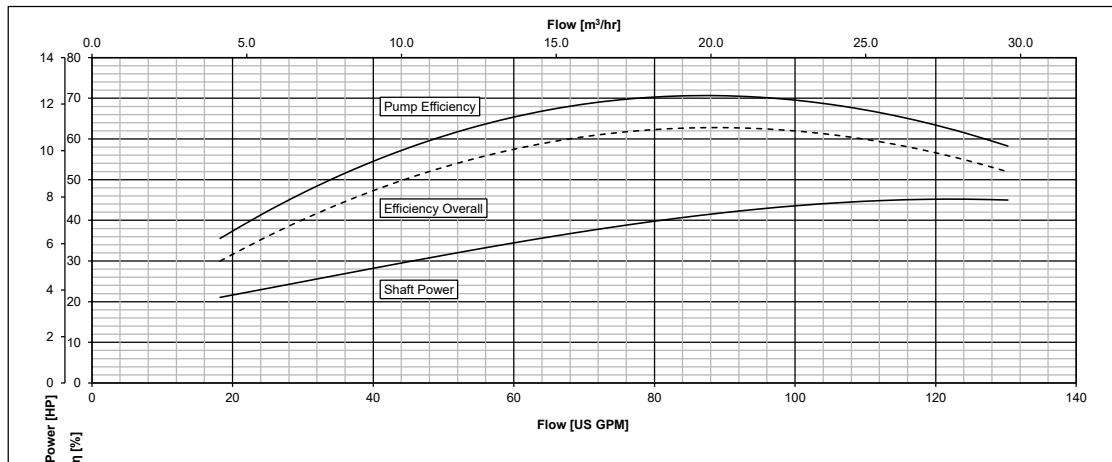
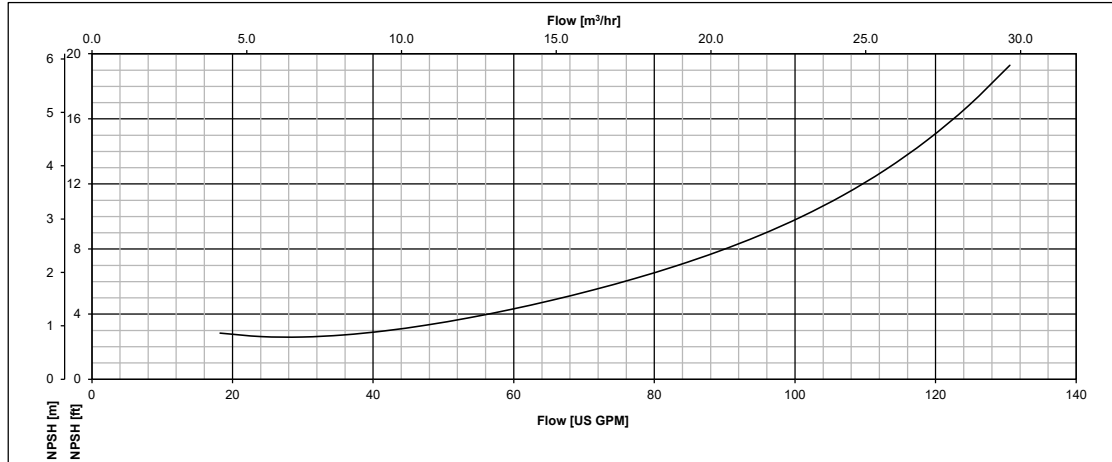
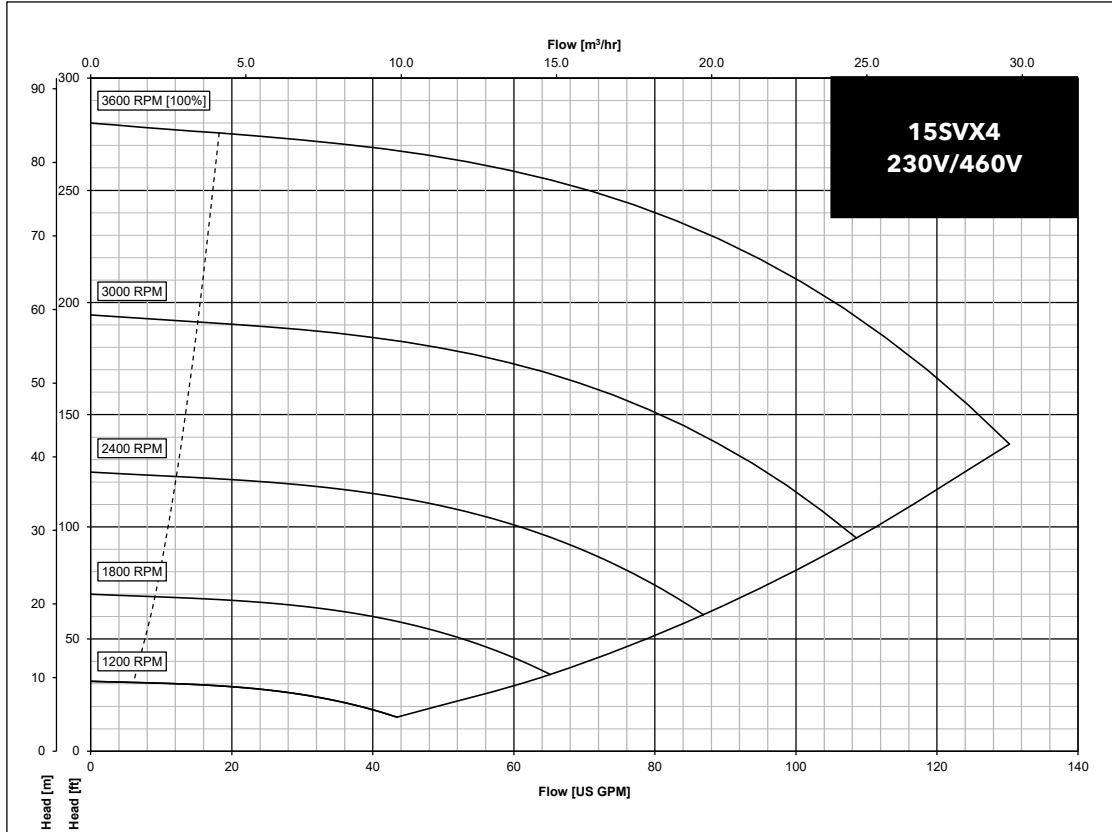

The performances are valid for liquid with density $\rho = 1.0 \text{ Kg/dm}^3$ and kinematic viscosity $\nu = 1 \text{ mm}^2/\text{sec}$.

15SVX07 OPERATING CHARACTERISTICS

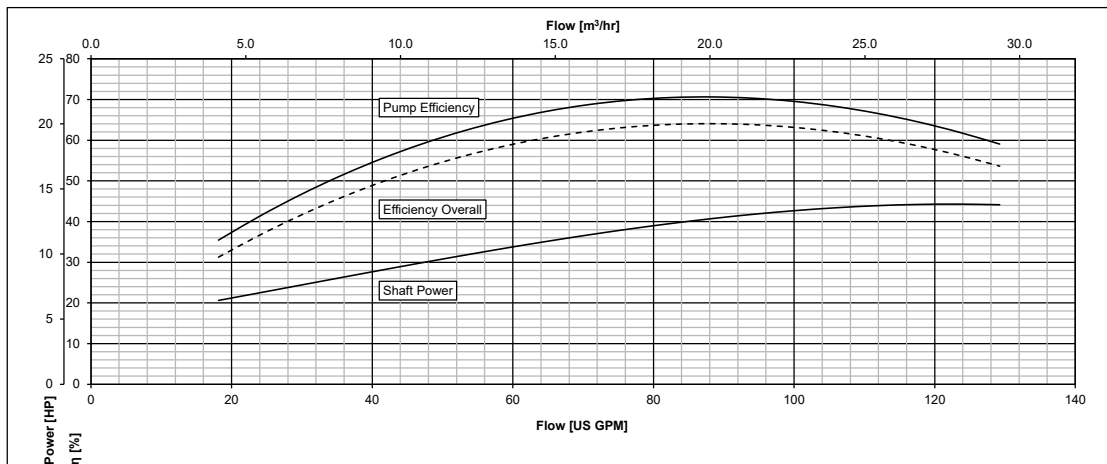
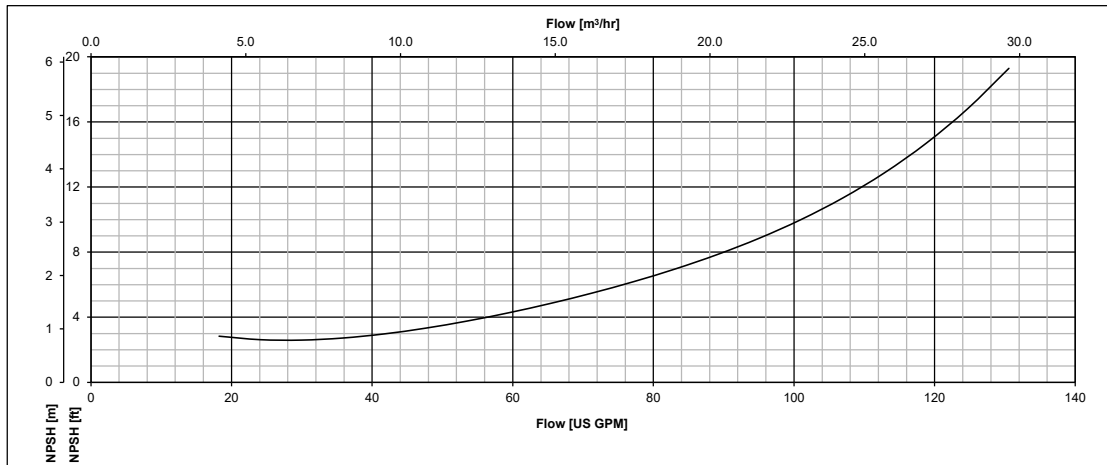
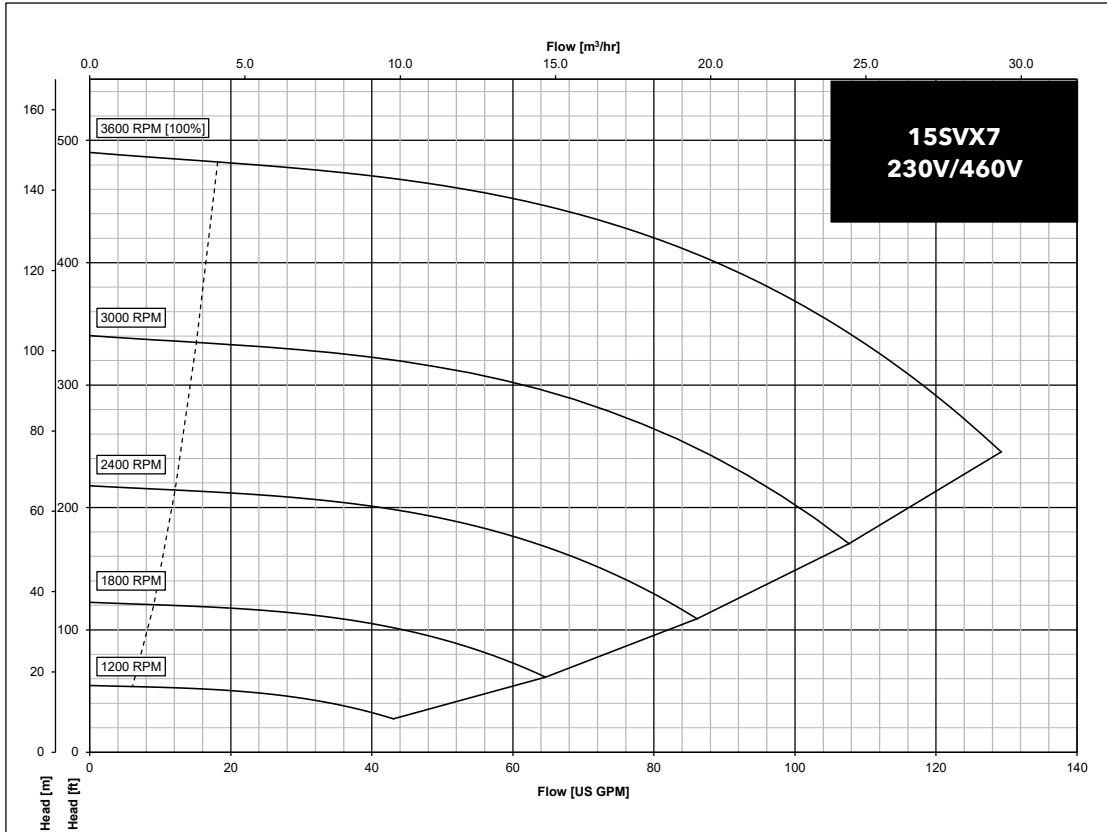

15SVX09 OPERATING CHARACTERISTICS

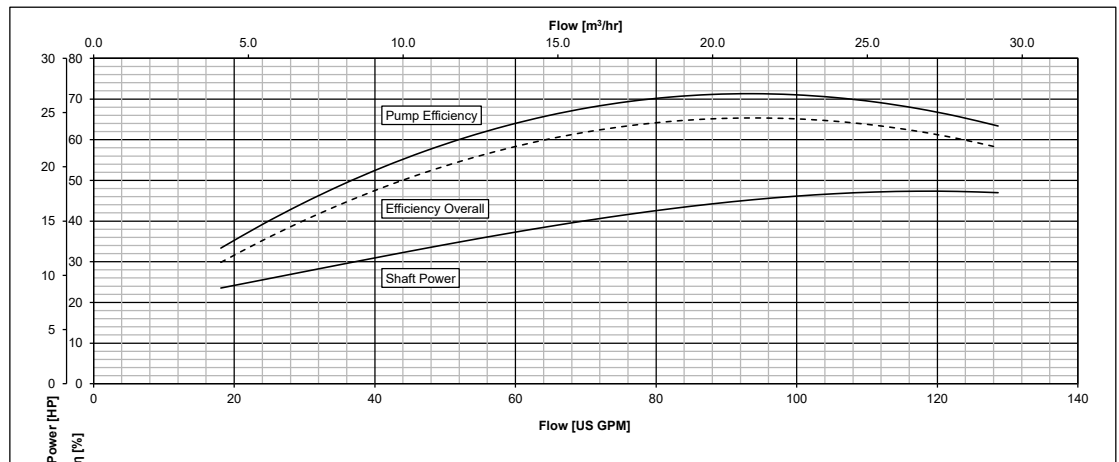
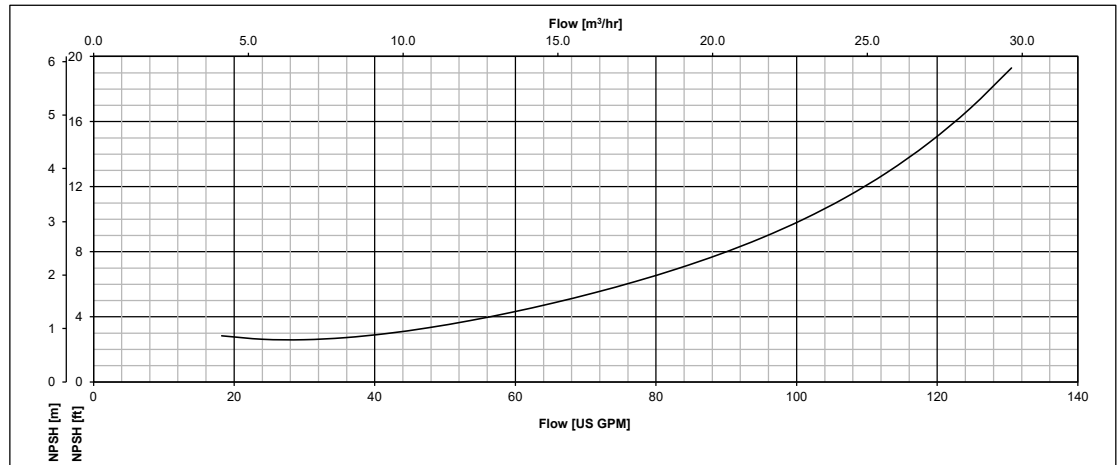
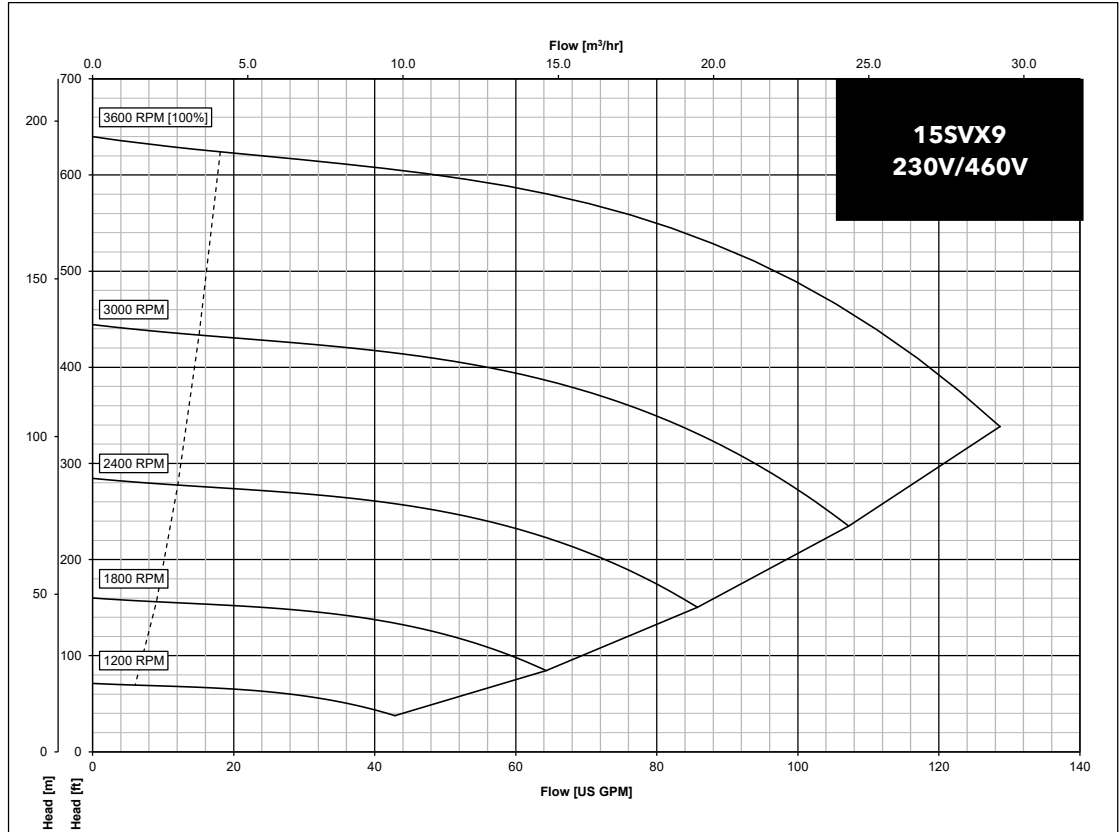

The performances are valid for liquid with density $\rho = 1.0 \text{ Kg/dm}^3$ and kinematic viscosity $\nu = 1 \text{ mm}^2/\text{sec}$.

15SVX12 SERIES OPERATING CHARACTERISTICS

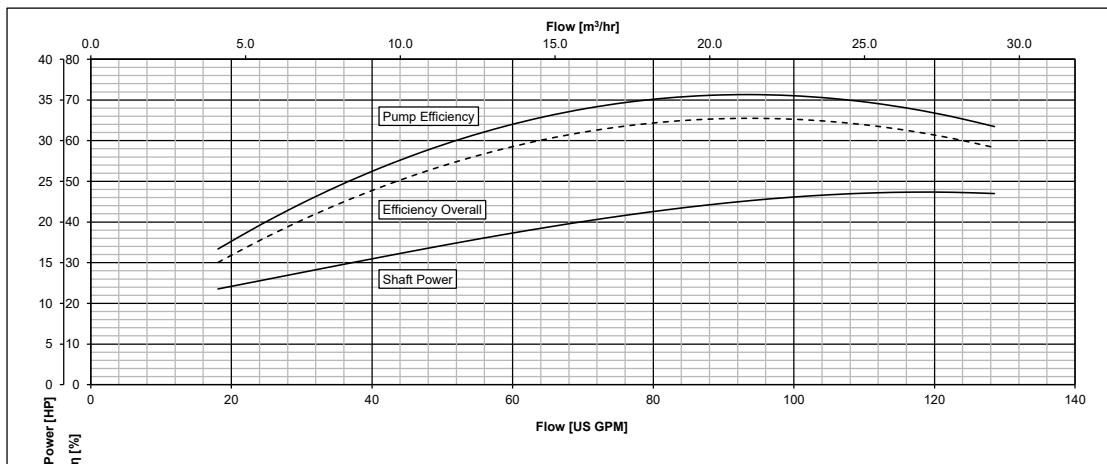
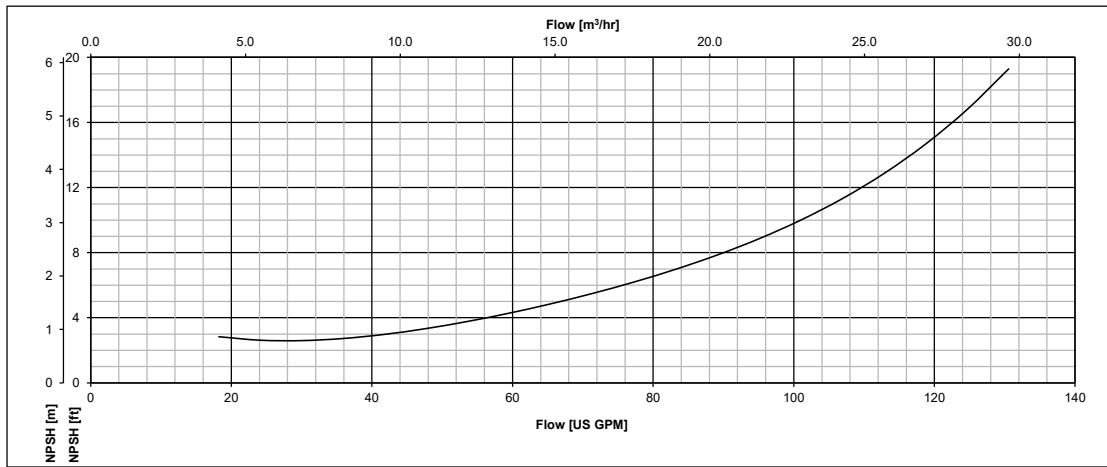
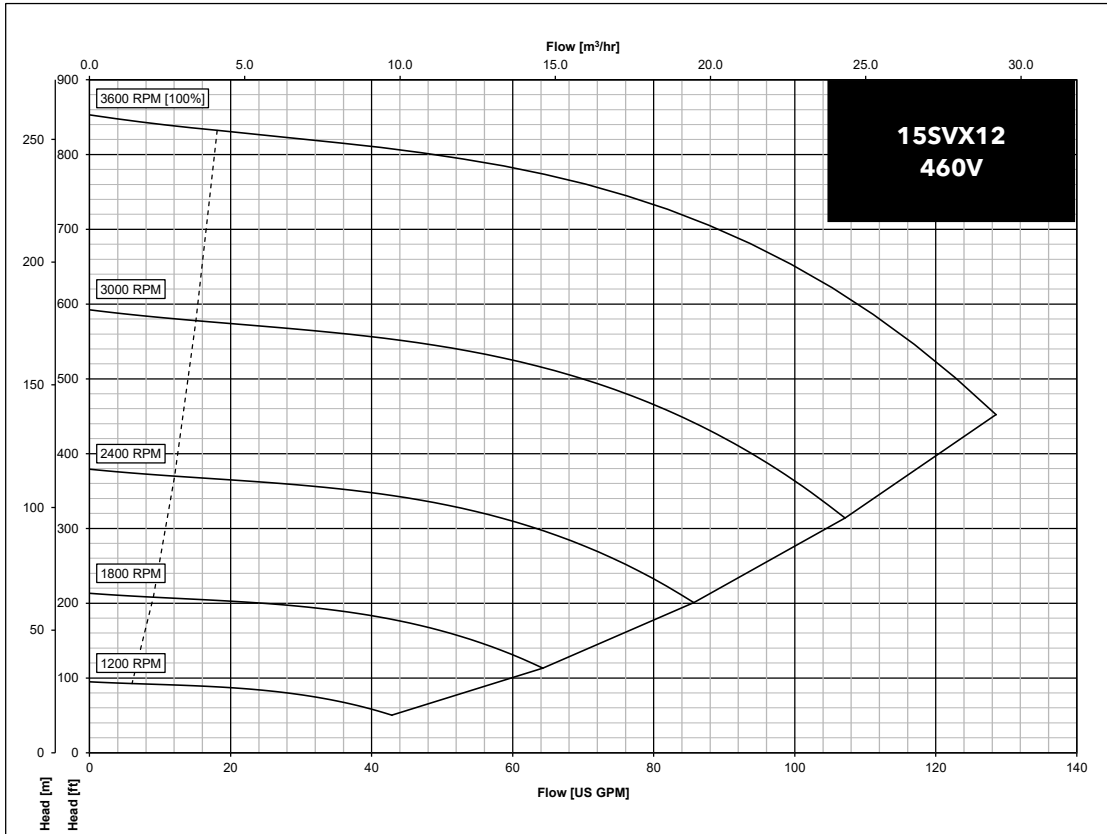

15SVX14 SERIES OPERATING CHARACTERISTICS

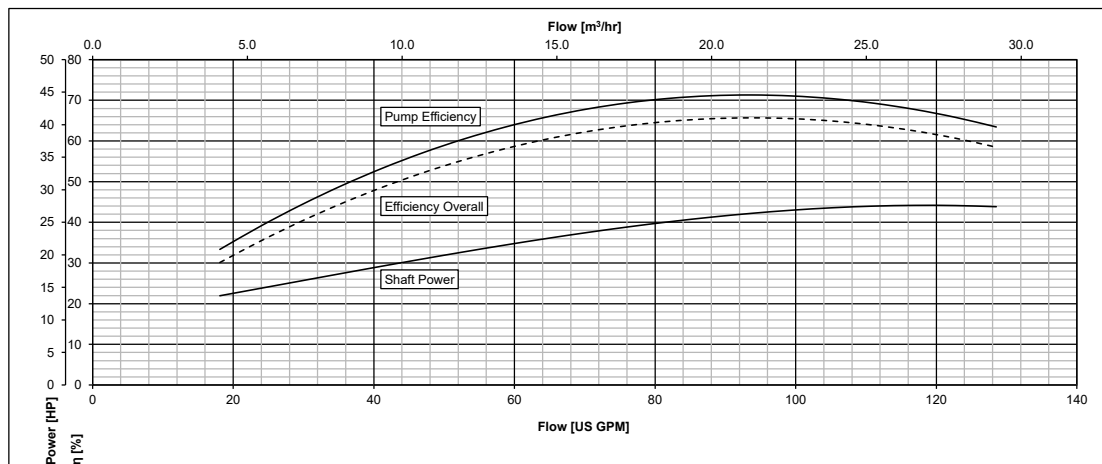
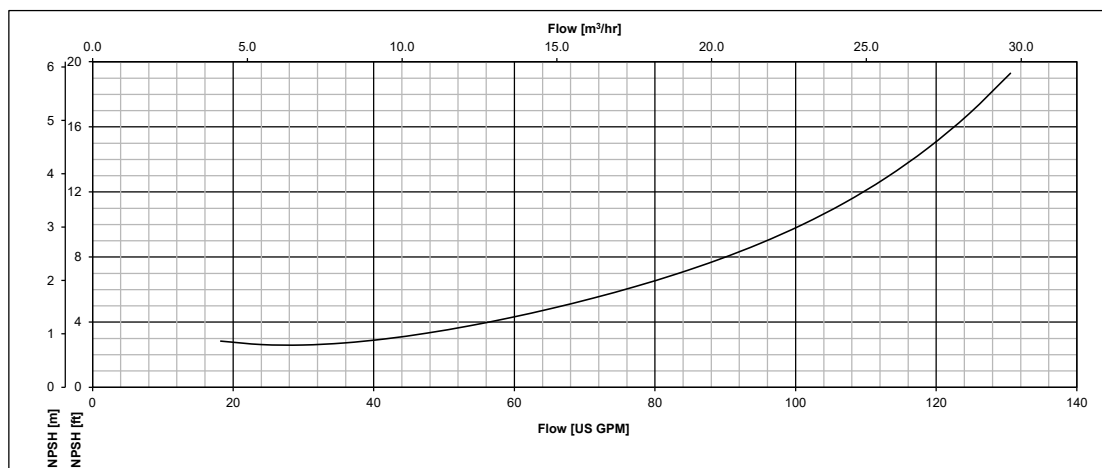
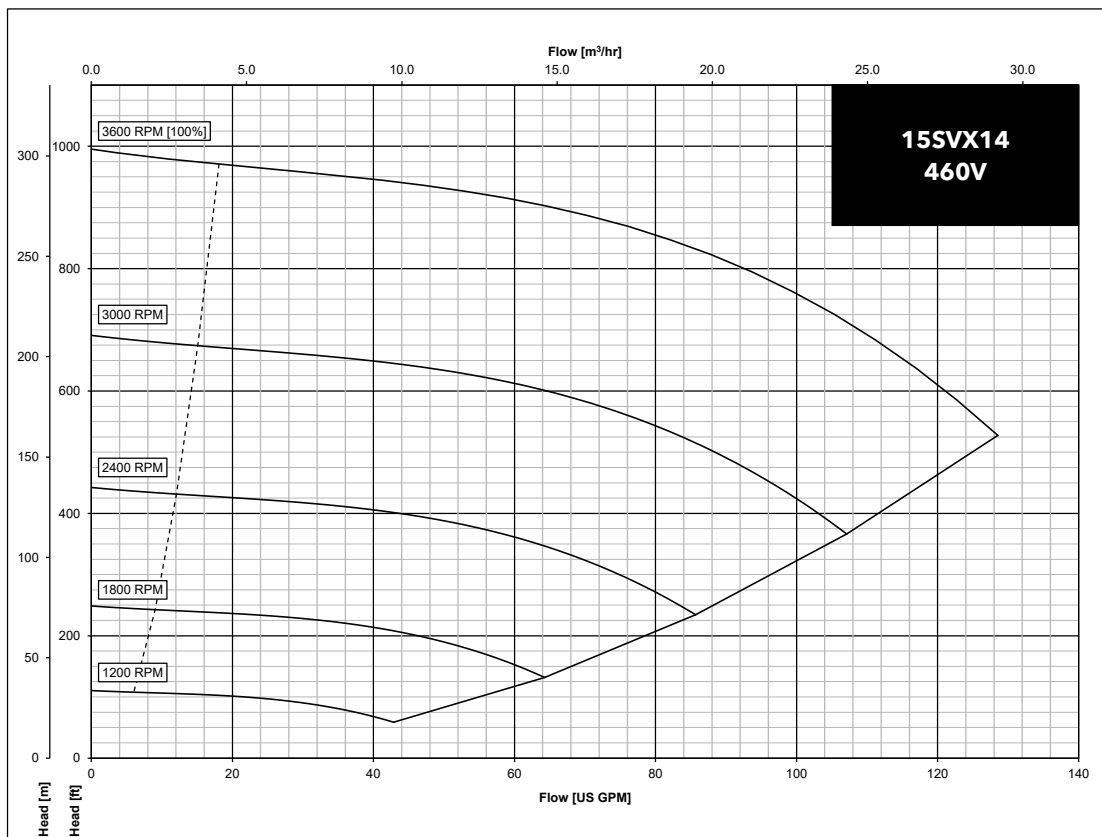

The performances are valid for liquid with density $\rho = 1.0 \text{ Kg/dm}^3$ and kinematic viscosity $\nu = 1 \text{ mm}^2/\text{sec}$.

22 SVX SERIES DIMENSIONS AND WEIGHTS

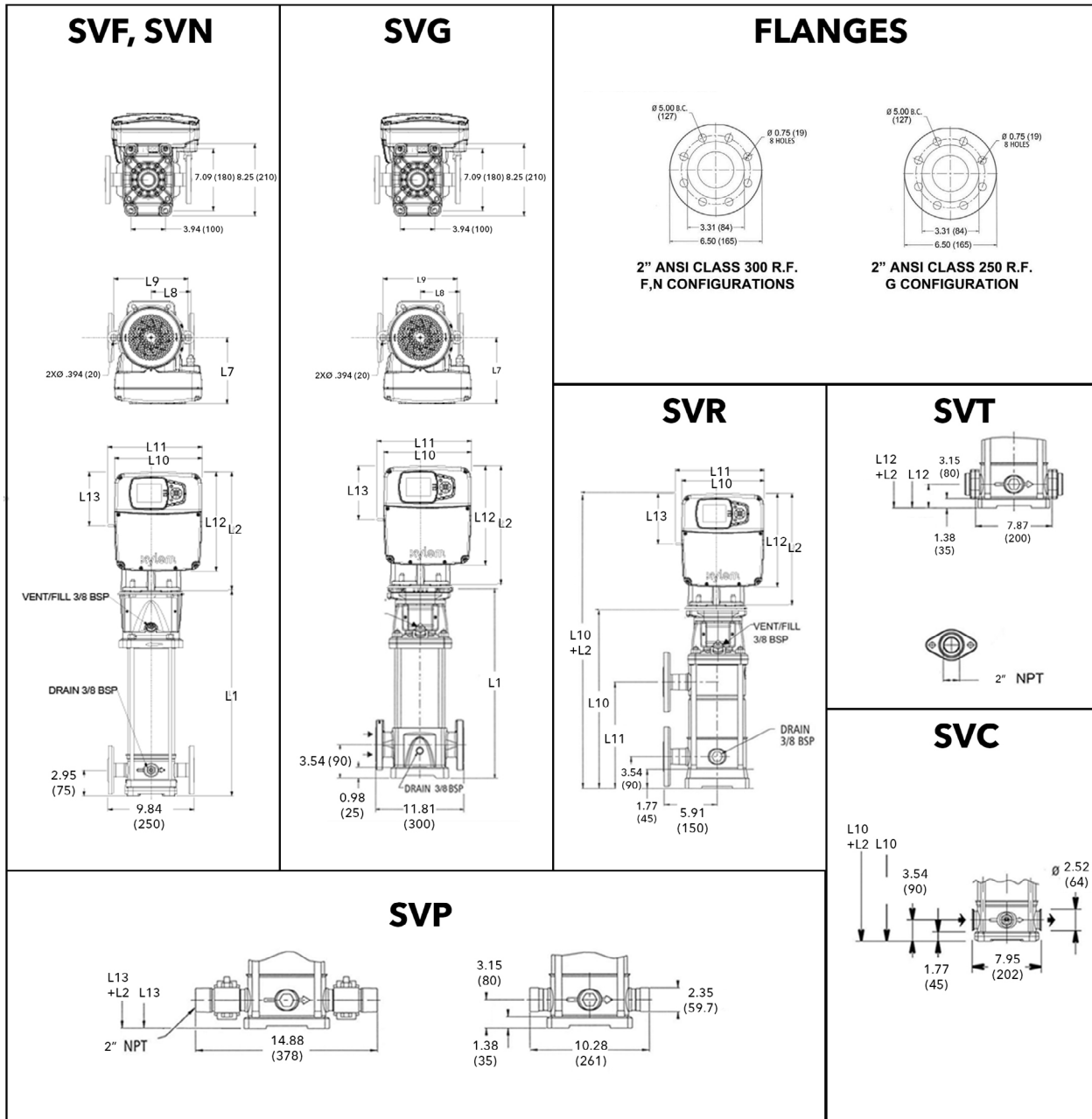

22SVX SERIES - 60 HZ, 3600 RPM TEFC ENCLOSURES

Pump Type Stages	Motor				Dimensions (in)													Weight (lbs.)		
	Voltage	HP	NEMA Frame	Motor Type	L1	L2	L3	L4	L5	L6	L7	L8	L9	L10	L11	L12	L13	Pump Only	Motor	Pump/Motor
			"TEFC 3Ø"																	
22SVX-02	380-480	5.5	143TC	EXM143-145TC/4.055BH2	18.71	13.53	10.08	10.83	11.36	6.15	7.62	4.53	8.50	-	-	18.32	18.32	45	47	92
	200-240	7.5	213TC	EXM213-215TC/3.075CH2	18.71	16.14	11.885	12.983	13.095	8.207	9.484	5.321	10.433	-	-	18.32	18.32	45	112	157
22SVX-03	380-480	7.5	143TC	EXM143-145TC/4.075BH2	20.60	13.53	10.08	10.83	11.36	6.15	7.62	4.53	8.50	-	-	20.21	20.21	48	55	103
	200-240	7.5	213TC	EXM213-215TC/3.075CH2	20.60	16.14	11.885	12.983	13.095	8.207	9.484	5.321	10.433	-	-	20.21	20.21	48	112	160
22SVX-04	380-480	10	213TC	EXM213-215TC/4.100CH2	23.06	16.14	11.89	12.98	13.10	8.21	9.48	5.32	10.43	23.06	11.85	22.67	22.67	58	97	155
	200-240	15	254TC	EXM254-256TC/3.150DH2	23.06	19.291	14.248	15.16	15.723	9.567	12.169	6.585	12.5	23.06	11.85	22.67	22.67	58	148	206
22SVX-07	380-480	15	213TC	EXM213-215TC/4.150CH2	29.38	16.14	11.89	12.98	13.10	8.21	9.48	5.32	10.43	29.38	17.52	28.99	28.99	72	112	184
	200-240	15	254TC	EXM254-256TC/3.150DH2	29.38	19.291	14.248	15.16	15.723	9.567	12.169	6.585	12.5	29.38	17.52	28.99	28.99	72	148	220
22SVX-09	380-480	25	254TC	EXM254-256TC/4.250DH2	33.16	19.29	14.25	15.16	15.72	9.57	12.17	6.59	12.50	33.16	21.30	-	32.77	77	174	251
22SVX-12	380-480	30	254TC	EXM254-256TC/4.300DH2	39.46	19.29	14.25	15.16	15.72	9.57	12.17	6.59	12.50	-	-	-	39.07	95	187	282

22SVX02 SERIES OPERATING CHARACTERISTICS

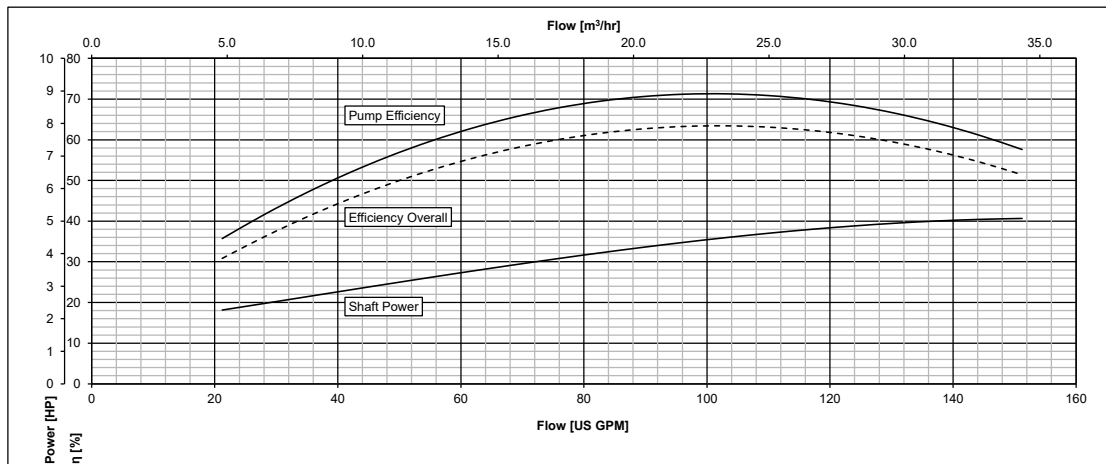
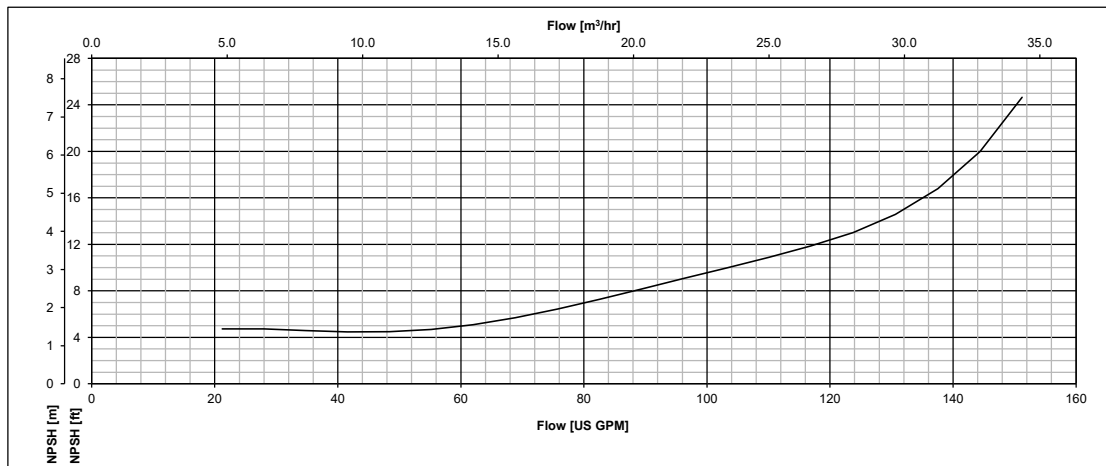
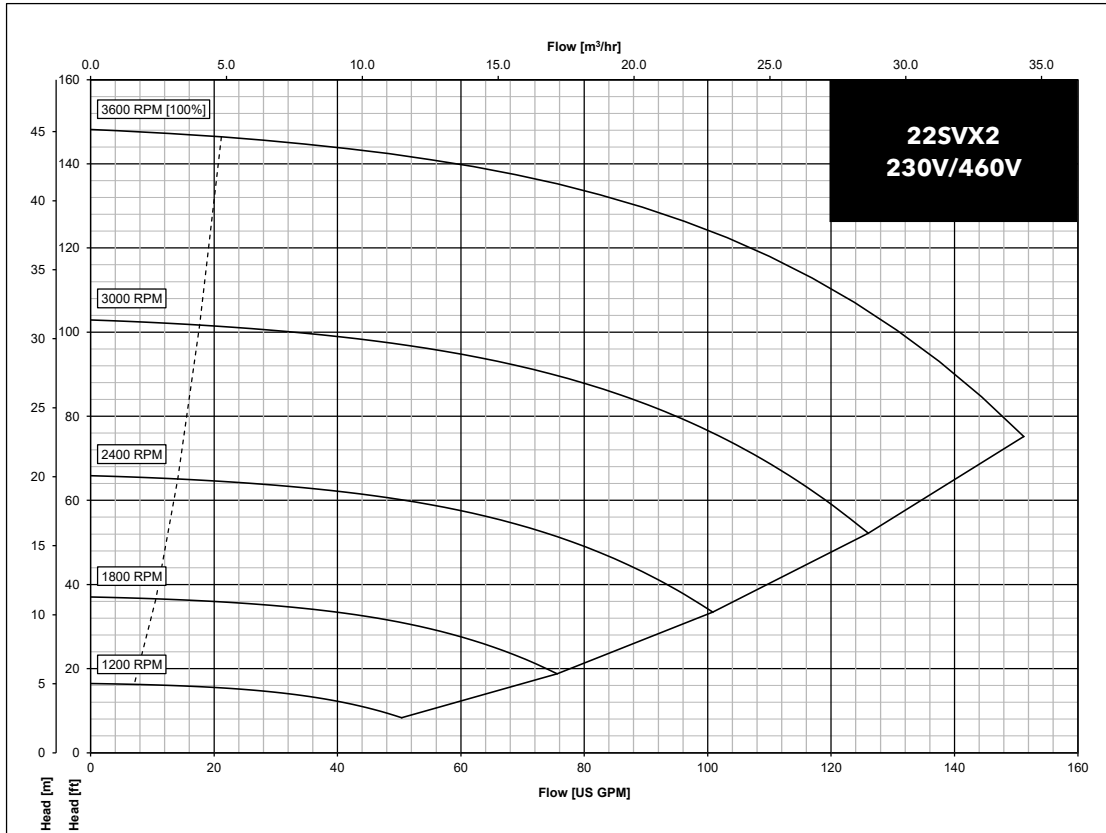

22SVX03 SERIES OPERATING CHARACTERISTICS

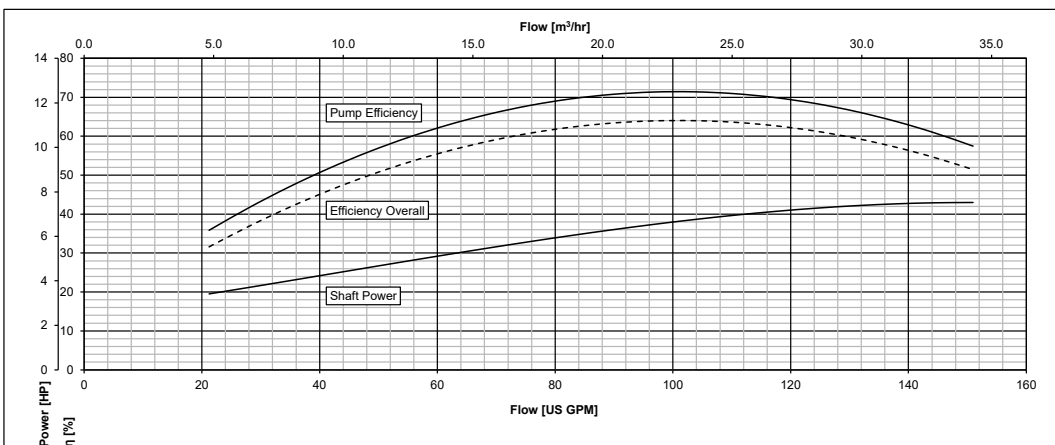
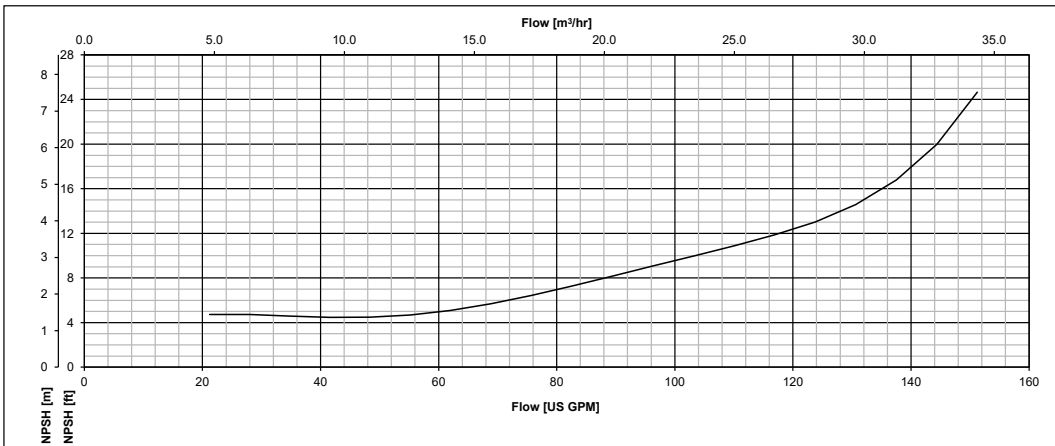
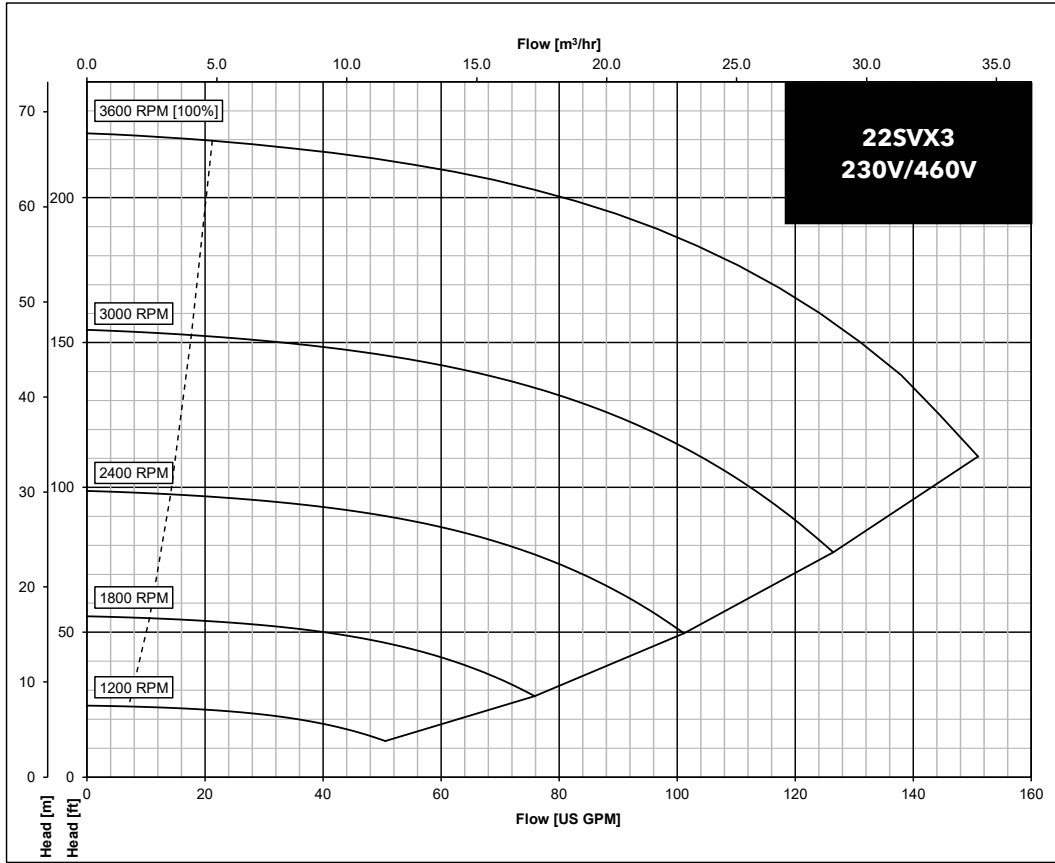

22SVX04 SERIES OPERATING CHARACTERISTICS

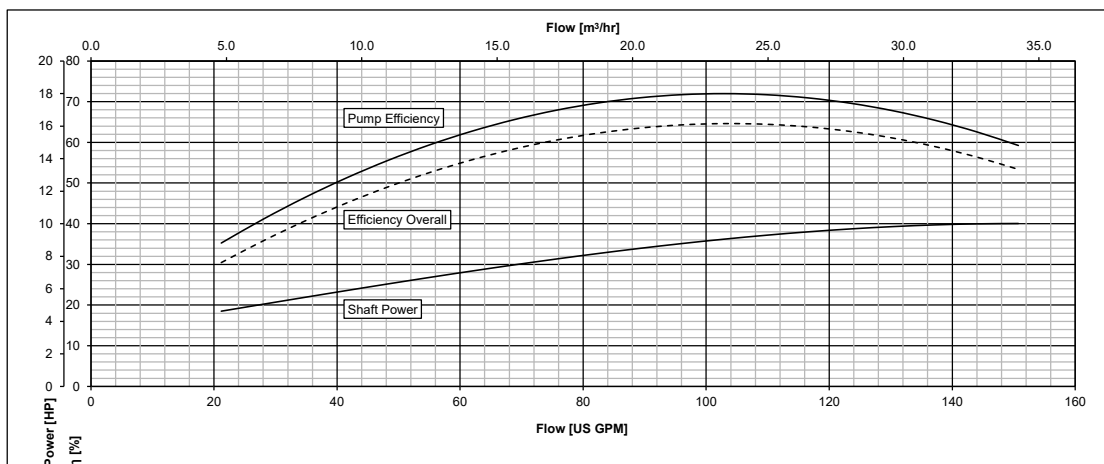
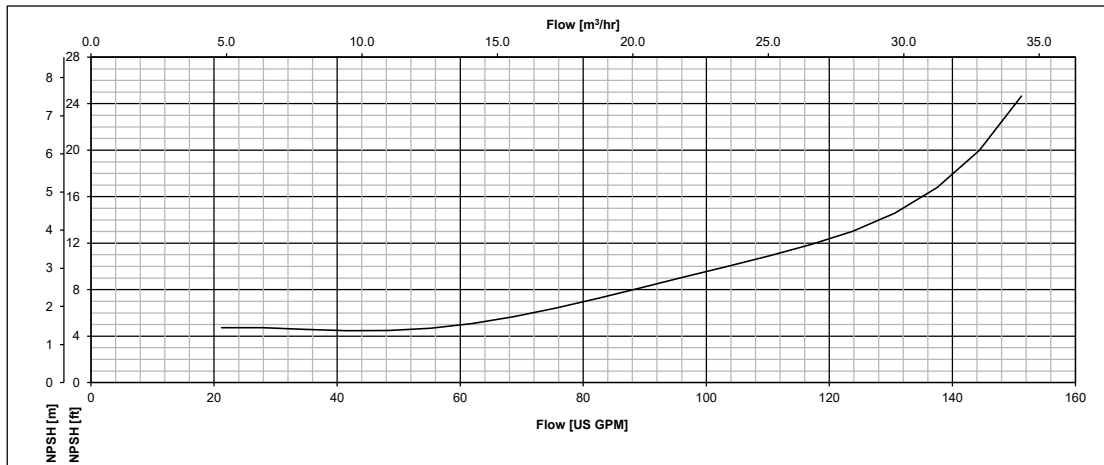
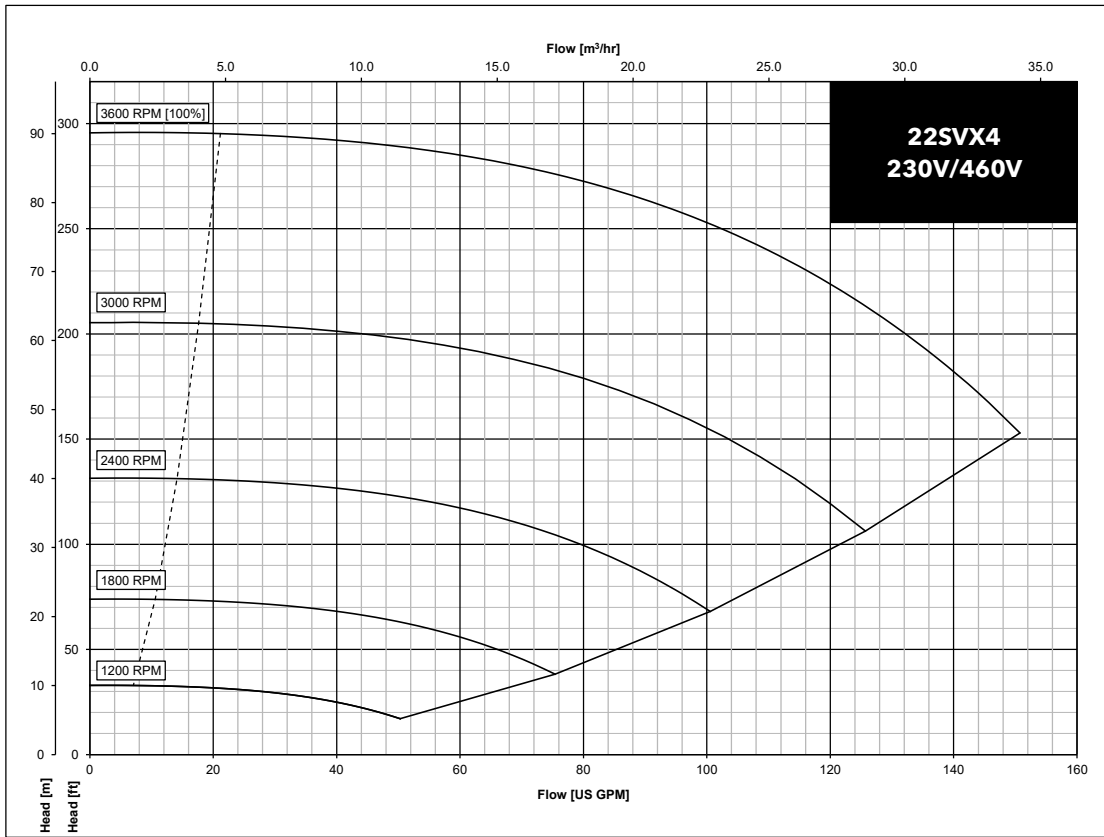

22SVX07 SERIES OPERATING CHARACTERISTICS

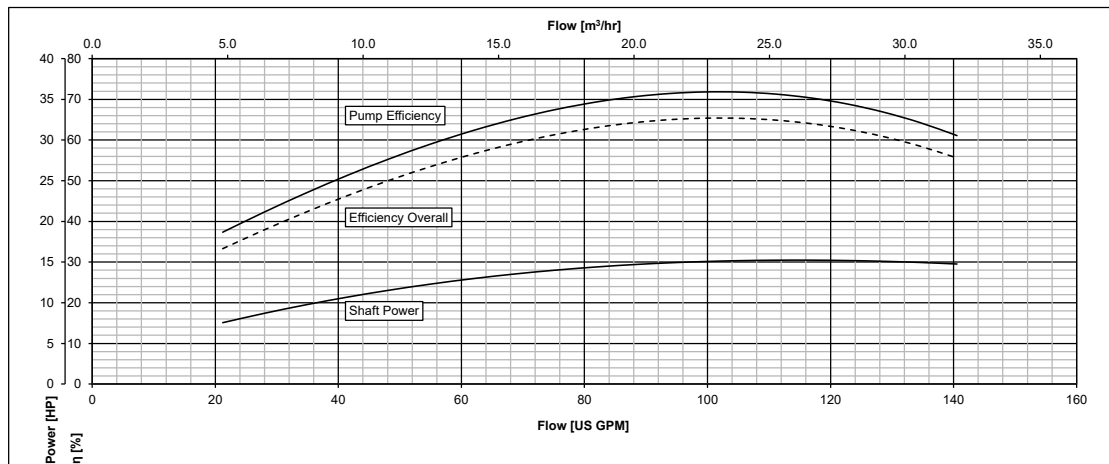
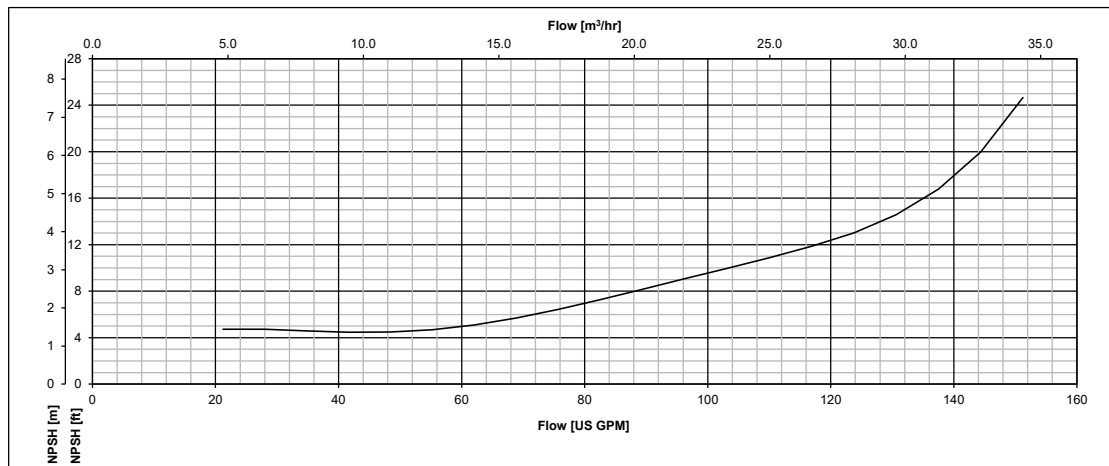
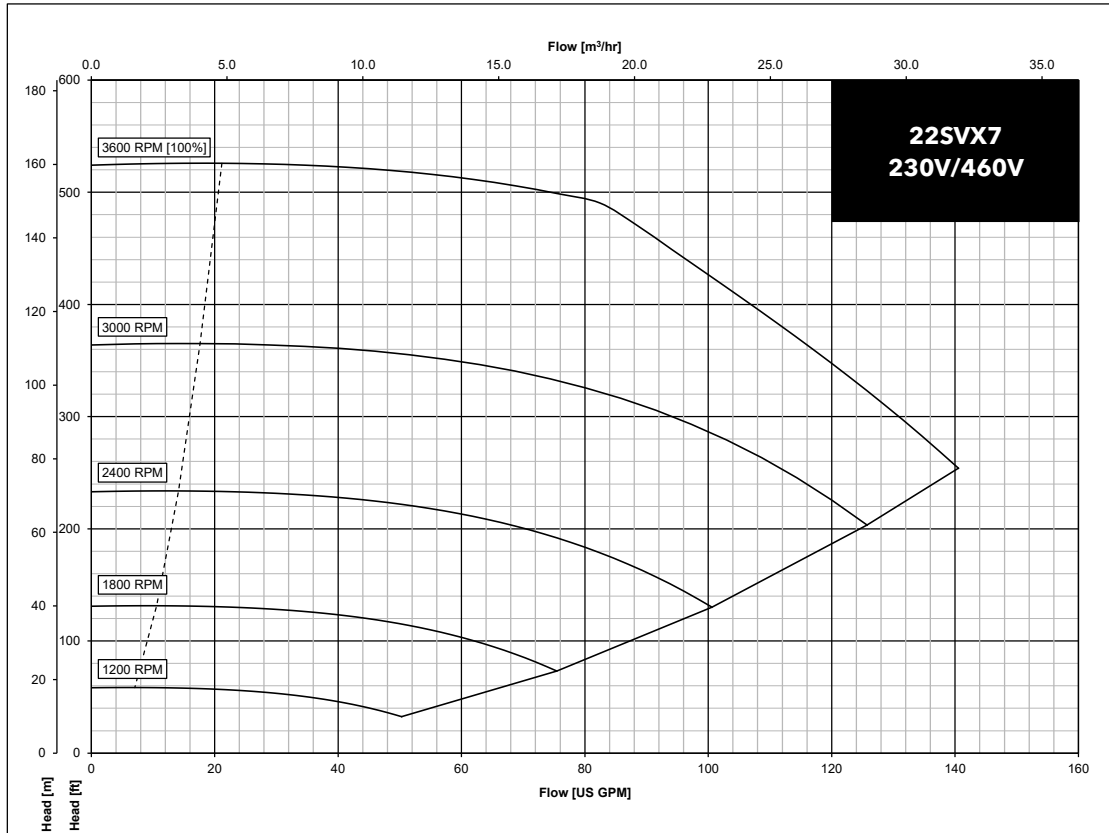

The performances are valid for liquid with density $\rho = 1.0 \text{ Kg/dm}^3$ and kinematic viscosity $\nu = 1 \text{ mm}^2/\text{sec}$.

22SVX09 SERIES OPERATING CHARACTERISTICS

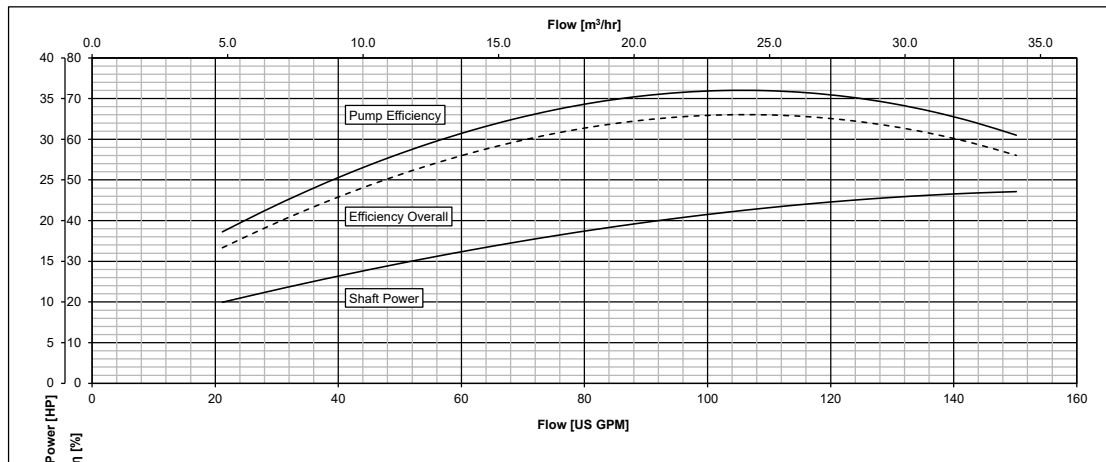
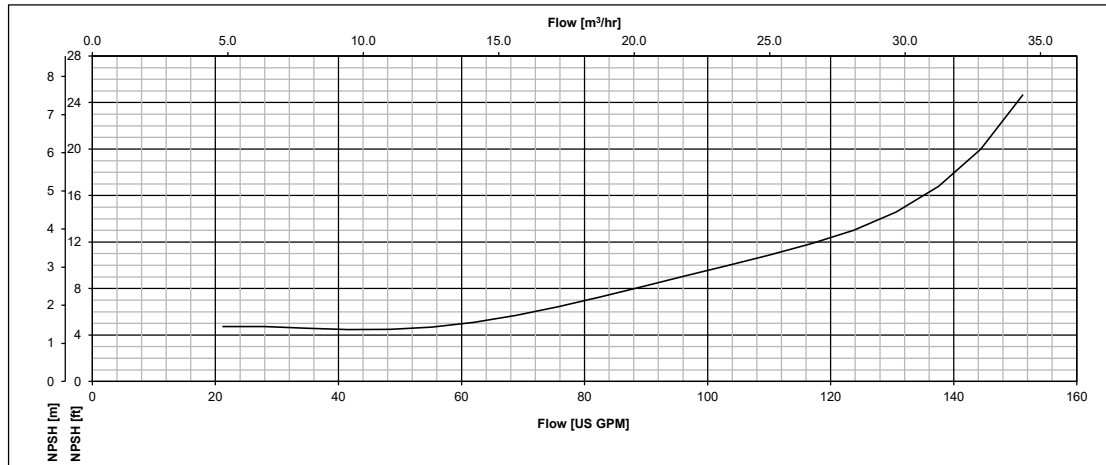
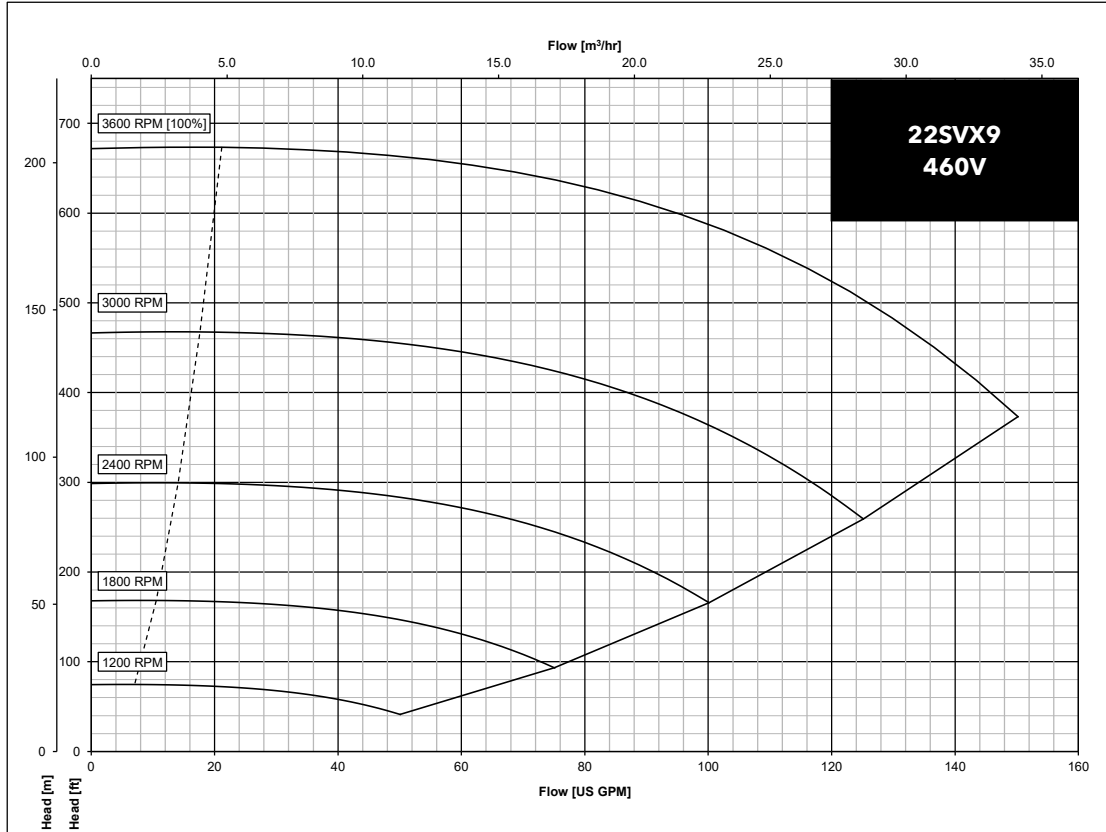

22SVX12 SERIES OPERATING CHARACTERISTICS

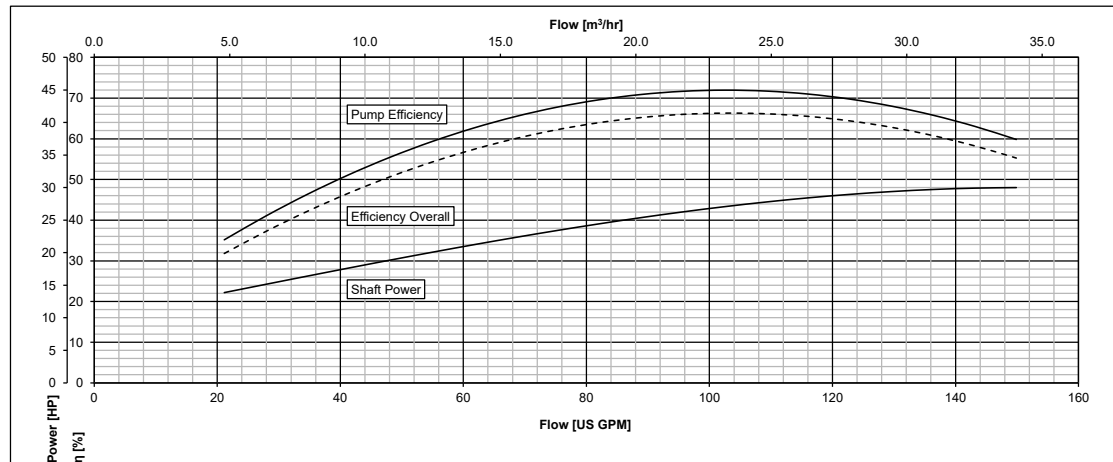
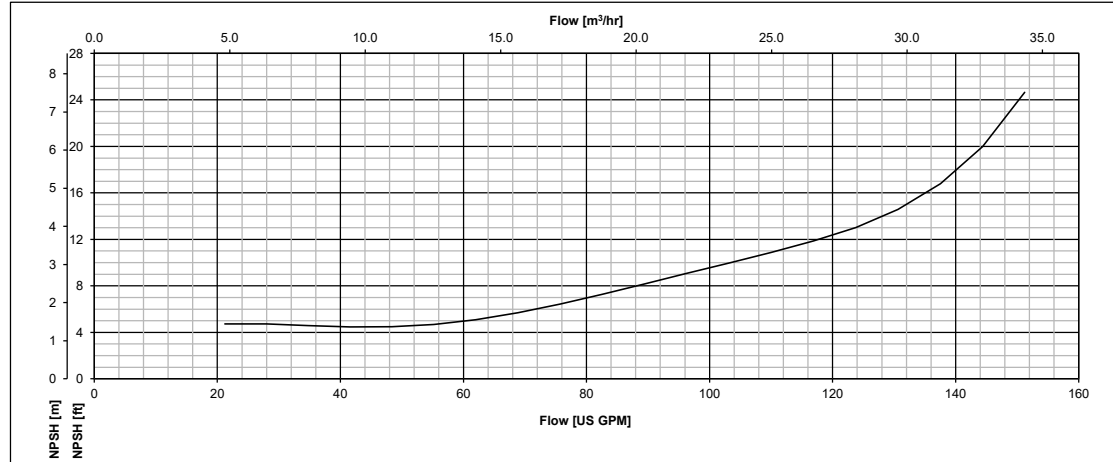
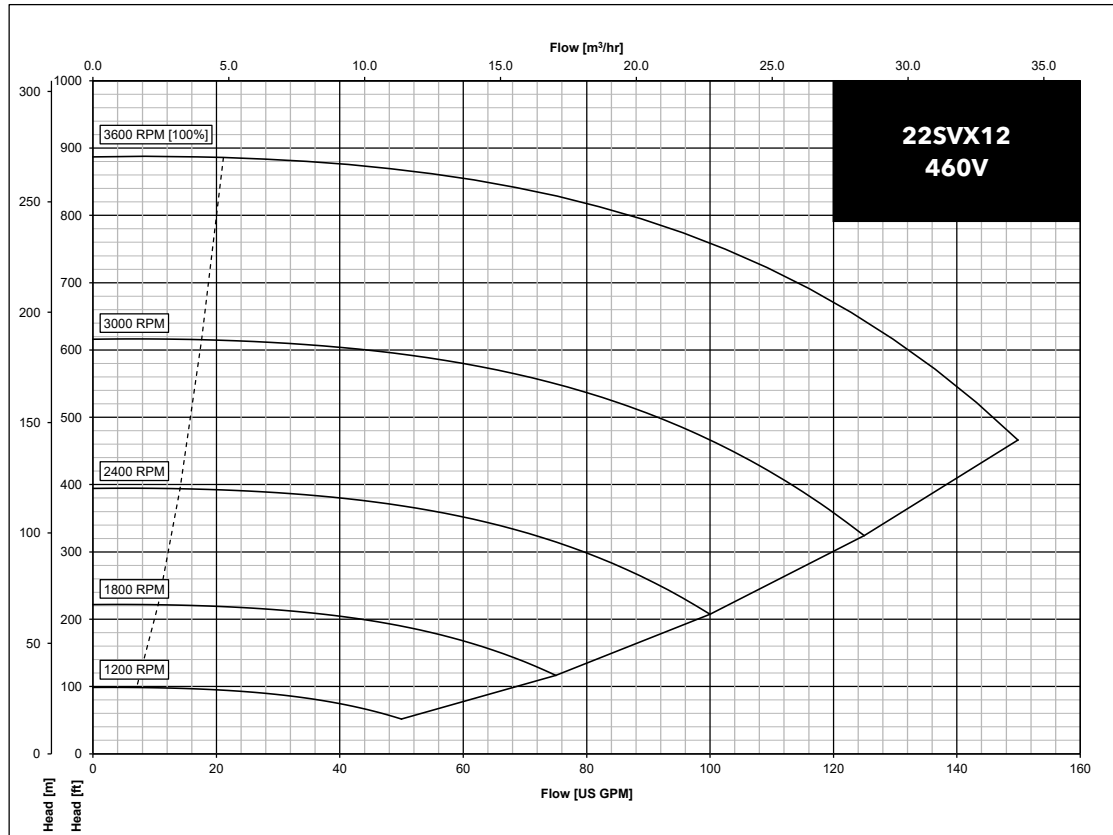

The performances are valid for liquid with density $\rho = 1.0 \text{ Kg/dm}^3$ and kinematic viscosity $\nu = 1 \text{ mm}^2/\text{sec}$.

33 SVX SERIES DIMENSIONS AND WEIGHTS

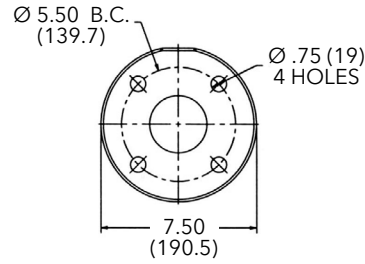
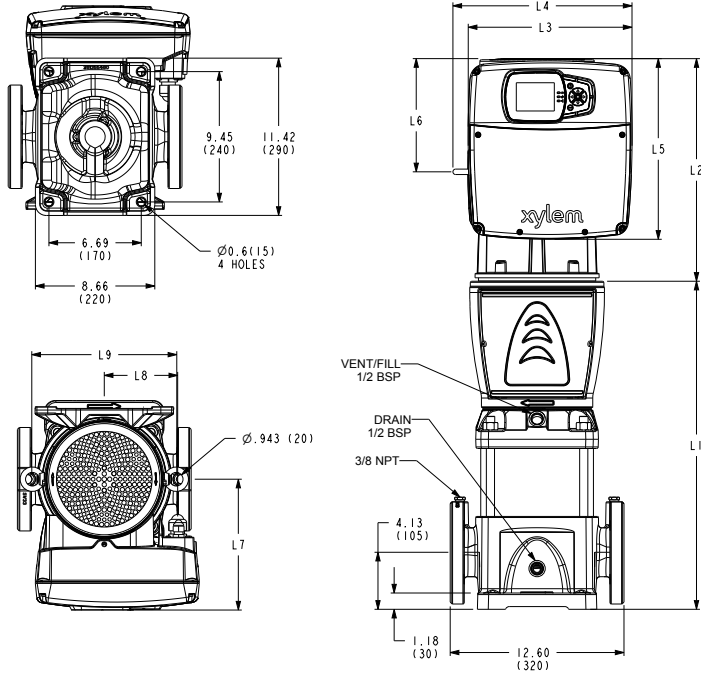

Cast Iron
2 1/2" Class 125 F.F.

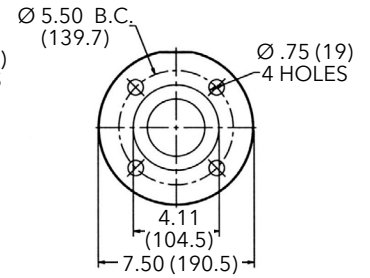

316SS
2 1/2" Class 150 R.F.

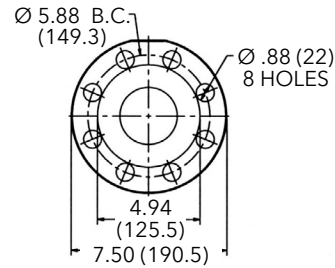

Cast Iron
2 1/2" Class 250 R.F.

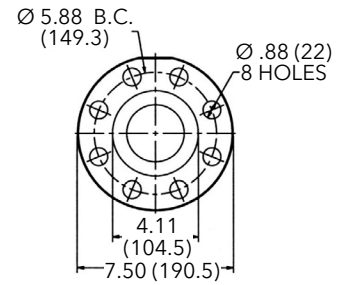

316SS
2 1/2" Class 300 R.F.

Commercial Water

33SVX SERIES - 60 HZ, 3600 RPM TEFC ENCLOSURES

Pump Type Stages	Motor				Dimensions (in)													Weight (lbs.)		
	Voltage	HP	NEMA Frame "TEFC 3Ø"	Motor Type	L1	L2	L3	L4	L5	L6	L7	L8	L9	Pump Only	Motor	Pump/Motor	L13	"Pump Only"	Motor	Pump/Motor
33SVX-01	380-480	7.5	213TC	EXM213-215TC/4.075CH2	20.62	16.14	11.89	12.98	13.10	8.21	9.48	5.32	10.43	132	112	244	18.32	45	47	92
	200-240	7.5	213TC	EXM213-215TC/3.075CH2	20.62	16.14	11.89	12.98	13.10	8.21	9.48	5.32	10.43	132	112	244	18.32	45	112	157
33SVX-2/1	380-480	10	213TC	EXM213-215TC/4.100CH2	23.58	16.14	11.89	12.98	13.10	8.21	9.48	5.32	10.43	143	97	240	20.21	48	55	103
	200-240	15	254TC	EXM254-256TC/3.150DH2	23.58	19.291	14.248	15.16	15.723	9.567	12.169	6.585	12.5	143	148	291	20.21	48	112	160
33SVX-02	380-480	15	213TC	EXM213-215TC/4.150CH2	23.58	16.14	11.89	12.98	13.10	8.21	9.48	5.32	10.43	143	112	255	22.67	58	97	155
	200-240	15	254TC	EXM254-256TC/3.150DH2	23.58	19.291	14.248	15.16	15.723	9.567	12.169	6.585	12.5	143	148	291	22.67	58	148	206
33SVX-4/2	380-480	20	254TC	EXM254-256TC/4.200DH2	29.50	19.29	14.25	15.16	15.72	9.57	12.17	6.59	12.50	161	161	322	28.99	72	112	184
	200-240	20	254TC	EXM254-256TC/3.200DH2	29.50	19.29	14.25	15.16	15.72	9.57	12.17	6.59	12.50	161	161	322	28.99	72	148	220
33SVX-04	380-480	25	254TC	EXM254-256TC/4.250DH2	29.50	19.29	14.25	15.16	15.72	9.57	12.17	6.59	12.50	161	174	335	32.77	77	174	251
33SVX-05	380-480	30	254TC	EXM254-256TC/4.300DH2	32.44	19.29	14.25	15.16	15.72	9.57	12.17	6.59	12.50	186	187	373	39.07	95	187	282

33SVX01 SERIES OPERATING CHARACTERISTICS

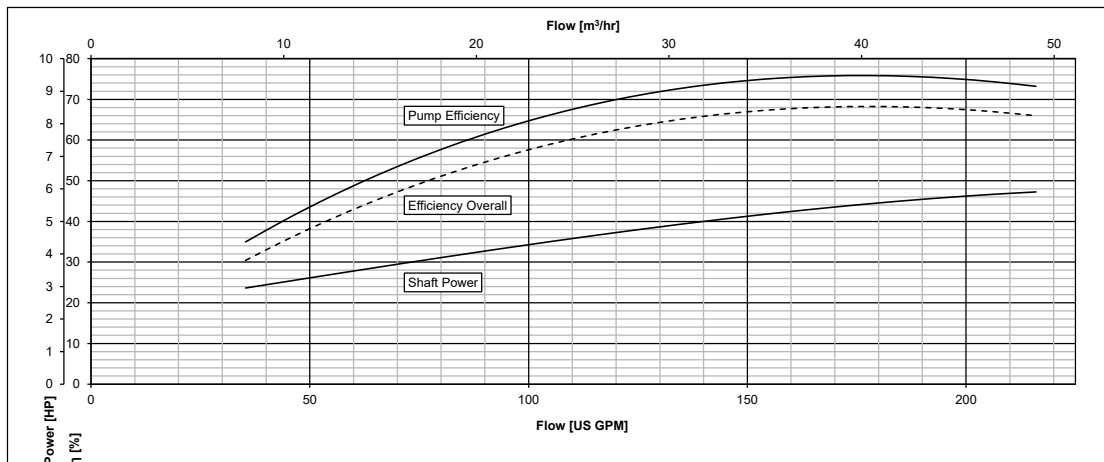
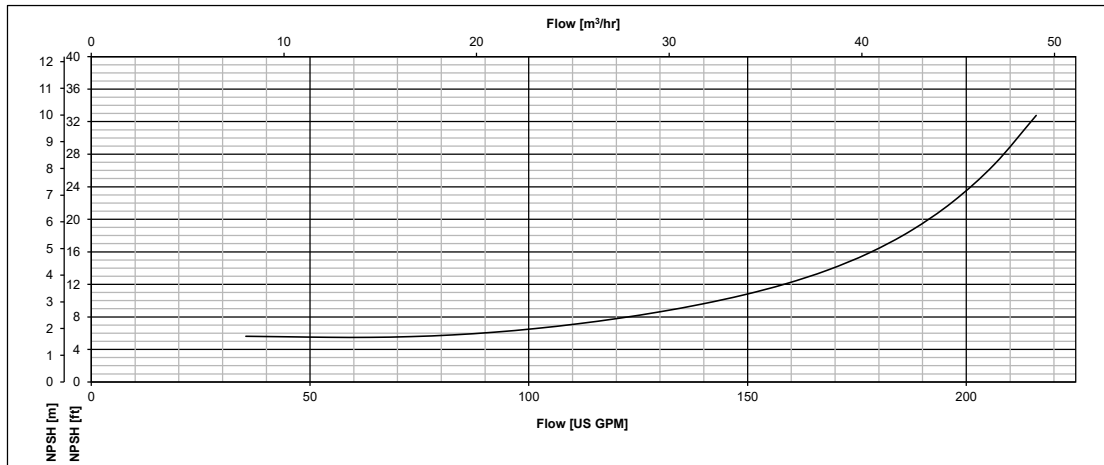
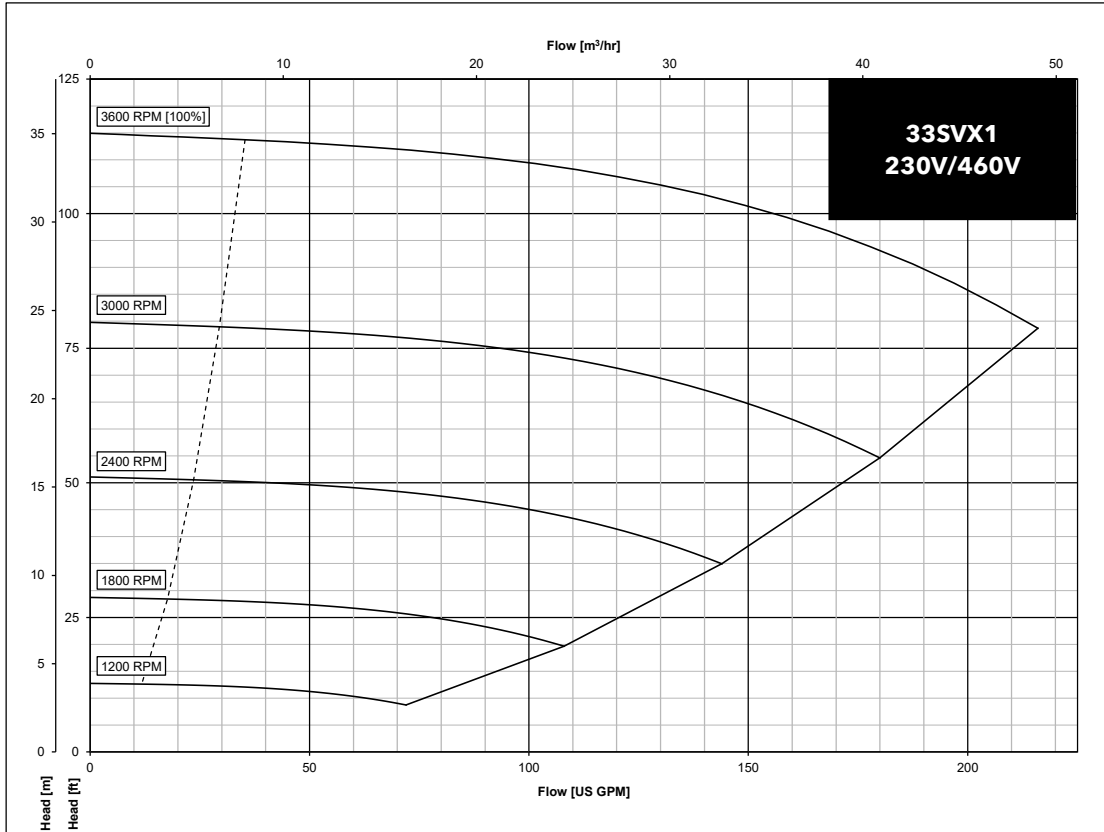

33SVX2/1 SERIES OPERATING CHARACTERISTICS

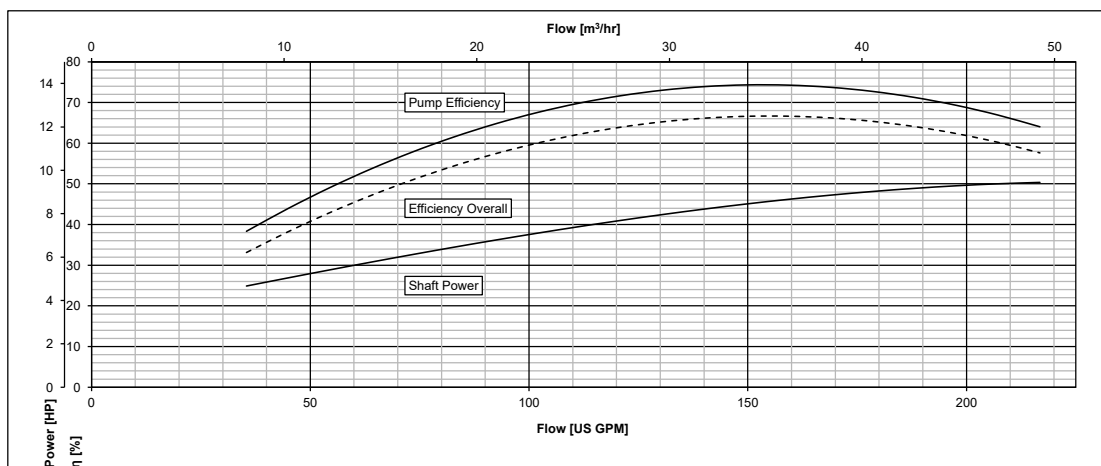
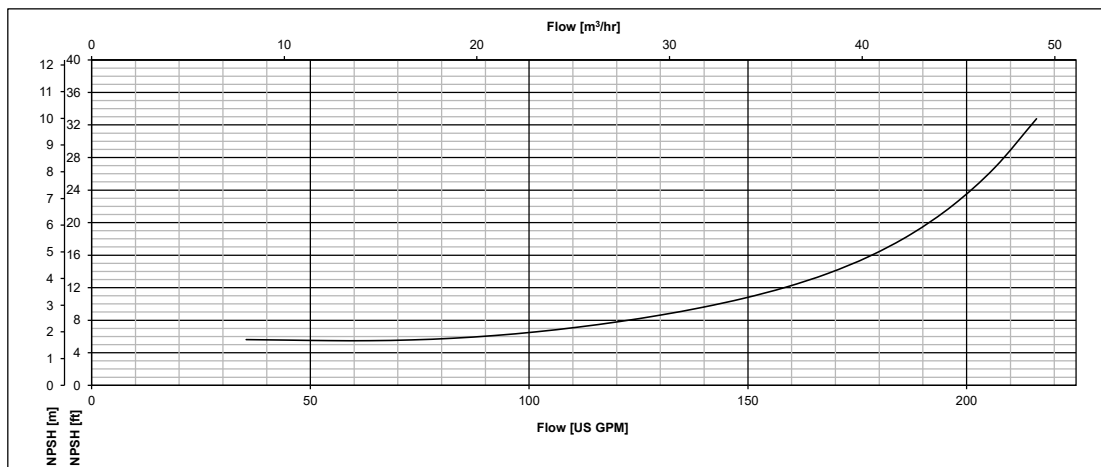
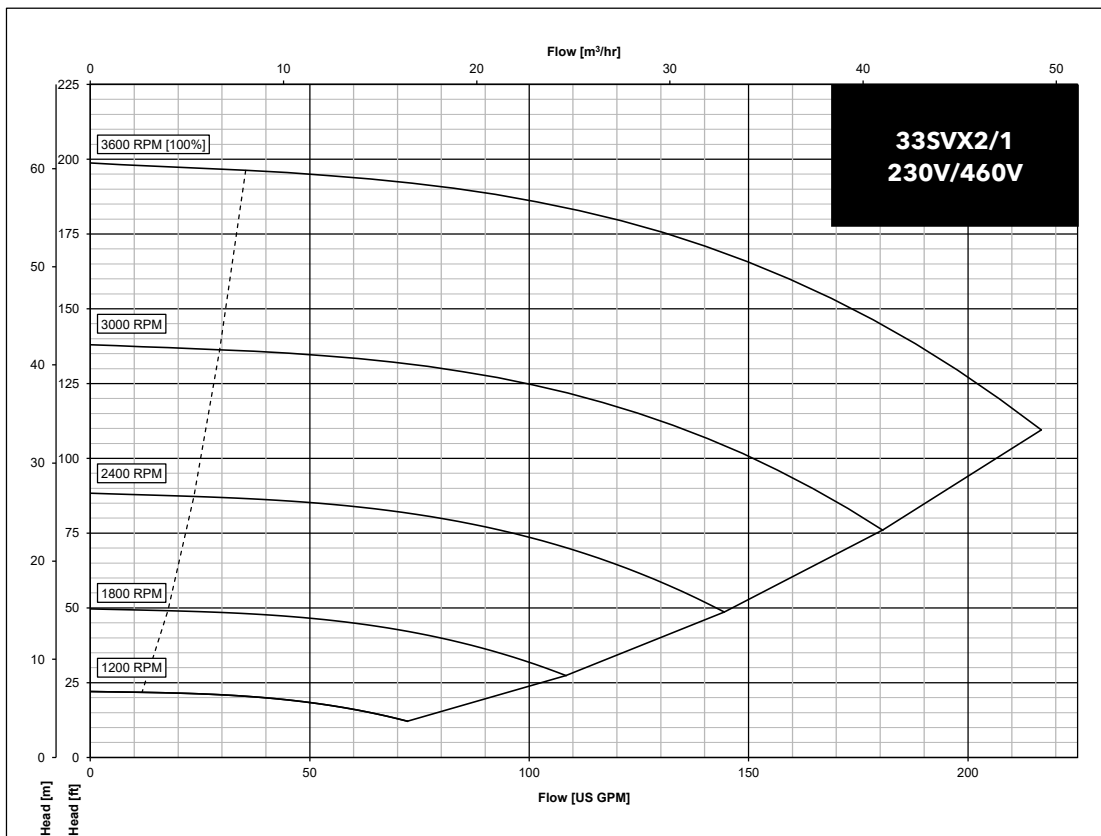

The performances are valid for liquid with density $\rho = 1.0 \text{ Kg/dm}^3$ and kinematic viscosity $\nu = 1 \text{ mm}^2/\text{sec}$.

33SVX02 SERIES OPERATING CHARACTERISTICS

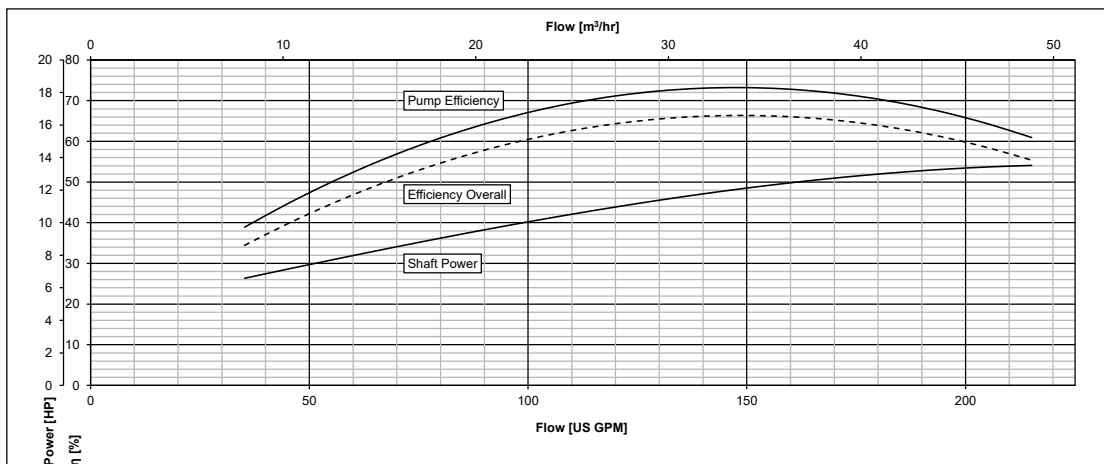
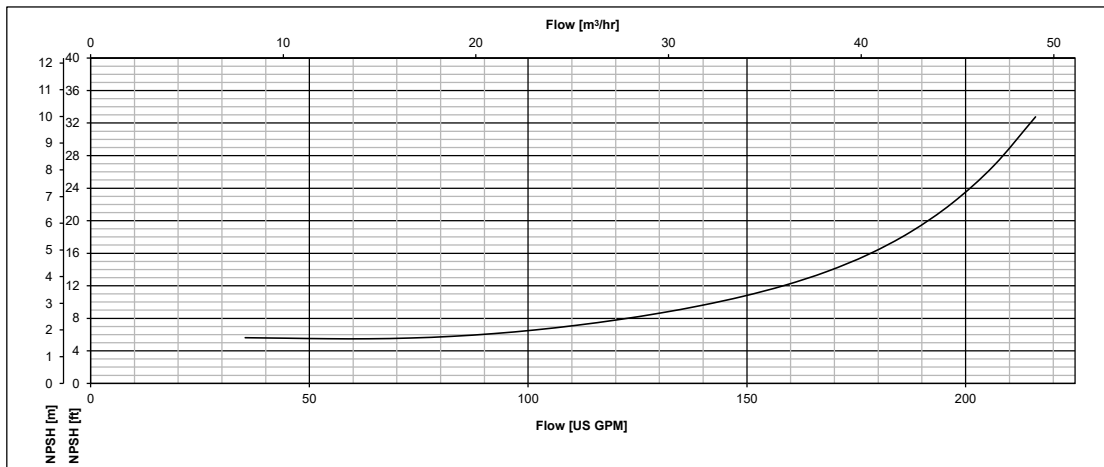
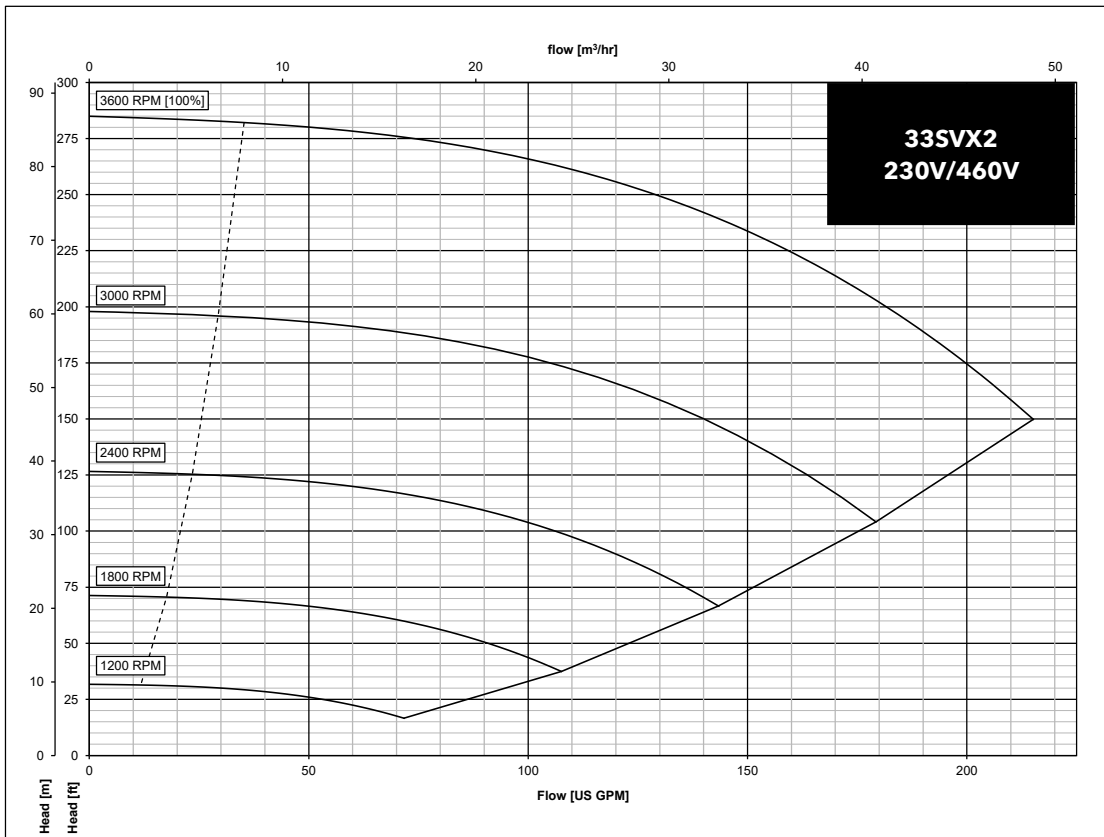

33SVX4/2 SERIES OPERATING CHARACTERISTICS

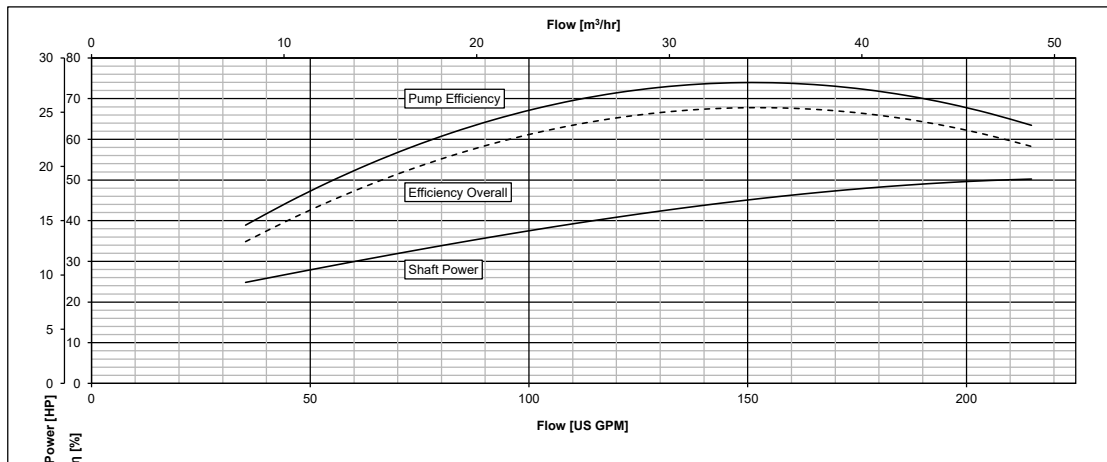
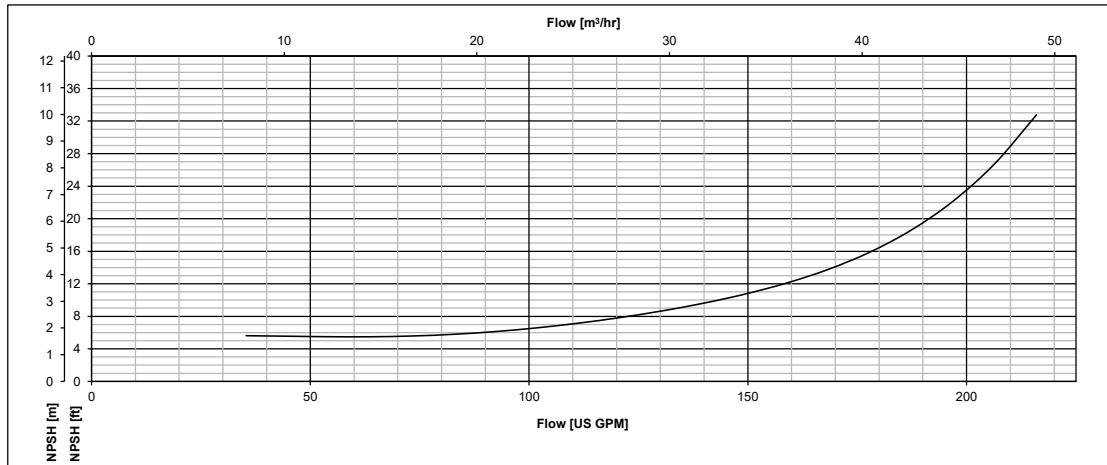
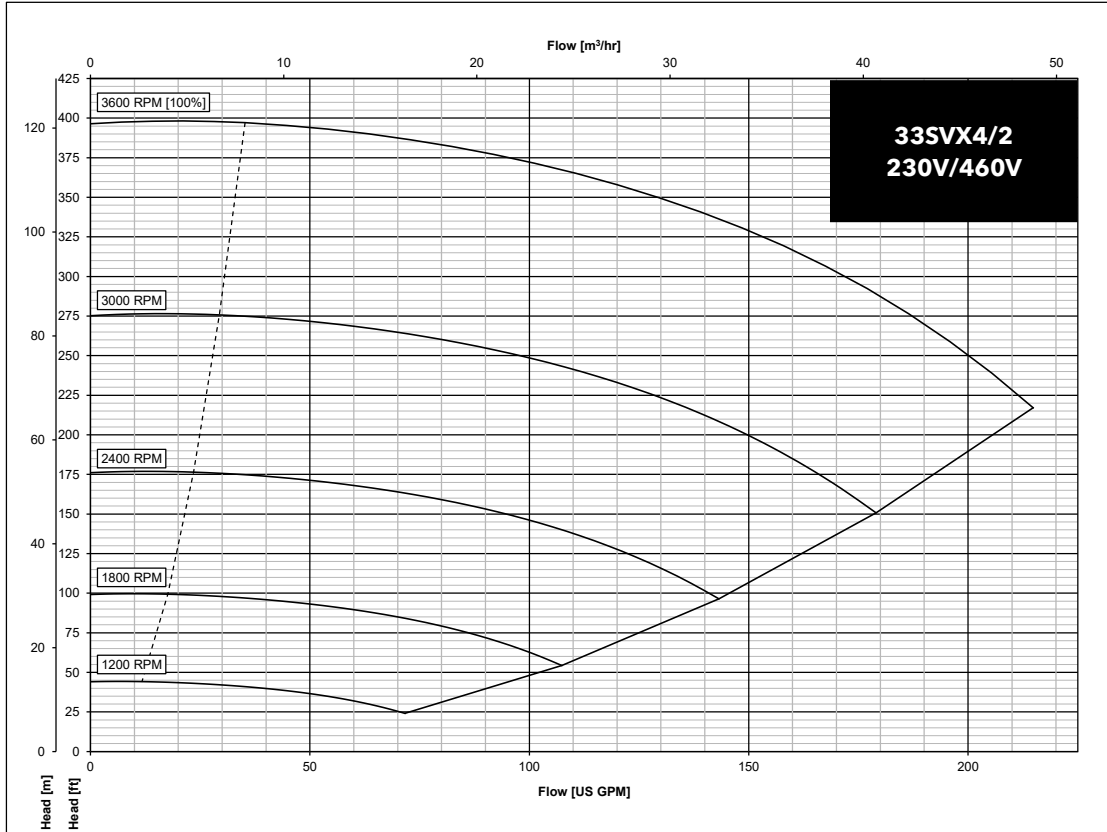

The performances are valid for liquid with density $\rho = 1.0 \text{ Kg/dm}^3$ and kinematic viscosity $\nu = 1 \text{ mm}^2/\text{sec}$.

33SVX04 SERIES OPERATING CHARACTERISTICS

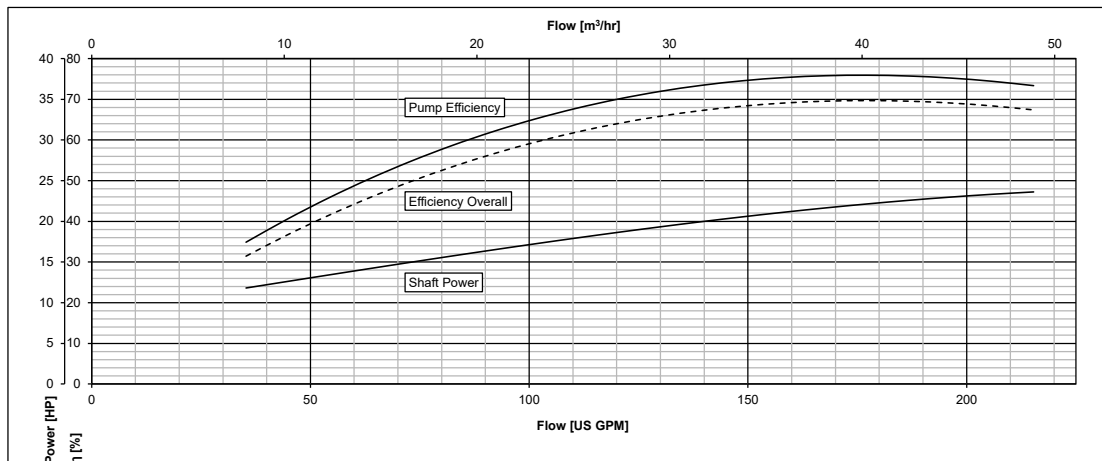
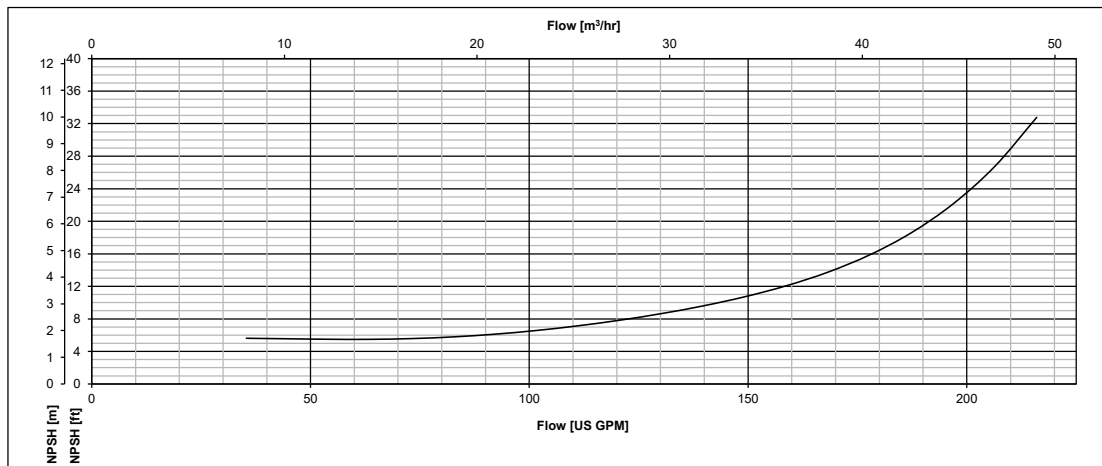
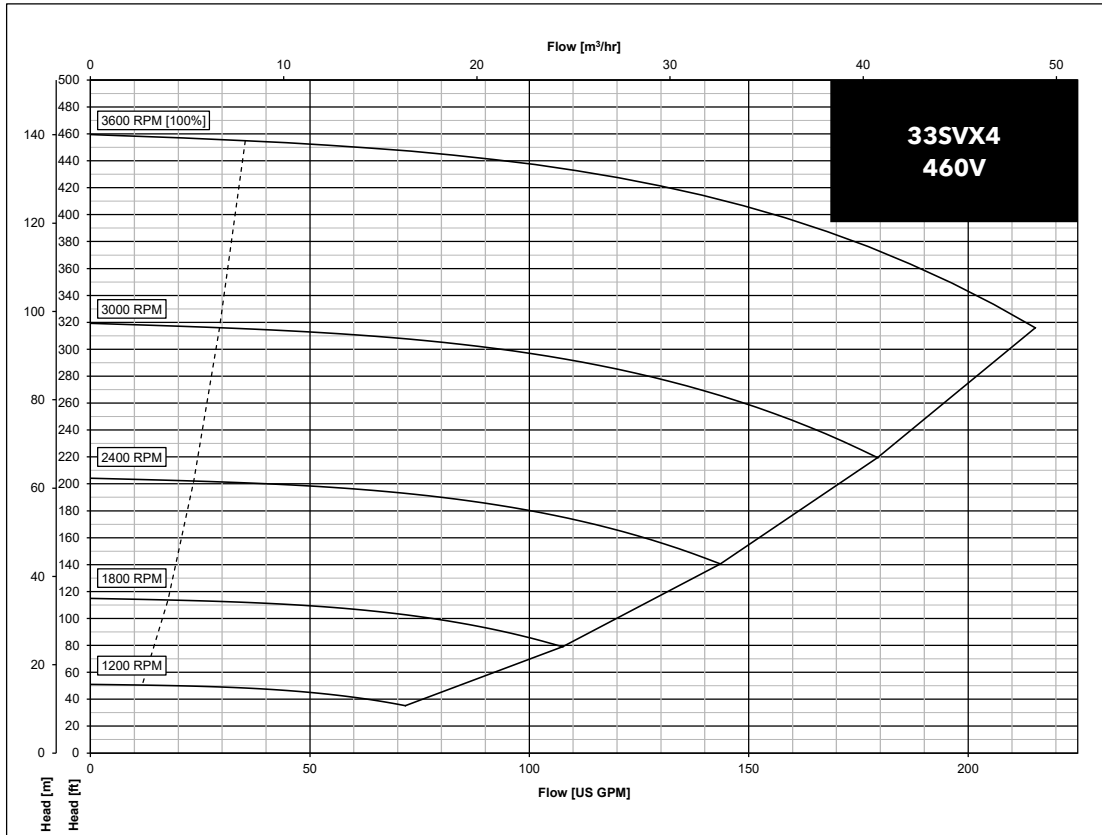

33SVX05 SERIES OPERATING CHARACTERISTICS

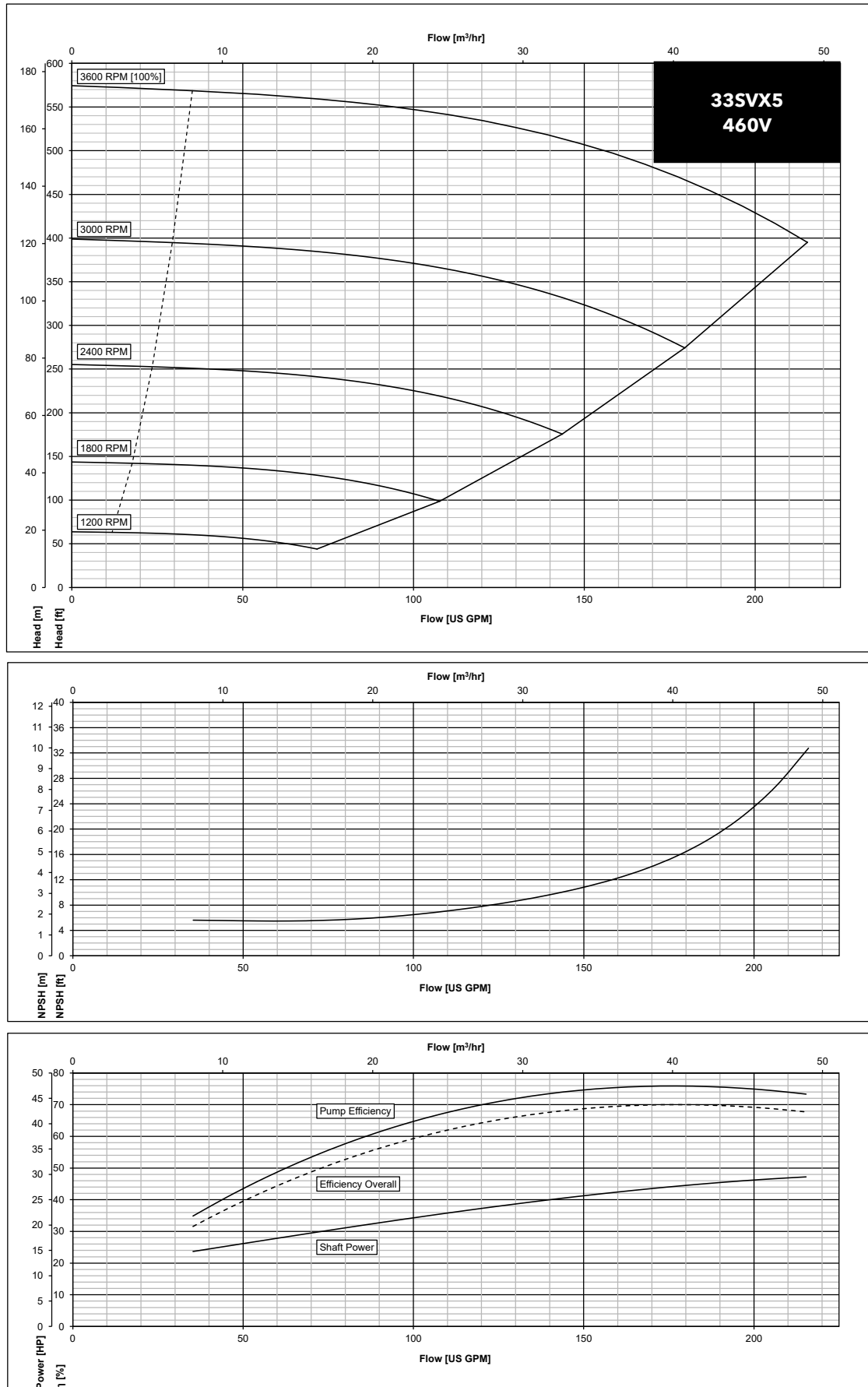

The performances are valid for liquid with density $\rho = 1.0 \text{ Kg/dm}^3$ and kinematic viscosity $\nu = 1 \text{ mm}^2/\text{sec}$.

46 SVX SERIES DIMENSIONS AND WEIGHTS

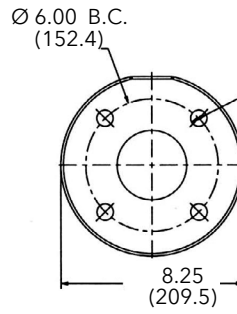
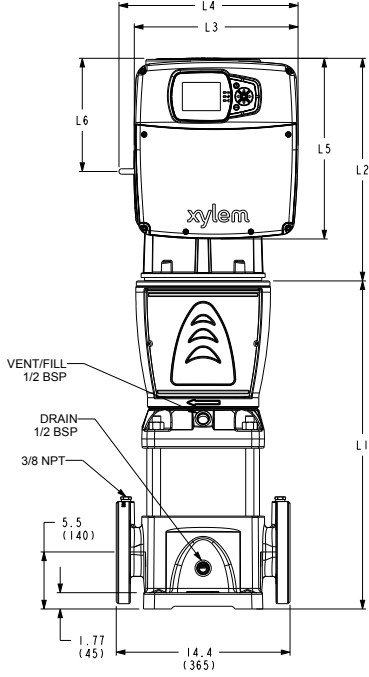
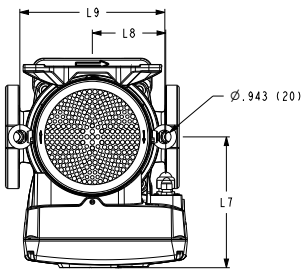
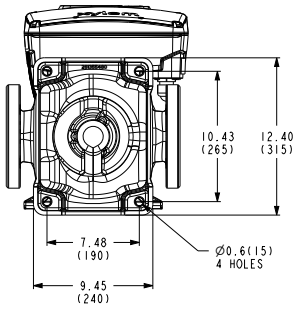

Cast Iron
3" Class 125 F.F.

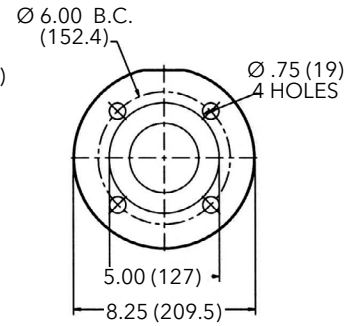

316SS
3" Class 150 R.F.

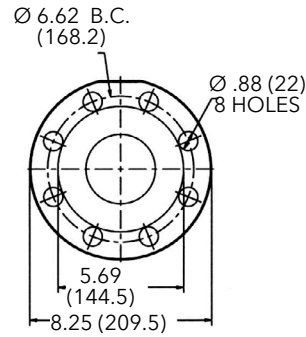

Cast Iron
3" Class 250 R.F.

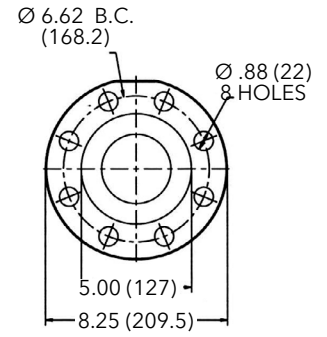

316SS
3" Class 300 R.F.

46SVX SERIES - 60 HZ, 3600 RPM TEFC ENCLOSURES

Pump Type Stages	Motor				Dimensions (in)									Weight (lbs.)		
	Voltage	HP	NEMA Frame	Motor Type	L1	L2	L3	L4	L5	L6	L7	L8	L9	Pump Only	Motor	Pump/Motor
			"TEFC 3Ø"													
46SVX-01	380-480	7.5	213TC	EXM213-215TC/4.075CH2	22.19	16.14	11.89	12.98	13.10	8.21	9.48	5.32	10.43	174	112	286
	200-240	7.5	213TC	EXM213-215TC/3.075CH2	22.19	16.14	11.89	12.98	13.10	8.21	9.48	5.32	10.43	174	112	286
46SVX-2/1	380-480	15	213TC	EXM213-215TC/4.150CH2	25.19	16.14	11.89	12.98	13.10	8.21	9.48	5.32	10.43	158	112	270
	200-240	15	254TC	EXM254-256TC/3.150DH2	25.19	19.29	14.25	15.16	15.72	9.57	12.17	6.59	12.50	158	148	306
46SVX-3/2	380-480	20	254TC	EXM254-256TC/4.200DH2	28.12	19.29	14.25	15.16	15.72	9.57	12.17	6.59	12.50	169	161	330
	200-240	20	254TC	EXM254-256TC/3.200DH2	28.12	19.29	14.25	15.16	15.72	9.57	12.17	6.59	12.50	169	161	330
46SVX-03	380-480	25	254TC	EXM254-256TC/4.250DH2	29.63	19.29	14.25	15.16	15.72	9.57	12.17	6.59	12.50	183	174	357
46SVX-4/1	380-480	30	254TC	EXM254-256TC/4.300DH2	32.63	19.29	14.25	15.16	15.72	9.57	12.17	6.59	12.50	192	187	379

46SVX01 SERIES OPERATING CHARACTERISTICS

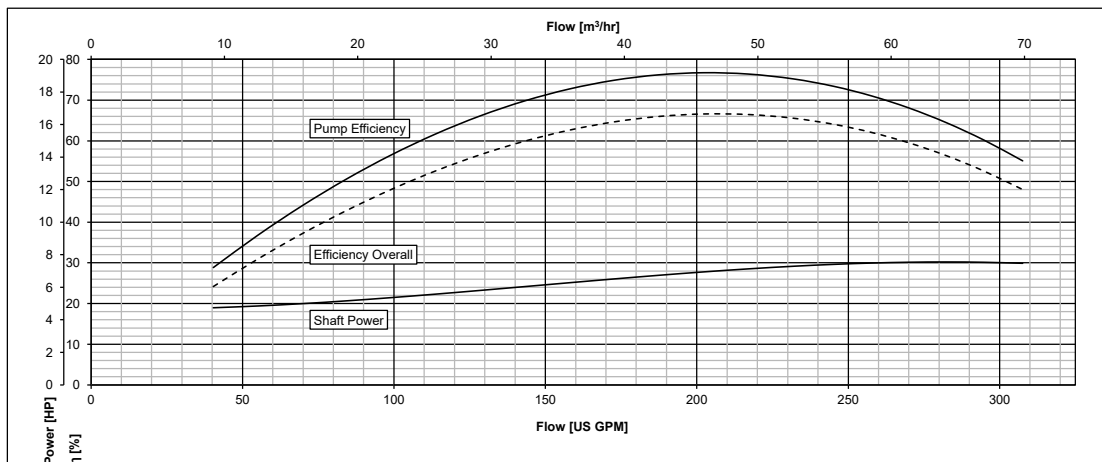
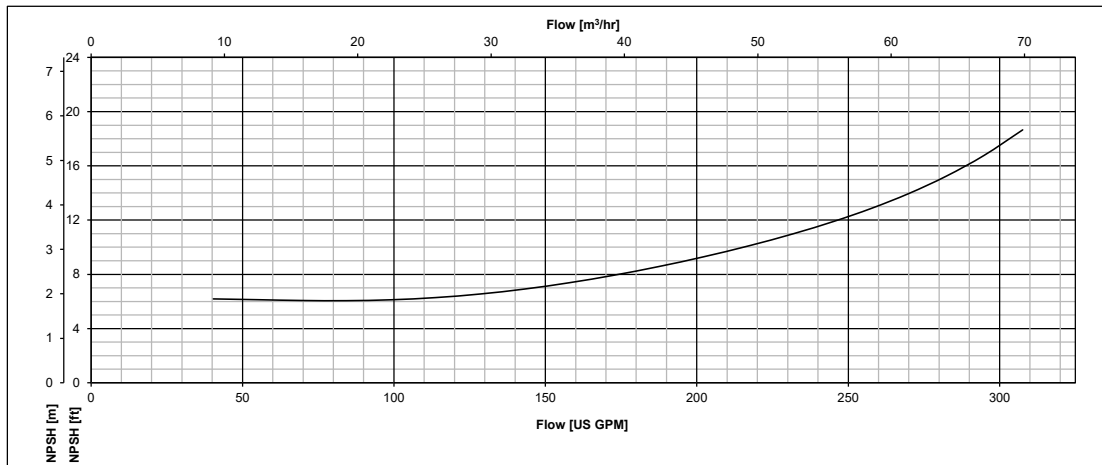
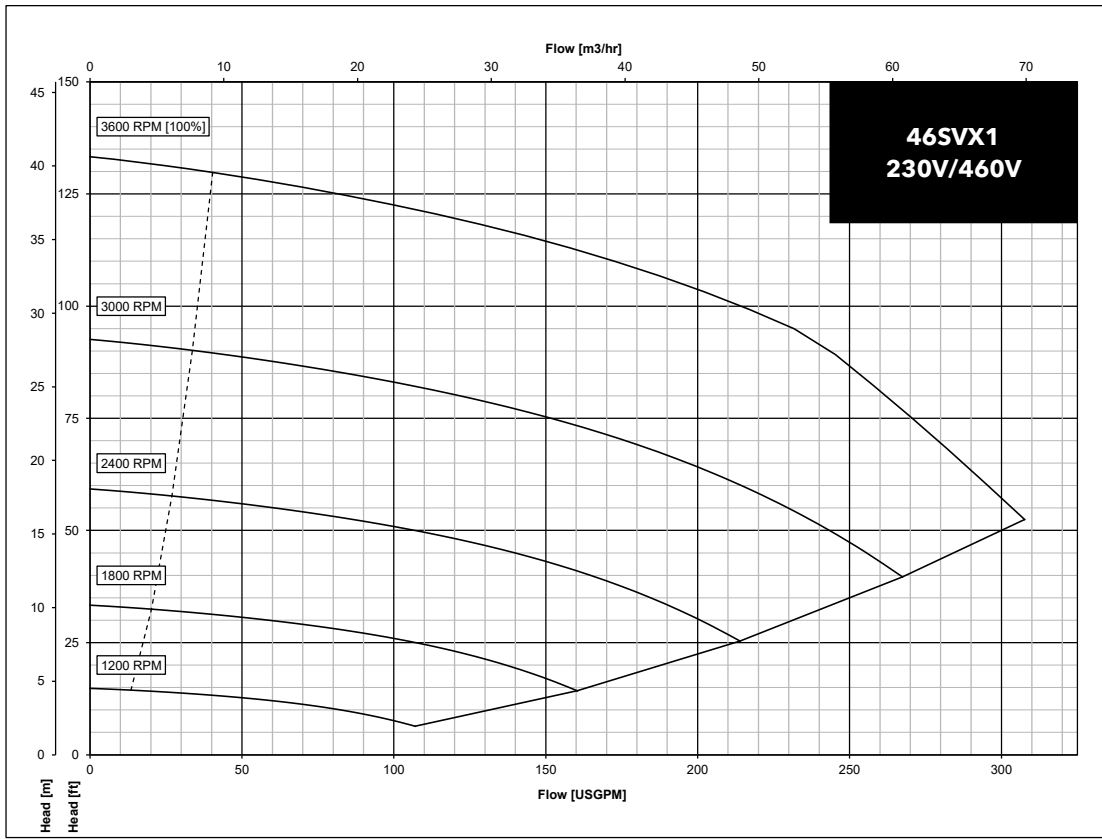

46SVX2/1 SERIES OPERATING CHARACTERISTICS

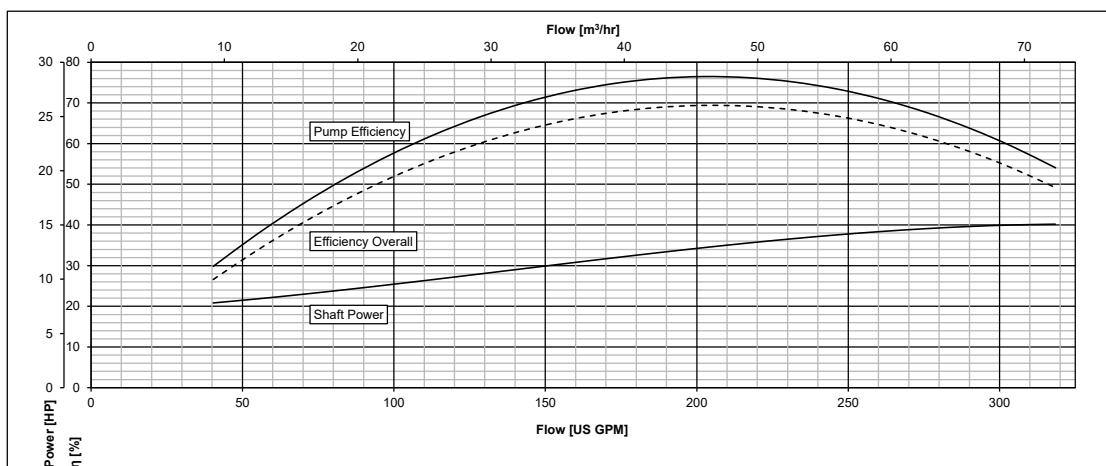
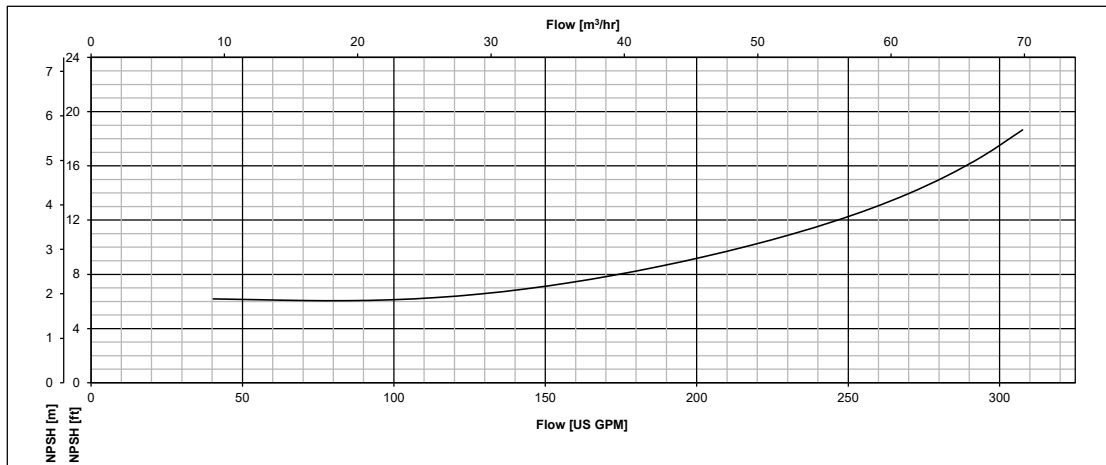
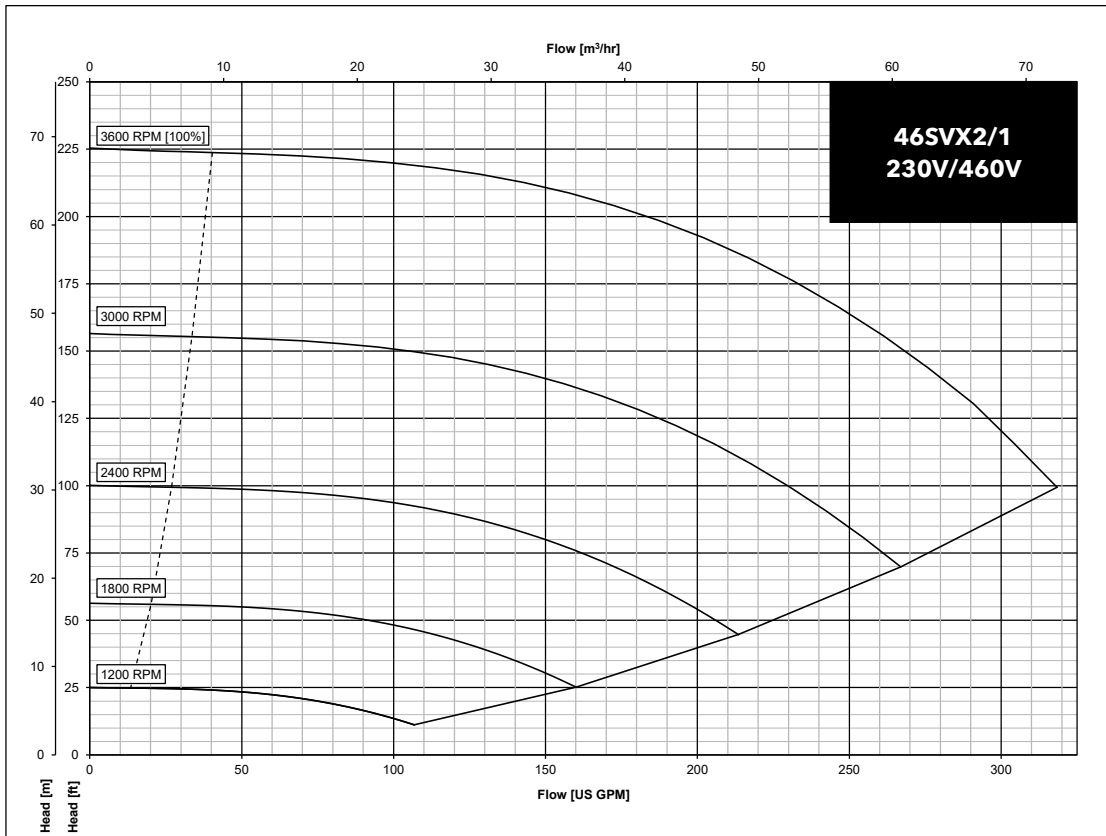

The performances are valid for liquid with density $\rho = 1.0 \text{ Kg/dm}^3$ and kinematic viscosity $\nu = 1 \text{ mm}^2/\text{sec}$.

46SVX03 SERIES OPERATING CHARACTERISTICS

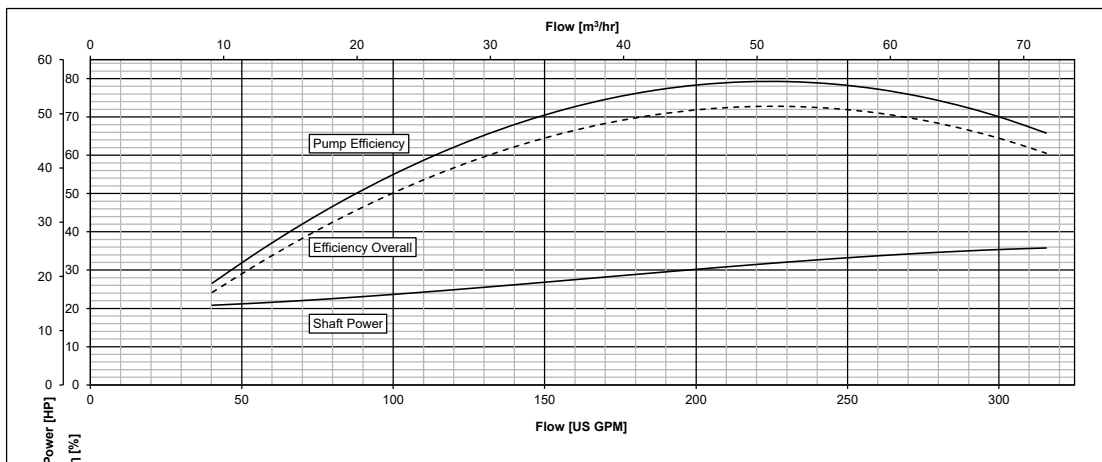
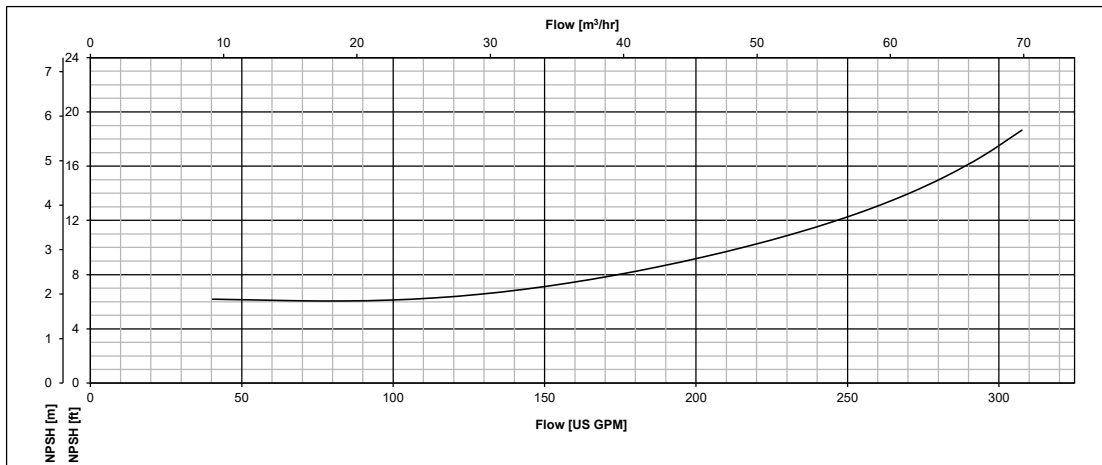
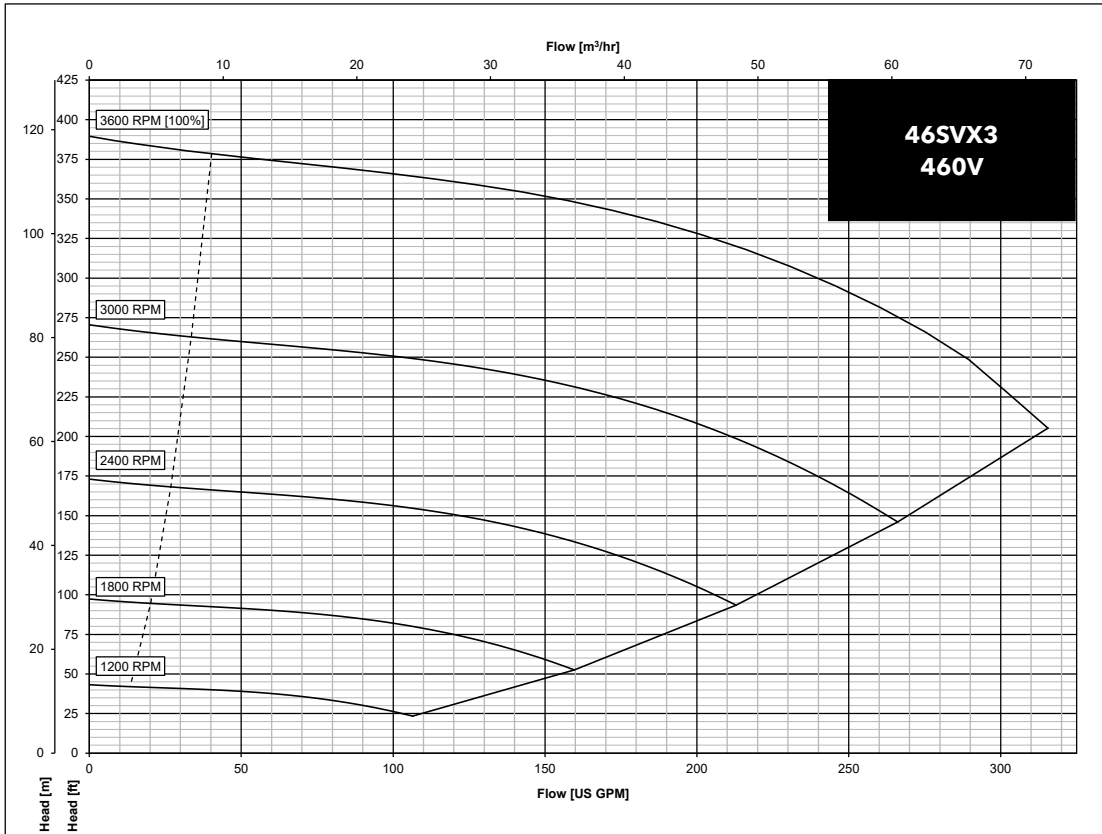

46SVX3/2 SERIES OPERATING CHARACTERISTICS

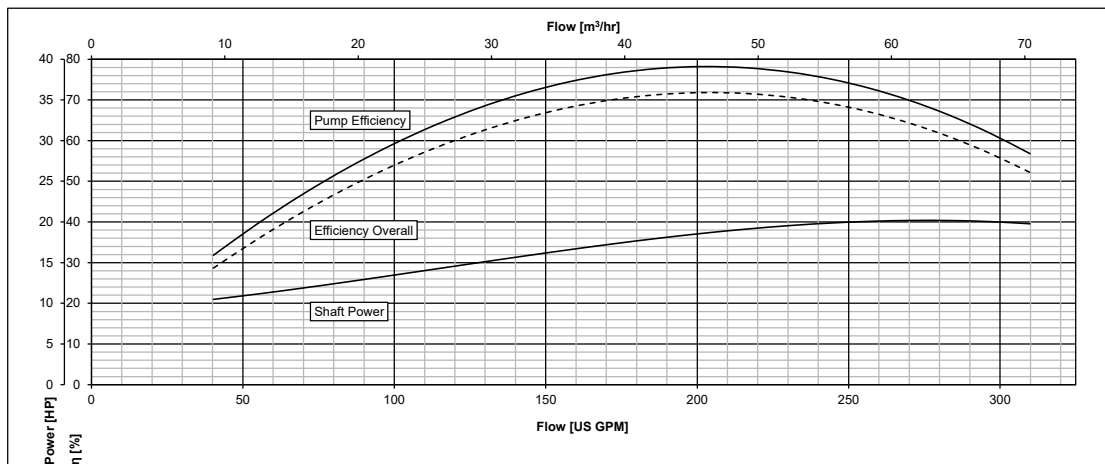
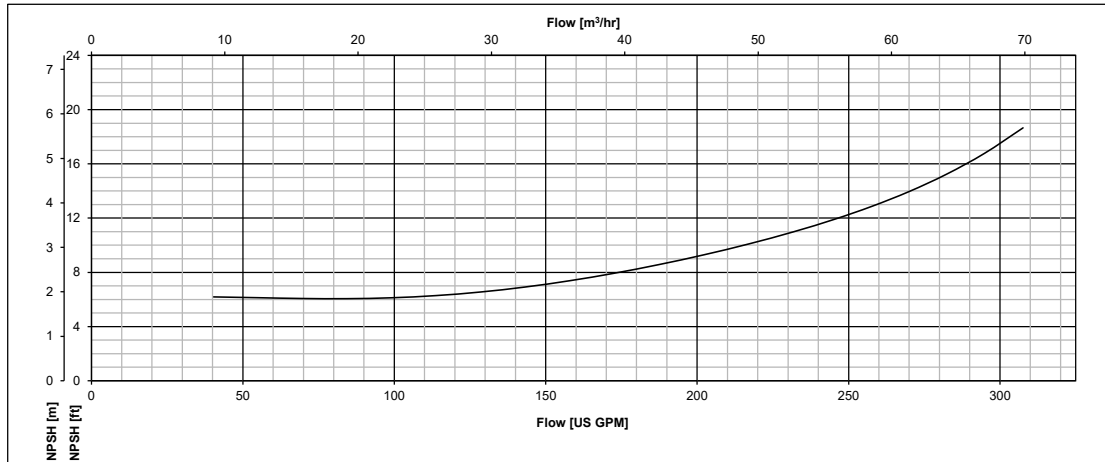
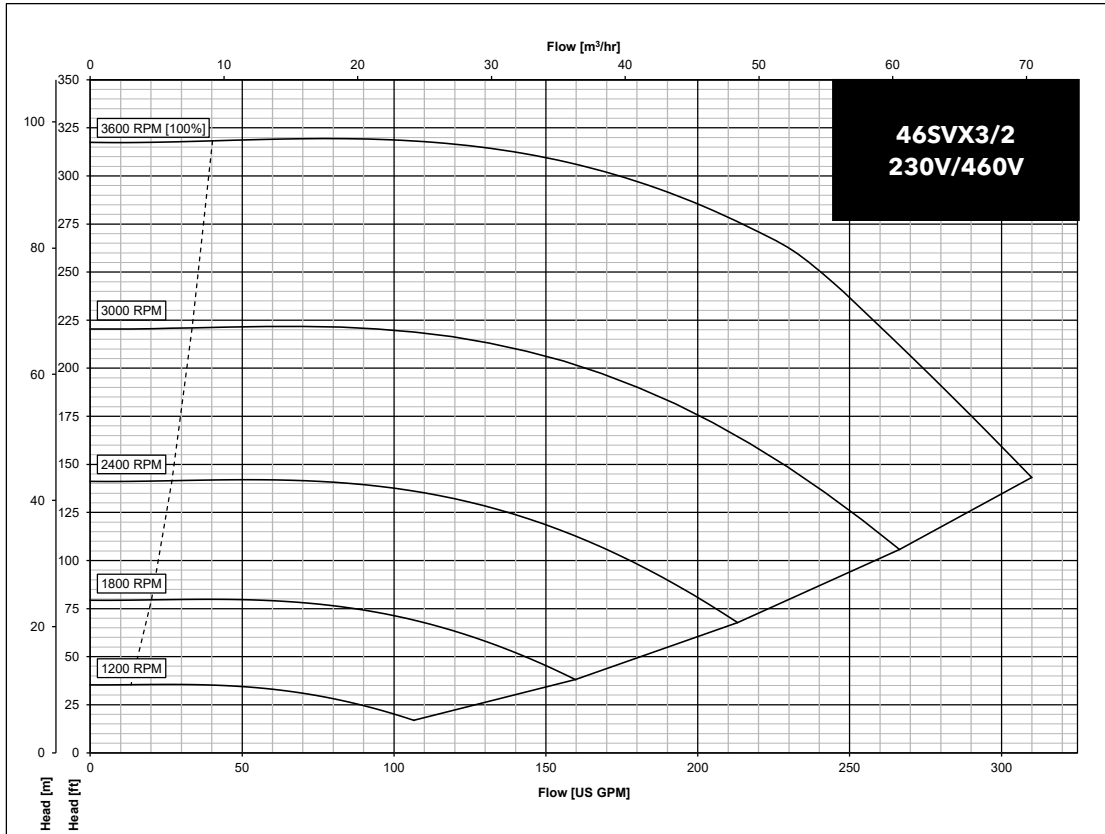

The performances are valid for liquid with density $\rho = 1.0 \text{ Kg/dm}^3$ and kinematic viscosity $\nu = 1 \text{ mm}^2/\text{sec}$.

46SVX4/1 SERIES OPERATING CHARACTERISTICS

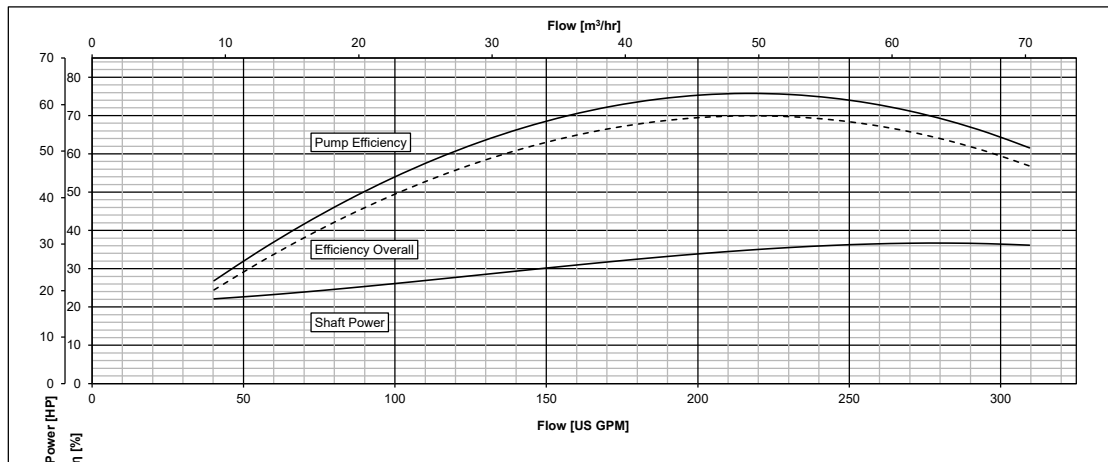
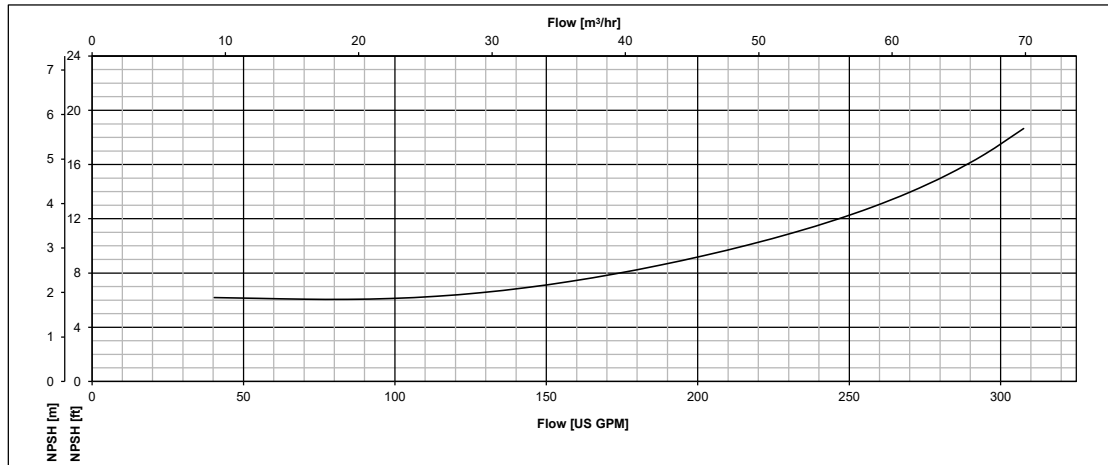
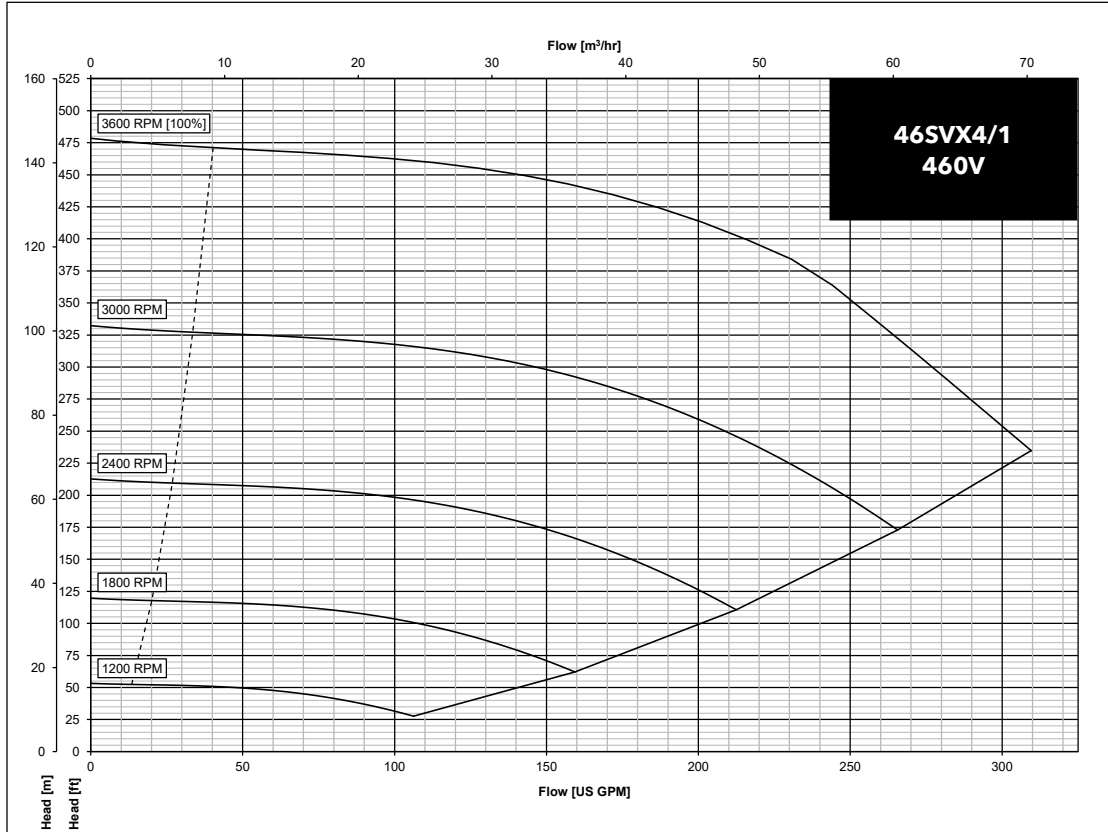

66 SVX SERIES DIMENSIONS AND WEIGHTS

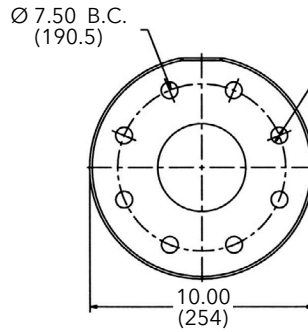
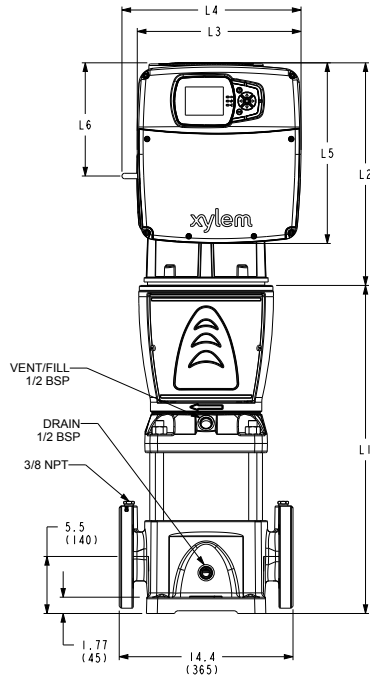
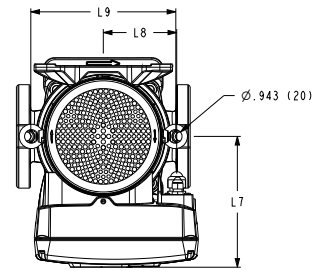
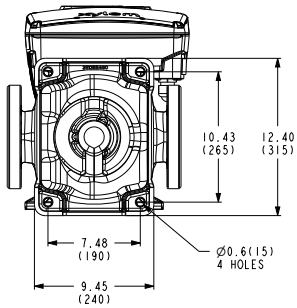

**Cast Iron
4" Class 125 F.F.**

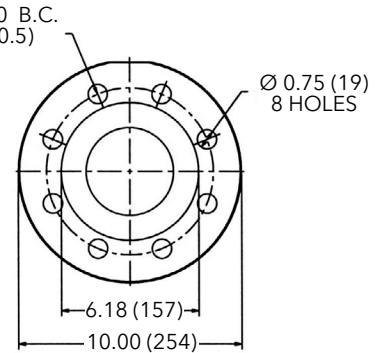

**316SS
4" Class 150 R.F.**

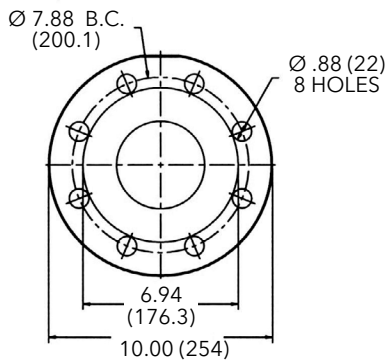

**Cast Iron
4" Class 250 R.F.**

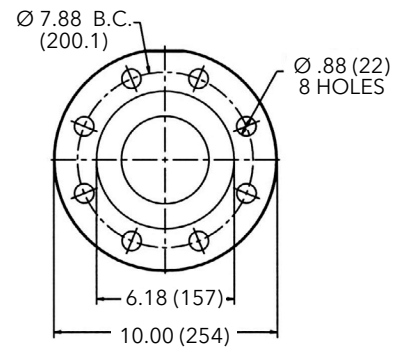

**316SS
4" Class 300 R.F.**

66SVX SERIES - 60 HZ, 3600 RPM TEFC ENCLOSURES

Pump Type Stages	Motor				Dimensions (in)									Weight (lbs.)		
	Voltage	HP	NEMA Frame "TEFC 3Ø"	Motor Type	L1	L2	L3	L4	L5	L6	L7	L8	L9		Motor	Pump/ Motor
66SVX-01	380-480	15	213TC	EXM213-215TC/4.150CH2	23.19	16.14	11.89	12.98	13.10	8.21	9.48	5.32	10.43	185	112	297
	200-240	15	254TC	EXM254-256TC/3.150DH2	23.19	19.29	14.25	15.16	15.72	9.57	12.17	6.59	12.50	185	148	333
66SVX-2/2	380-480	20	254TC	EXM254-256TC/4.200DH2	26.75	19.29	14.25	15.16	15.72	9.57	12.17	6.59	12.50	196	161	357
	200-240	20	254TC	EXM254-256TC/3.200DH2	26.75	19.29	14.25	15.16	15.72	9.57	12.17	6.59	12.50	196	161	357
66SVX-2/1	380-480	25	254TC	EXM254-256TC/4.250DH2	26.75	19.29	14.25	15.16	15.72	9.57	12.17	6.59	12.50	196	174	370
66SVX-02	380-480	30	254TC	EXM254-256TC/4.300DH2	28.31	19.29	14.25	15.16	15.72	9.57	12.17	6.59	12.50	210	187	397

66SVX01 SERIES OPERATING CHARACTERISTICS

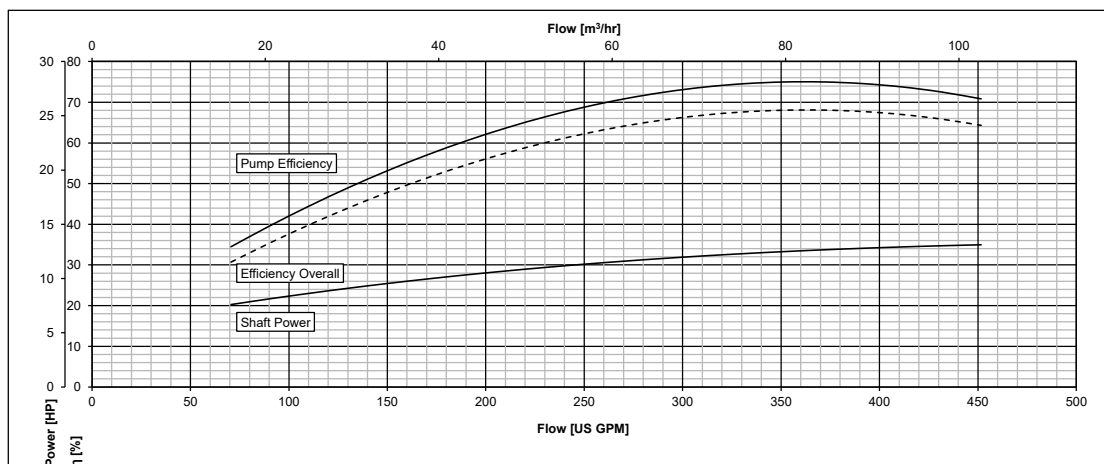
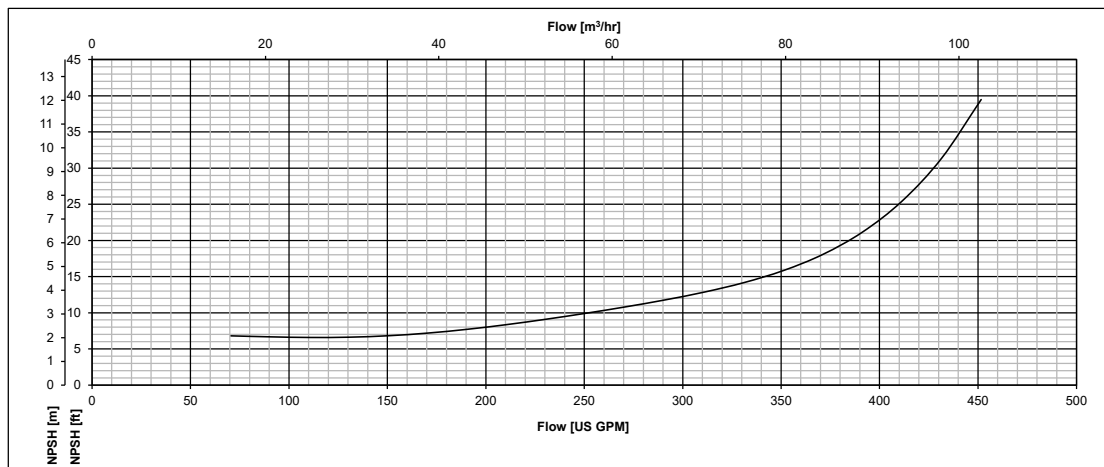
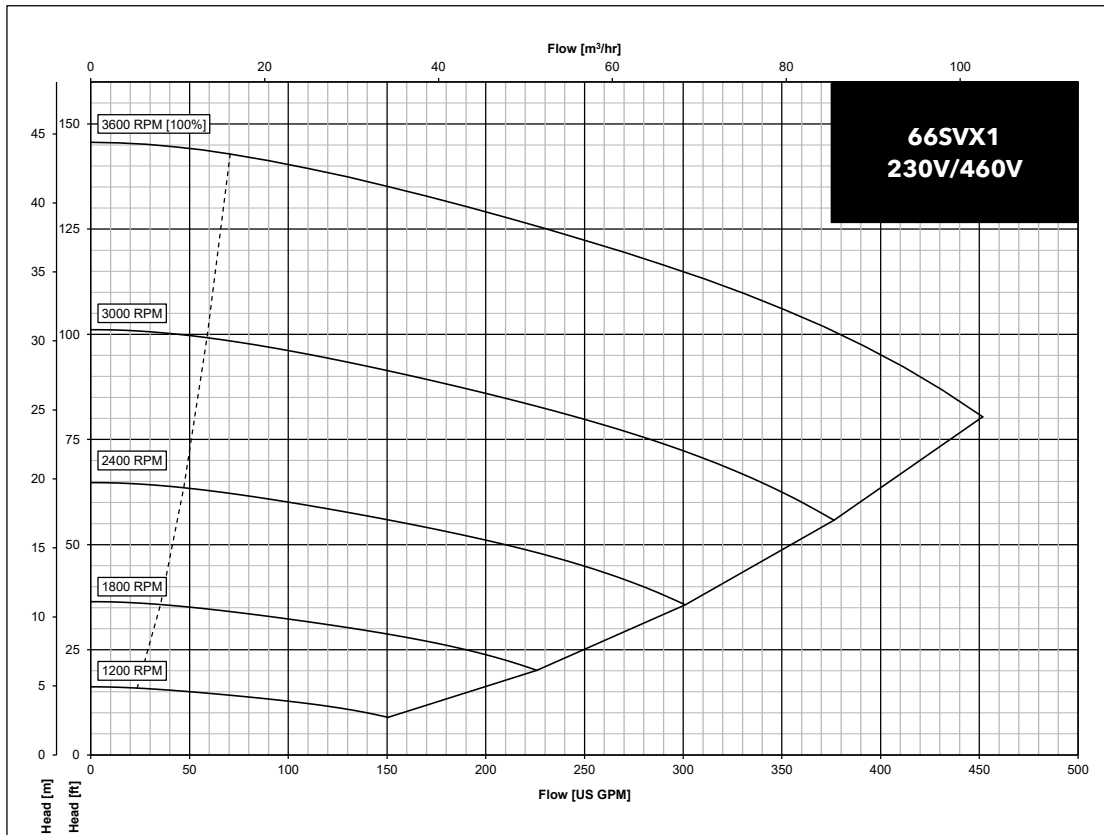

The performances are valid for liquid with density $\rho = 1.0 \text{ Kg/dm}^3$ and kinematic viscosity $\nu = 1 \text{ mm}^2/\text{sec}$.

66SVX2/2 SERIES OPERATING CHARACTERISTICS

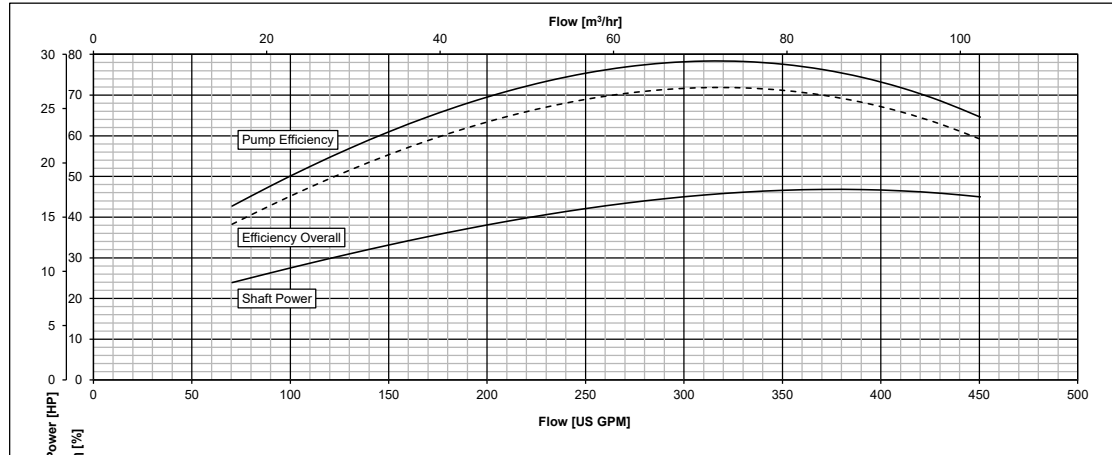
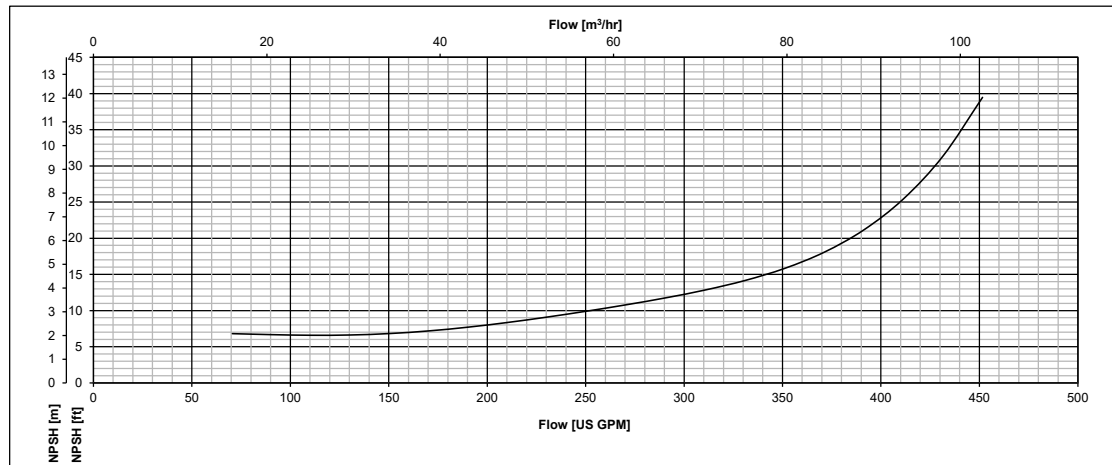
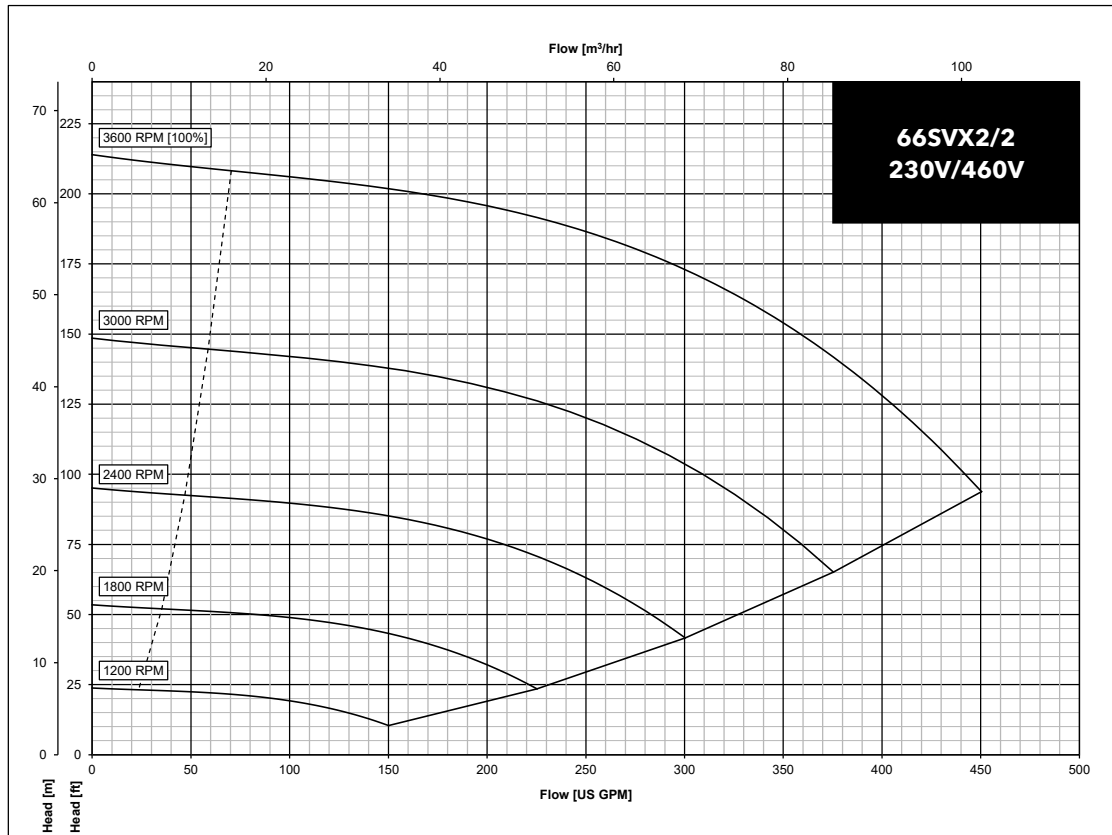

The performances are valid for liquid with density $\rho = 1.0 \text{ Kg/dm}^3$ and kinematic viscosity $\nu = 1 \text{ mm}^2/\text{sec}$.

66SVX2/1 SERIES OPERATING CHARACTERISTICS

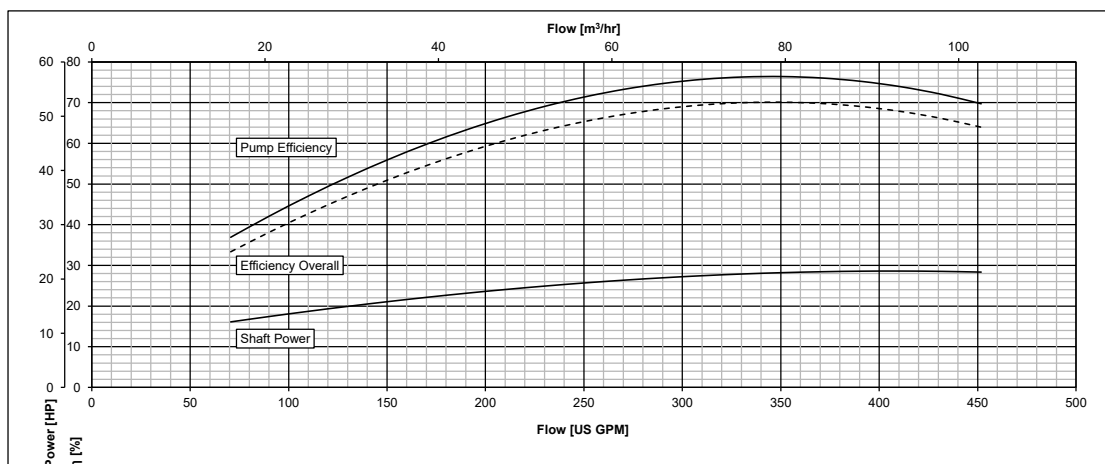
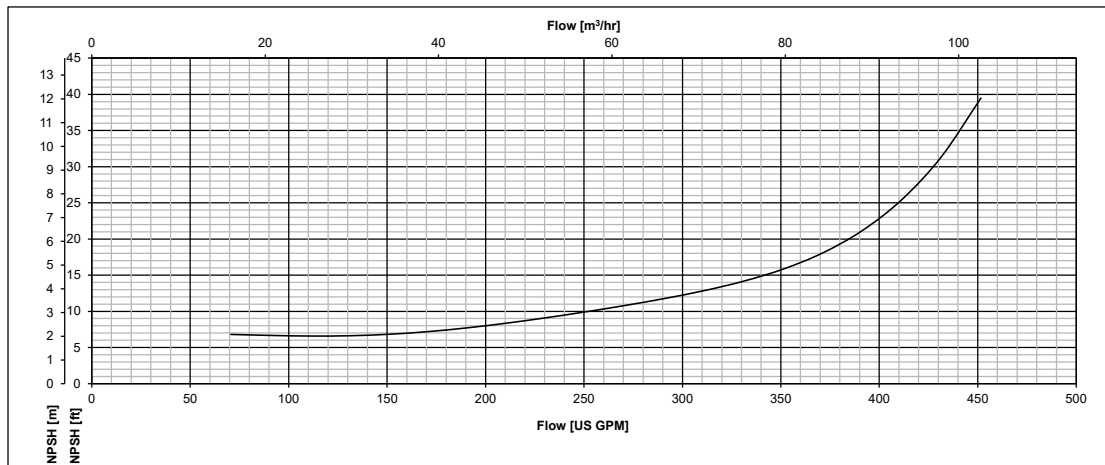
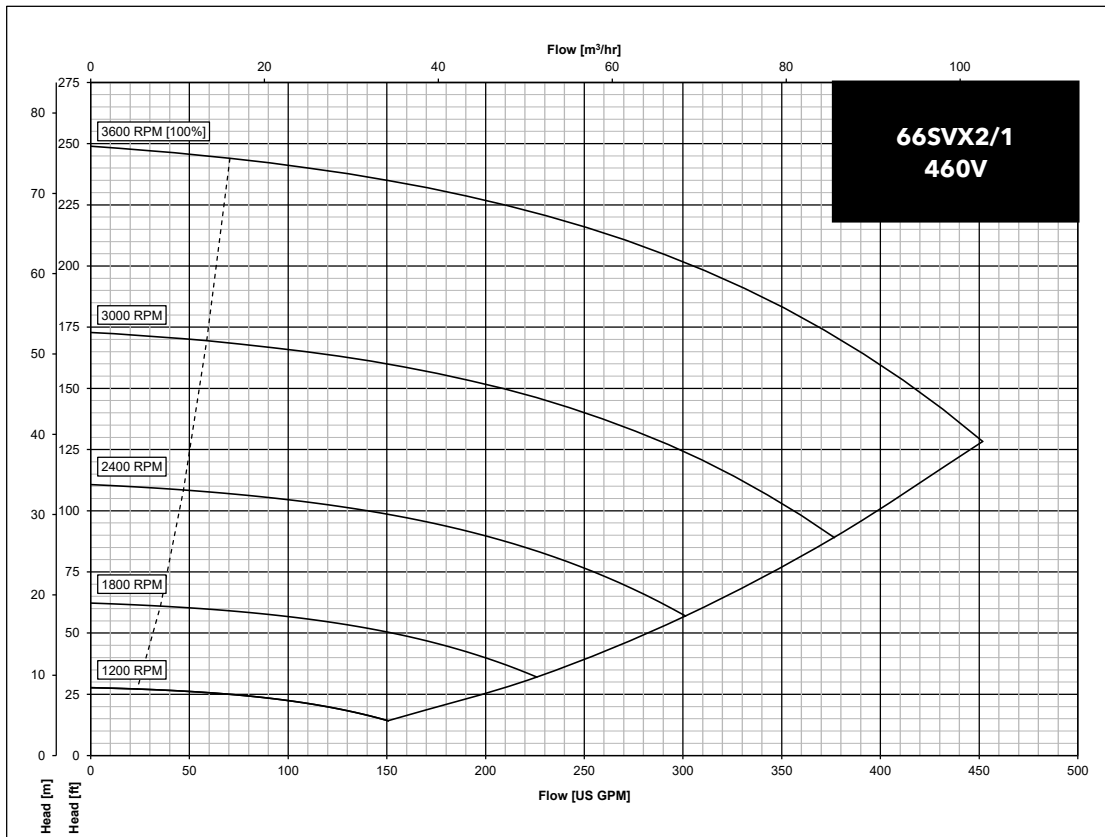

The performances are valid for liquid with density $\rho = 1.0 \text{ Kg/dm}^3$ and kinematic viscosity $\nu = 1 \text{ mm}^2/\text{sec}$.

66SVX02 SERIES OPERATING CHARACTERISTICS

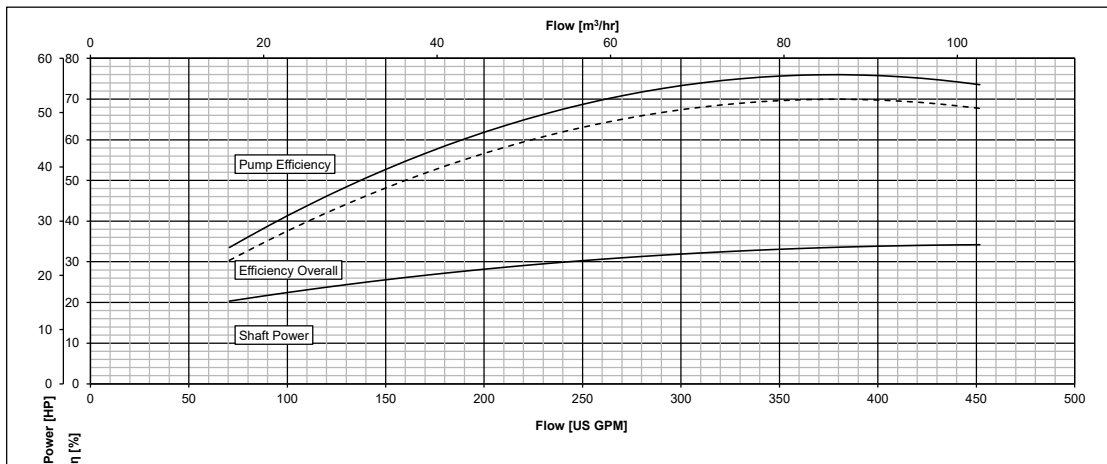
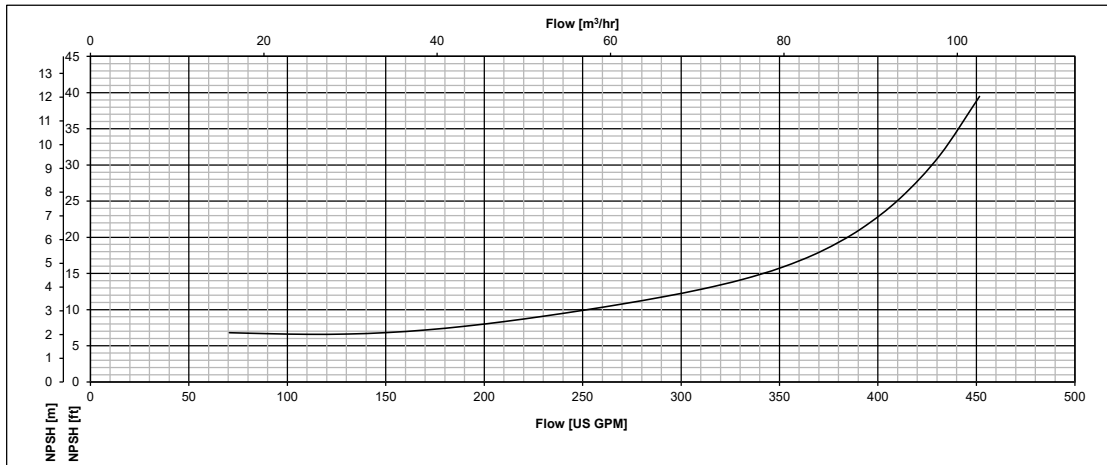
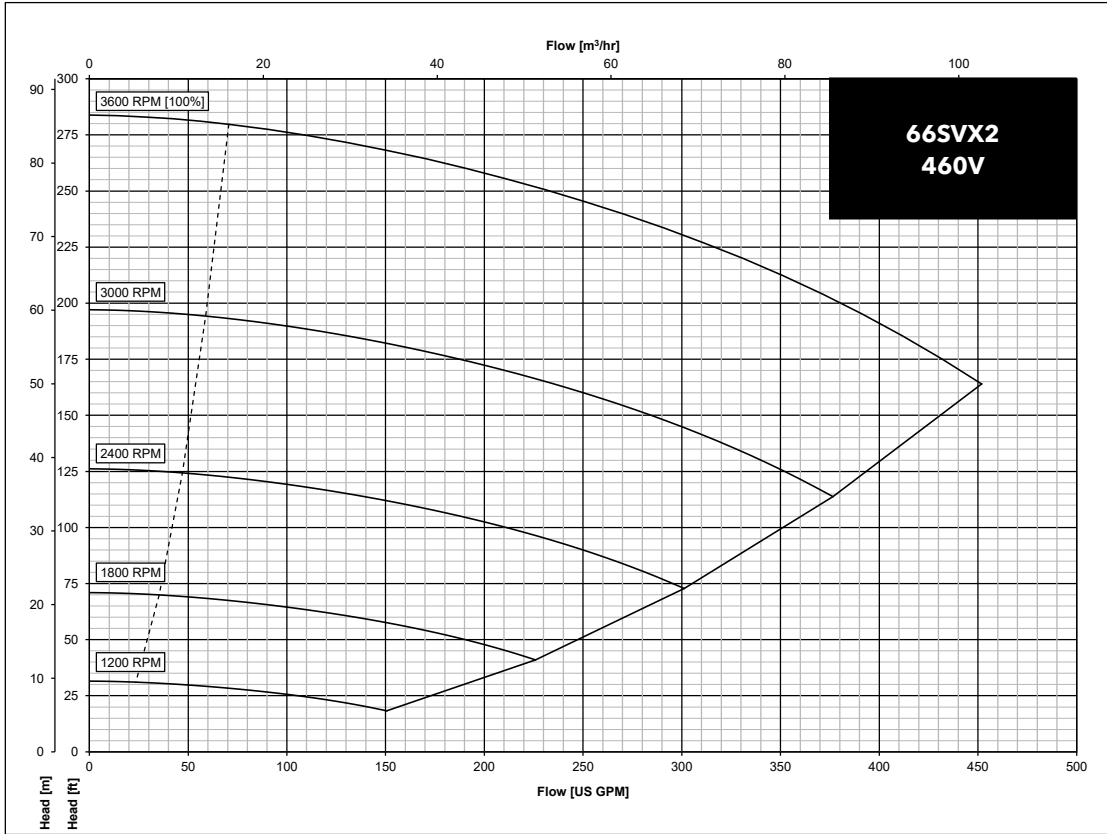

Commercial Water

92SVX SERIES DIMENSIONS AND WEIGHTS

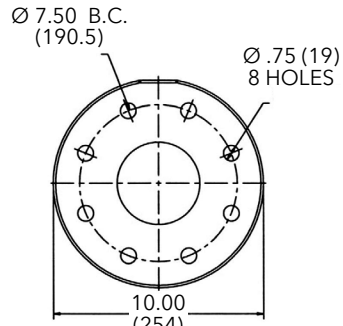
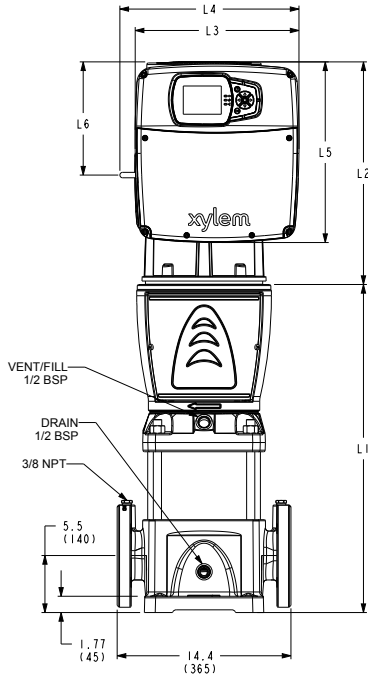
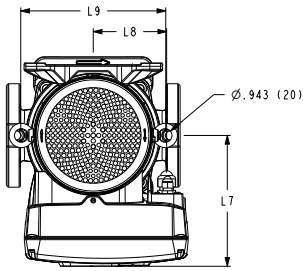
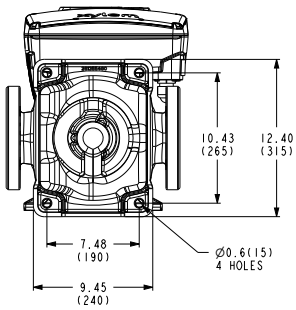

**Cast Iron
4" Class 125 R.F.**

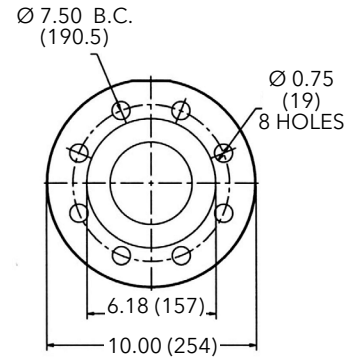

**316SS
4" Class 150 R.F.**

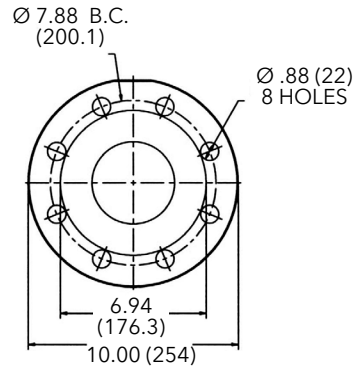

**Cast Iron
4" Class 250 R.F.**

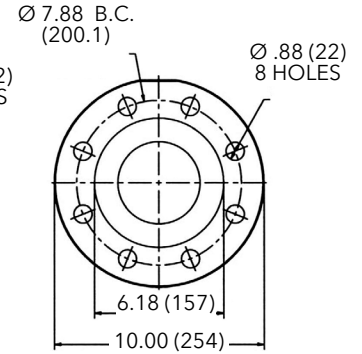

**316SS
4" Class 300 R.F.**

92SVX SERIES - 60 HZ, 3600 RPM TEFC ENCLOSURES

Pump Type Stages	Motor				Dimensions (in)									Weight (lbs.)		
	Voltage	HP	NEMA Frame	Motor Type	L1	L2	L3	L4	L5	L6	L7	L8	L9		Motor	Pump/Motor
			"TEFC 3Ø"													
92SVX-01	380-480	20	254TC	EXM254-256TC/4.200DH2	23.19	19.29	14.25	15.16	15.72	9.57	12.17	6.59	12.50	185	161	346
	200-240	20	254TC	EXM254-256TC/3.200DH2	23.19	19.29	14.25	15.16	15.72	9.57	12.17	6.59	12.50	185	161	346
92SVX-2/2	380-480	25	254TC	EXM254-256TC/4.250DH2	28.31	19.29	14.25	15.16	15.72	9.57	12.17	6.59	12.50	210	174	384
92SVX-2/1	380-480	30	254TC	EXM254-256TC/4.300DH2	28.31	19.29	14.25	15.16	15.72	9.57	12.17	6.59	12.50	210	187	397

92SVX01 SERIES OPERATING CHARACTERISTICS

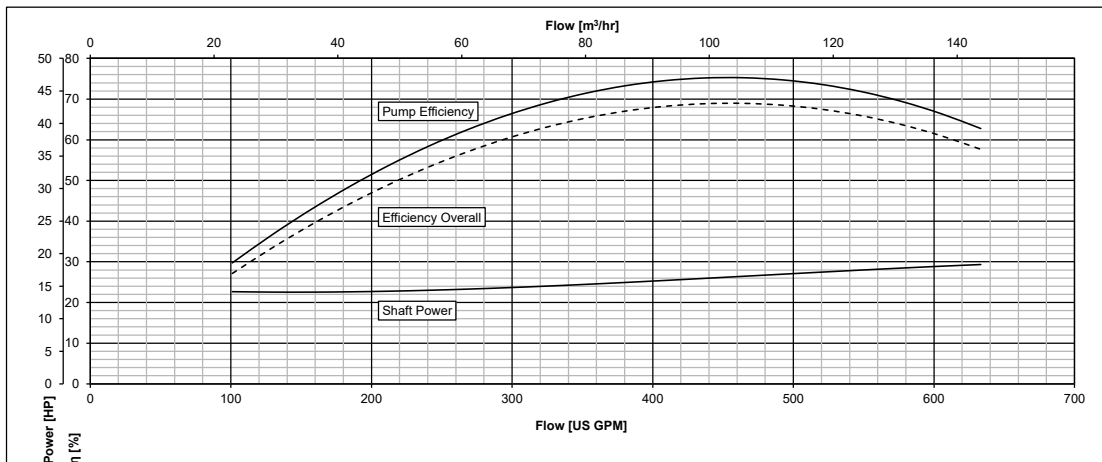
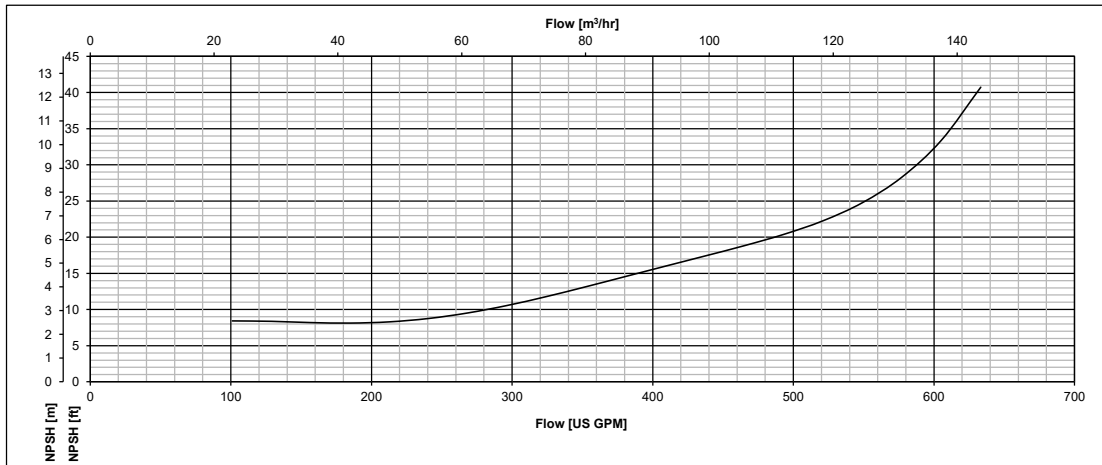
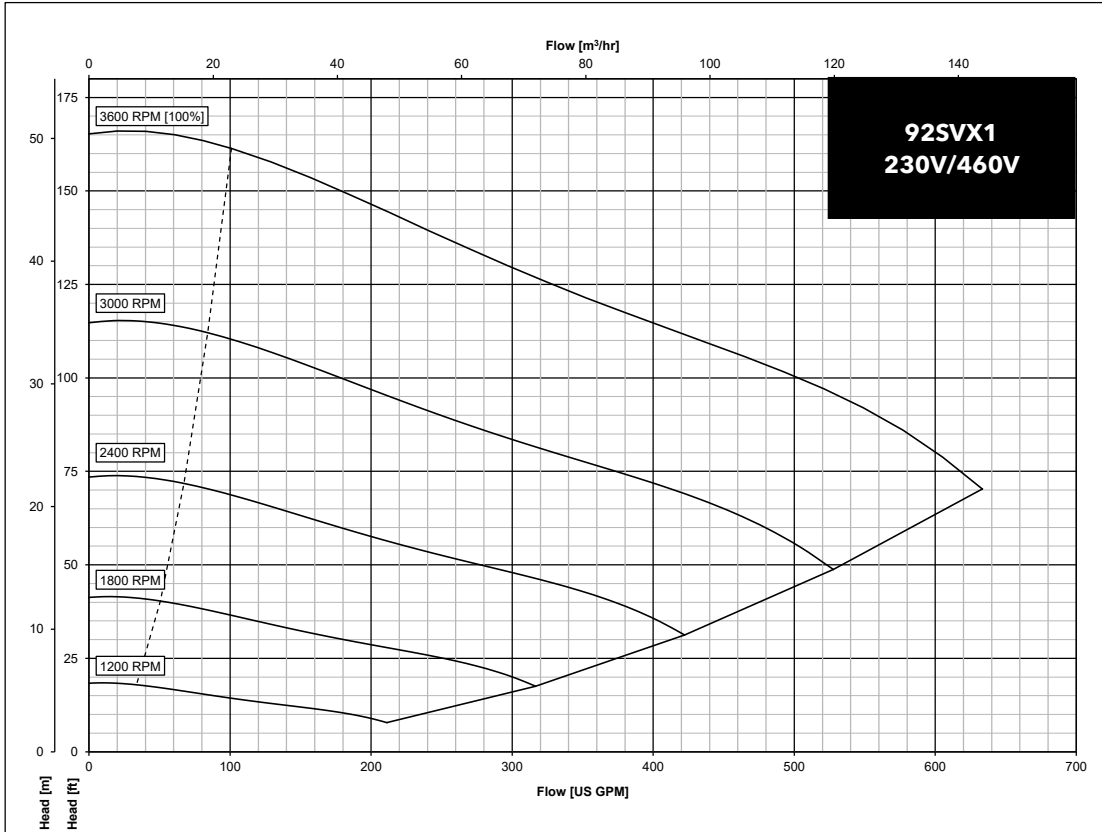

The performances are valid for liquid with density $\rho = 1.0 \text{ Kg/dm}^3$ and kinematic viscosity $\nu = 1 \text{ mm}^2/\text{sec}$.

92SVX2/2 SERIES OPERATING CHARACTERISTICS

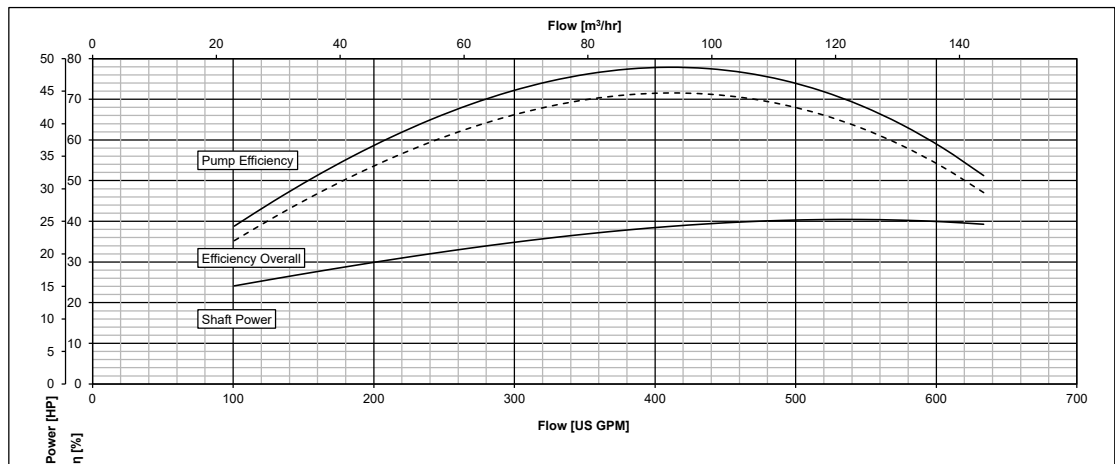
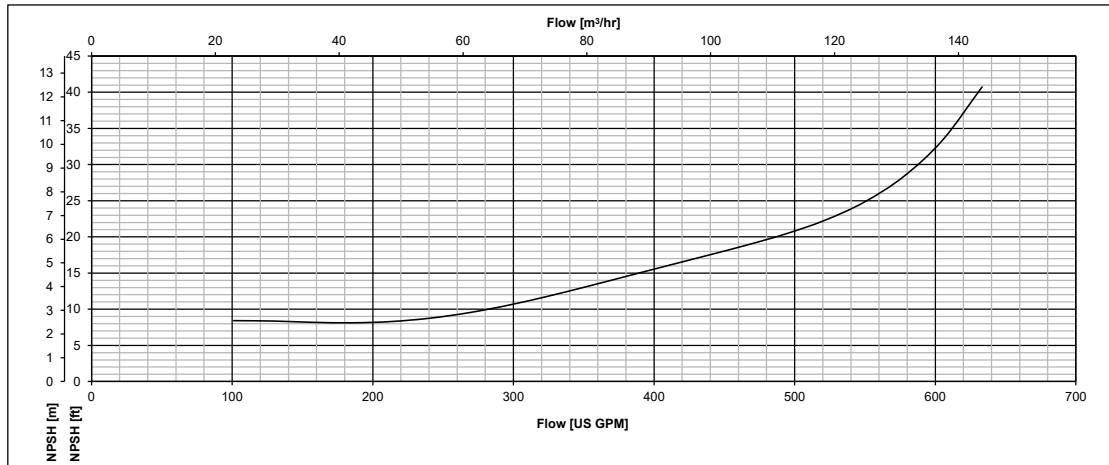
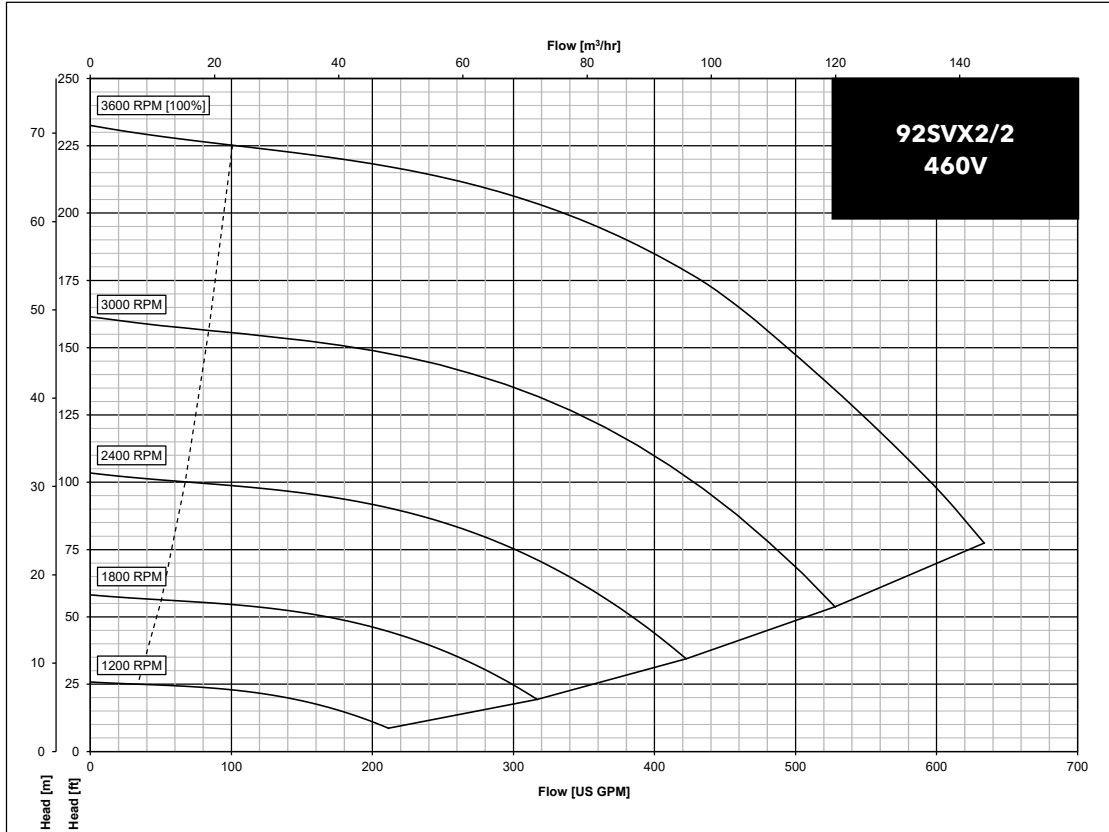

The performances are valid for liquid with density $\rho = 1.0 \text{ Kg/dm}^3$ and kinematic viscosity $\nu = 1 \text{ mm}^2/\text{sec}$.

92SVX2/1 SERIES OPERATING CHARACTERISTICS

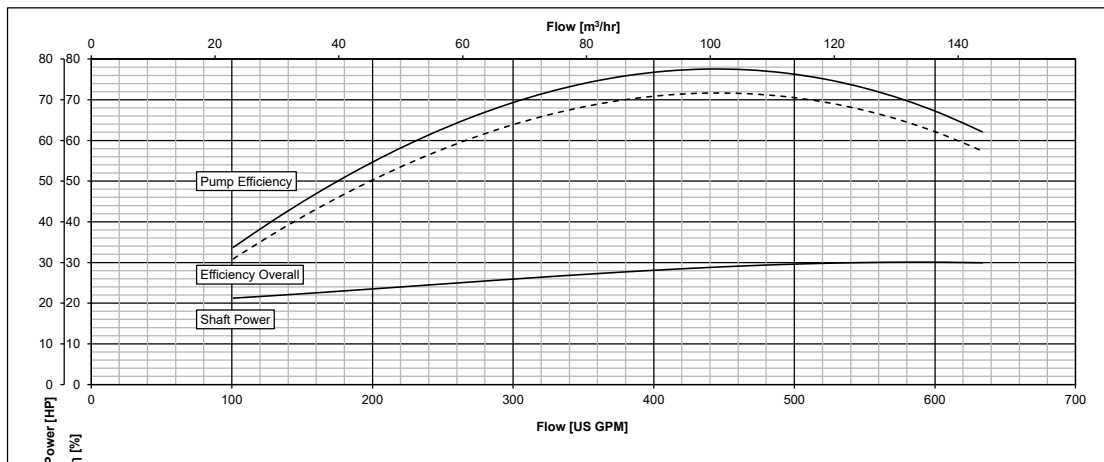
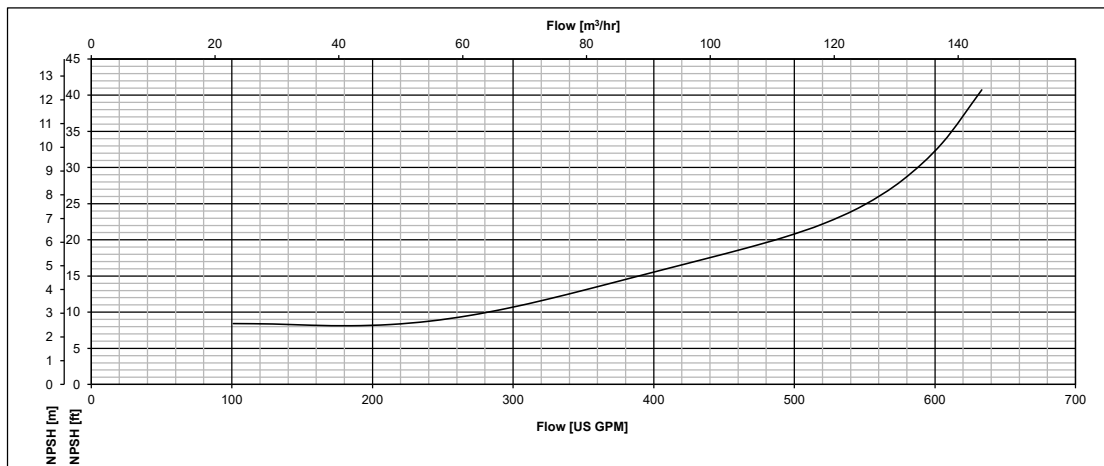
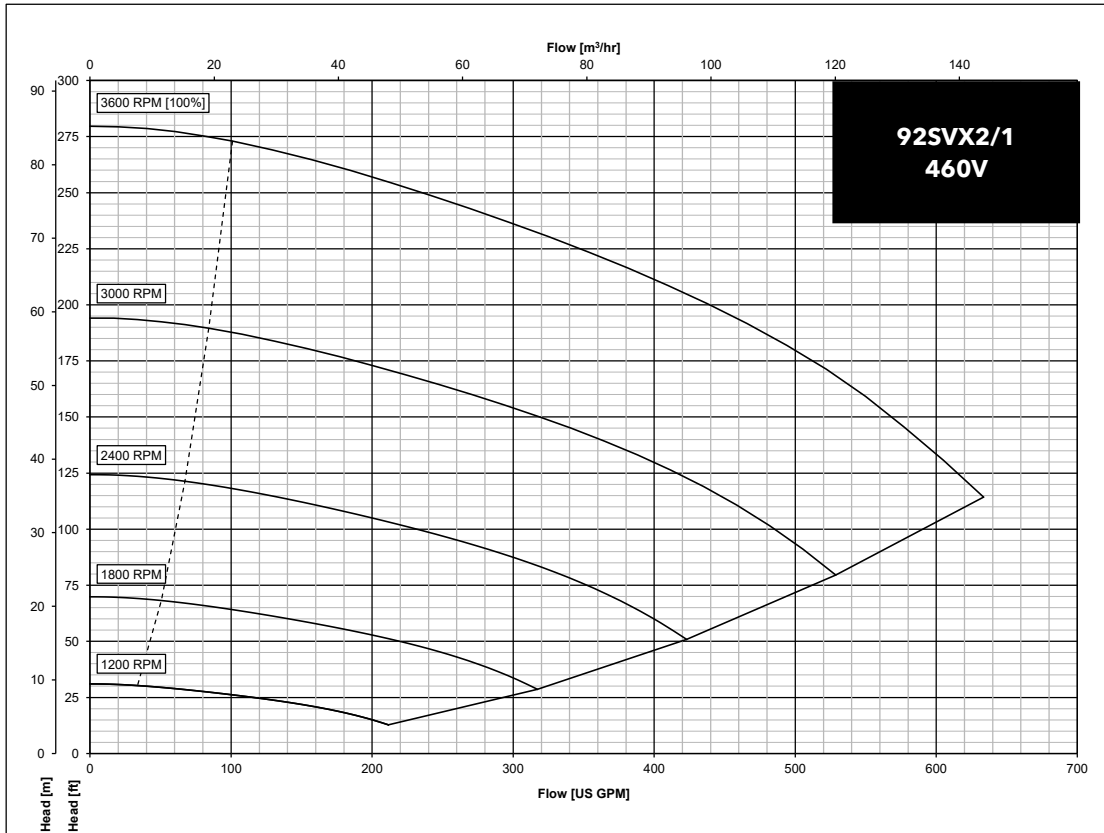

The performances are valid for liquid with density $\rho = 1.0 \text{ Kg/dm}^3$ and kinematic viscosity $\nu = 1 \text{ mm}^2/\text{sec}$.

125SVX SERIES DIMENSIONS AND WEIGHTS

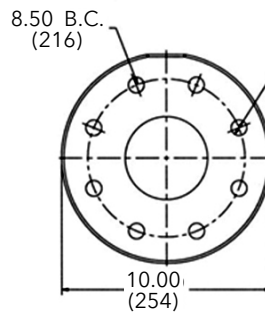
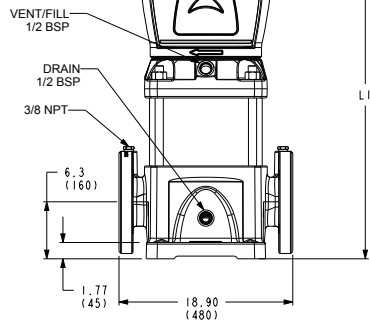
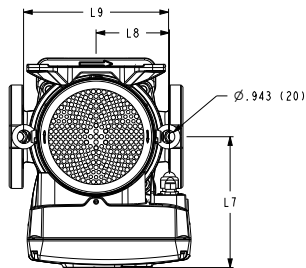
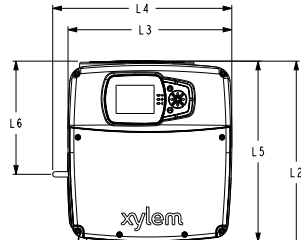
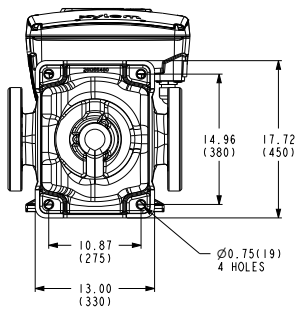

**Cast Iron
5" Class 125 F.F.**

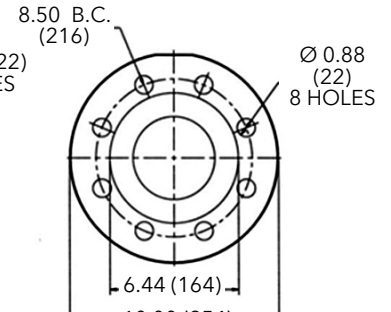

**316SS
5" Class 150 R.F.**

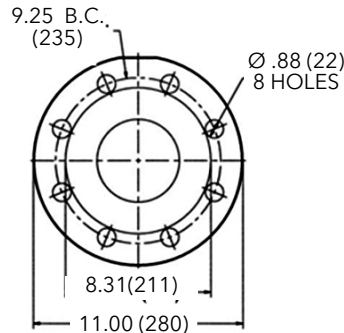

**Cast Iron
5" Class 250 R.F.**

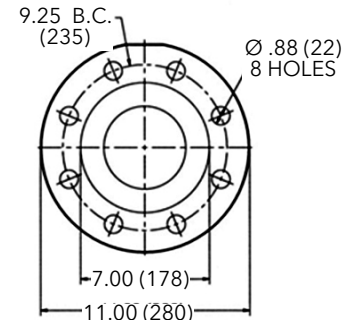

**316SS
5" Class 300 R.F.**

125SVX SERIES - 60 HZ, 3600 RPM TEFC ENCLOSURES

Pump Type Stages	Motor				Dimensions (in)									Weight (lbs.)		
	Voltage	HP	NEMA Frame	Motor Type	L1	L2	L3	L4	L5	L6	L7	L8	L9	"Pump Only"	Motor	Pump/ Motor
			"TEFC 3Ø"													
125SVX-1/0C	380-480	20	254TC	EXM254-256TC/4.200DH2	27.30	19.29	14.25	15.16	15.72	9.57	12.17	6.59	12.50	256	161	417
	200-240	20	254TC	EXM254-256TC/3.200DH2	27.30	19.29	14.25	15.16	15.72	9.57	12.17	6.59	12.50	256	161	417

125VX1/0C SERIES OPERATING CHARACTERISTICS

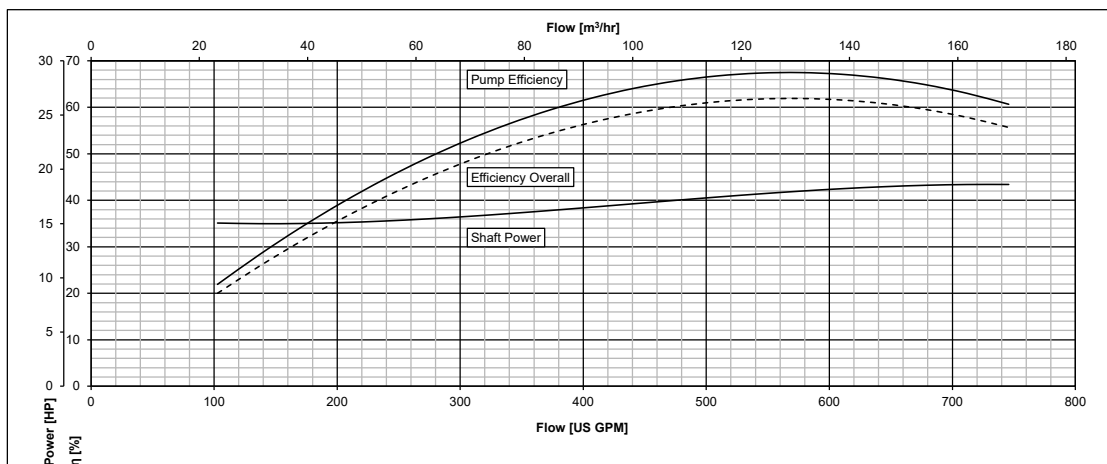
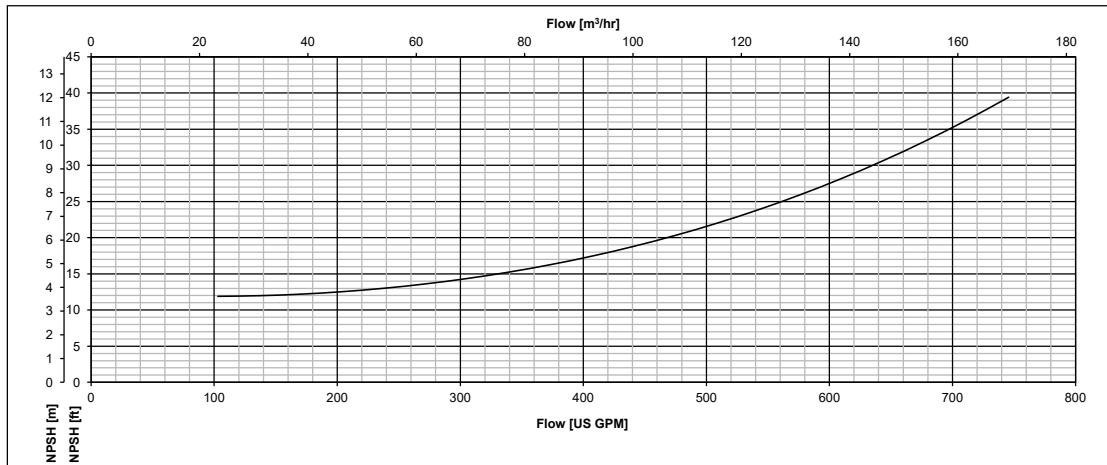
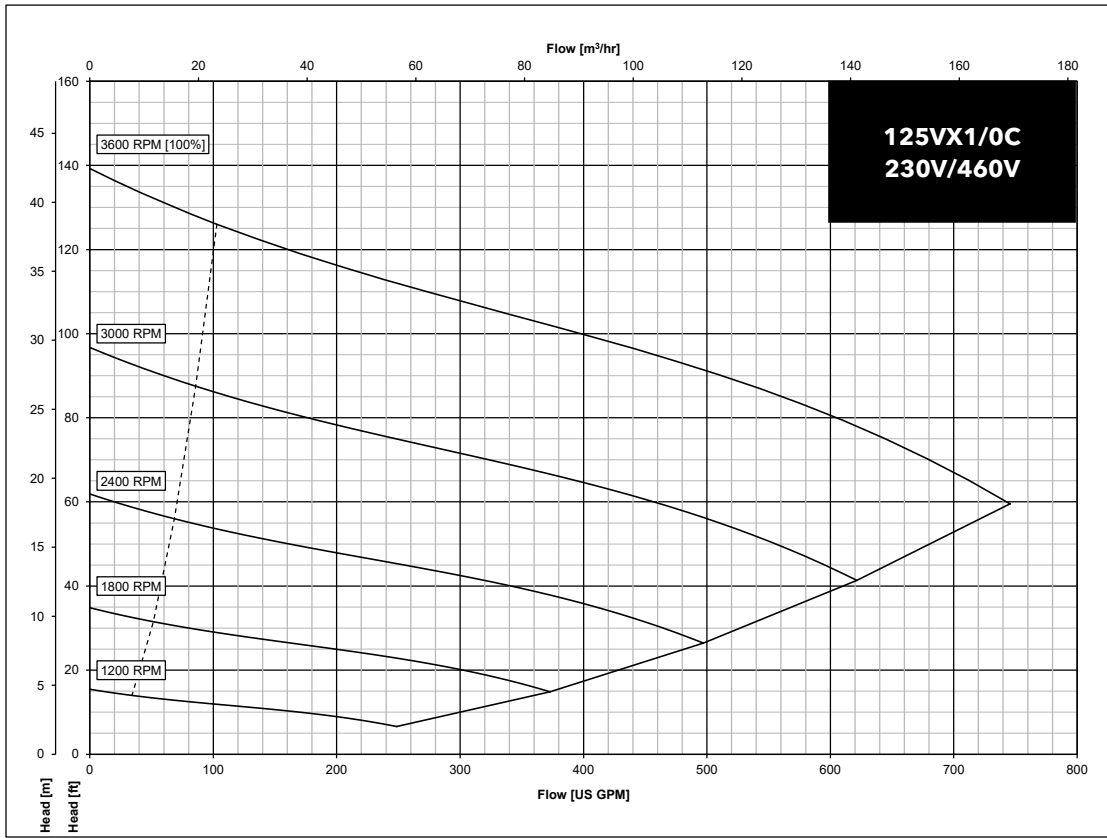

Commercial Water

NPSH

The minimum operating values that can be reached at the pump suction end are limited by the onset of cavitation.

Cavitation is the formation of vapor-filled cavities within liquids where the pressure is locally reduced to a critical value, or where the local pressure is equal to, or just below the vapor pressure of the liquid.

The vapor-filled cavities flow with the current and when they reach a higher pressure the vapor contained in the cavities condenses. The cavities collide, generating pressure waves that are transmitted to the walls. These, being subjected to stress cycles, gradually become deformed and yield due to fatigue. This phenomenon, characterized by a metallic noise produced by the hammering on the pipe walls, is called incipient cavitation.

The damage caused by cavitation may be magnified by electrochemical corrosion and a local rise in temperature due to the plastic deformation of the walls. The materials that offer the highest resistance to heat and corrosion are alloy steels, especially austenitic steel. The conditions that trigger cavitation may be assessed by calculating the total net suction head, referred to in technical literature with the acronym NPSH (Net Positive Suction Head).

The NPSH represents the total energy (expressed in feet) of the liquid measured at suction under conditions of incipient cavitation, excluding the vapor pressure (expressed in feet) that the liquid has at the pump inlet.

A margin above the NPSH_r is necessary in order to achieve the pump's published performance and an adequate service life.

To find the static height (h_z) at which to install the machine under safe conditions, the following formula must be verified:

$$h_p + h_z \geq (\text{NPSH}_r + 2 \text{ feet}) + h_f + h_{pv}$$

where:

h_p is the absolute pressure applied to the free liquid surface in the suction tank, expressed in feet of liquid; h_p is the quotient between the barometric pressure and the specific weight of the liquid.

h_z is the suction lift between the pump axis and the free liquid surface in the suction tank, expressed in feet; h_z is negative when the liquid level is lower than the pump axis.

h_f is the flow resistance in the suction line and its accessories, such as: fittings, foot valve, gate valve, elbows, etc.

h_{pv} is the vapor pressure of the liquid at the operating temperature, expressed in feet of the liquid. h_{pv} is the quotient between the P_v vapor pressure and the liquid's specific weight.

0.5 is the safety factor.

The maximum possible suction head for installation depends on the value of the atmospheric pressure (i.e. the elevation above sea level at which the pump is installed) and the temperature of the liquid.

To help the user, with reference to water temperature (40°F) and to the elevation above sea level, the following tables show the drop in hydraulic pressure head in relation to the elevation above sea level, and the suction loss in relation to temperature.

Water Temperature (°C)	68	104	140	176	194	230	248
Suction Loss (ft)	-7	2.3	6.6	16.4	24.3	50.5	70.5

Elevation Above Sea Level (ft)	1600	3300	4900	6500	8200	9800
Suction Loss (ft)	1.8	3.6	5.4	7.2	9.0	10.8

To reduce it to a minimum, especially in cases of high suction head (over 13 - 16 feet) or within the operating limits with high flow rates, we recommend using a suction line having a larger diameter than that of the pump's suction port. It is always a good idea to position the pump as close as possible to the liquid to be pumped.

TECHNICAL DATA - WATER PROPERTY CHART

Temp °F	Temp °C	Specific Volume	Specific Gravity			Weight (lb/cubic ft)	Vapor Pressure (psi Abs)
		(Cubic ft/lb)	@ 39.2°F	@ 60°F	@ 68°F		
32	0.0	0.01602	1.000	1.001	1.002	62.42	0.088
35	1.7	0.01602	1.000	1.001	1.002	62.42	0.100
40	4.4	0.01602	1.000	1.001	1.002	62.42	0.122
50	10.0	0.01603	0.999	1.001	1.002	62.38	0.178
60	15.6	0.01604	0.999	1.000	1.001	62.34	0.256
70	21.1	0.01606	0.998	0.999	1.000	62.27	0.363
80	26.7	0.01608	0.996	0.998	0.999	62.19	0.507
90	32.2	0.0161	0.995	0.996	0.997	62.11	0.698
100	37.8	0.01613	0.993	0.994	0.995	62.00	0.949
120	48.9	0.0162	0.989	0.990	0.991	61.73	1.692
140	60.0	0.01629	0.983	0.985	0.986	61.39	2.889
160	71.1	0.01639	0.977	0.979	0.979	61.01	4.741
180	82.2	0.01651	0.970	0.972	0.973	60.57	7.510
200	93.3	0.01663	0.963	0.964	0.966	60.13	11.526
212	100.0	0.01672	0.958	0.959	0.960	59.81	14.696
220	104.4	0.01677	0.955	0.956	0.957	59.63	17.186
240	115.6	0.01692	0.947	0.948	0.949	59.10	24.97
260	126.7	0.01709	0.938	0.939	0.940	58.51	35.43
280	137.8	0.01726	0.928	0.929	0.930	58.00	49.20
300	148.9	0.01745	0.918	0.919	0.920	57.31	67.01
320	160.0	0.01756	0.908	0.909	0.910	56.66	89.66
340	171.1	0.01787	0.896	0.898	0.899	55.96	118.01
360	182.2	0.01811	0.885	0.886	0.887	55.22	153.04
380	193.3	0.01836	0.873	0.874	0.875	54.47	195.77
400	204.4	0.01864	0.859	0.860	0.862	53.65	247.31
420	215.6	0.01894	0.846	0.847	0.848	52.80	308.83
440	226.7	0.01926	0.832	0.833	0.834	51.92	381.59
460	237.8	0.0196	0.817	0.818	0.819	51.02	466.9
480	248.9	0.02	0.801	0.802	0.803	50.00	566.1
500	260.0	0.0204	0.785	0.786	0.787	49.02	680.8
520	271.1	0.0209	0.765	0.766	0.767	47.85	812.4
540	282.2	0.0215	0.746	0.747	0.748	46.51	962.5
560	293.3	0.0221	0.726	0.727	0.728	45.30	1133.1
580	304.4	0.0228	0.703	0.704	0.704	43.90	1325.8
600	315.6	0.0236	0.678	0.679	0.680	42.30	1542.9
620	326.7	0.0247	0.649	0.650	0.650	40.50	1786.6
640	337.8	0.026	0.617	0.618	0.618	38.50	2059.7
660	348.9	0.0278	0.577	0.577	0.578	36.00	2365.4
680	360.0	0.0305	0.525	0.526	0.527	32.80	2708.1
700	371.1	0.0369	0.434	0.435	0.435	27.10	3093.7

Commercial Water

VOLUMETRIC CAPACITY

Litres per minute l/min	Cubic metres per hour m ³ /h	Cubic feet per hour ft ³ /h	Cubic feet per minute ft ³ /min	Imp. gal. per minute Imp. gal./min	US gal. per minute US gal./min
1,000	0,0600	2,1189	0,0353	0,2200	0,2640
16,6670	1,0000	35,3147	0,5886	3,6660	4,4030
0,4720	0,0283	1,0000	0,0167	0,1040	0,1250
28,3170	1,6990	60,0000	1,0000	6,2290	7,4800
4,5460	0,2728	9,6326	0,1605	1,0000	1,2010
3,7850	0,2271	8,0209	0,1337	0,8330	1,0000
0,1100	0,0066	0,2339	0,0039	0,0240	0,0290

PRESSURE AND HEAD

Newtons per square metre N/m ²	Kilopascal kPa	Bar bar	Pound Force per square inch psi	Metre of Water m H ₂ O	Millimetre of Mercury mm Hg
1,0000	0,0010	1 x 10 ⁵	1,45 x 10 ⁻⁴	1,02 x 10 ⁻⁴	0,0075
1000,0000	1,0000	0,0100	0,1450	0,1020	7,5000
100000,0000	100,0000	1,0000	14,5000	10,2000	750,1000
98067,0000	98,0700	0,9810	14,2200	10,0000	735,6000
6895,0000	6,8950	0,0690	1,0000	0,7030	51,7200
2984,0000	2,9840	0,0300	0,4330	0,3050	22,4200
9789,0000	9,7890	0,0980	1,4200	1,0000	73,4200
133,3000	0,1330	0,0013	0,0190	0,0140	1,0000
3386,0000	3,3860	0,0338	0,4910	0,3450	25,4000

LENGTH

Millimetre mm	Centimetre cm	Metre m	Inch in	Foot ft	Yard yd
1,0000	0,1000	0,0010	0,0394	0,0033	0,0011
10,0000	1,0000	0,0100	0,3937	0,0328	0,0109
1000,0000	100,0000	1,0000	39,3701	3,2808	1,0936
25,4000	2,5400	0,0254	1,0000	0,0833	0,0278
304,8000	30,4800	0,3048	12,0000	1,0000	0,3333
914,4000	91,4400	0,9144	36,0000	3,0000	1,0000

VOLUME

Cubic Metre m ³	Litre litre	Millilitre ml	Imp. Gallon imp. gal.	US Gallon US gal.	Cubic Foot ft ³
1,0000	1000,0000	1 x 10 ⁶	220,0000	264,2000	35,3147
0,0010	1,0000	1000,0000	0,2200	0,2642	0,0353
1 x 10 ⁻⁶	0,0010	1,0000	2,2 x 10 ⁻⁴	2,642 x 10 ⁻⁴	3,53 x 10 ⁻⁵
0,0045	4,5460	4546,0000	1,0000	1,2010	0,1605
0,0038	3,7850	3785,0000	0,8327	1,0000	0,1337
0,0283	28,3170	28317,0000	6,2288	7,4805	1,0000

TECHNICAL DATA - COMPATABILITY CHART FOR MATERIALS IN CONTACT WITH MOST COMMONLY USED LIQUIDS

Liquid	Concentration (%)	Temperature Min/Max °F	Specific Weight (lb/in ³)	SV 1, 3, 5, 10, 15, 22		SV 33, 46, 66, 92		Recommended Seal	Elastomers
				304	316	CI/316	316		
Water	100	23/248		•	•	•	•	Q ₁ BEGG	E
Deionized, demineralized or distilled water	100	-13/230		•	•	•	•	Q ₁ BEGG	E
Water and oil emulsion	any	23/194		•	•	•	•	Q ₁ BVGG	V
Acetic acid (•)	80	14/158	.038	•	•	•	•	Q ₁ BEGG	E
Citric acid	5	14/158	.056	•	•	•	•	Q ₁ BEGG	E
Hydrochloric acid	2	23/77	.043		•		•	Q ₁ Q ₁ VGG	V
Phosphoric acid	10	23/86	.048		•		•	Q ₁ BEGG	E
Nitric acid (•)	50	23/86	.053	•	•	•	•	Q ₁ Q ₁ VGG	V
Sulphuric acid (•)	2	14/77	.066		•		•	Q ₁ BVGG	V
Tannic acid	20	32/122			•		•	Q ₁ BEGG	E
Tartaric acid	50	14/77	.063	•	•	•	•	Q ₁ Q ₁ VGG	V
Uric acid	80	14/176	.068	•	•	•	•	Q ₁ BEGG	E
Benzoic acid	70	32/158	.047	•	•	•	•	Q ₁ BVGG	V
Boric acid	Saturated	14/194	.052	•	•	•	•	Q ₁ Q ₁ VGG	V
Formic acid (•)	5	5/77	.044	•	•	•	•	Q ₁ BEGG	E
Ethyl alcohol (•)	100	23/104	.029	•	•	•	•	Q ₁ BEGG	E
Methyl alcohol (•)	100	23/104	.029	•	•	•	•	Q ₁ BEGG	E
Propyl alcohol (•)	100	23/176	.029	•	•	•	•	Q ₁ BEGG	E
Butyl alcohol	100	23/176	.030	•	•	•	•	Q ₁ BVGG	V
Denatured alcohol (•)	100	23/158	.030	•	•	•	•	Q ₁ BEGG	E
Ammonia in water (•)	25	-4/122	.038	•	•	•	•	Q ₁ BEGG	E
Chloroform		14/86	.053	•	•	•	•	Q ₁ BVGG	V
Caustic soda	25	32/158	.077	•	•	•	•	Q ₁ Q ₁ EGG	E
Water, detergents, mineral oils mixture		23/176		•	•	•	•	Q ₁ Q ₁ VGG	V
Cleaning products		23/212		•	•	•	•	Q ₁ Q ₁ VGG	V
Glycerine	100	68/194	.046	•	•	•	•	Q ₁ BEGG	E
Sodium Hypochlorite	1	14/77			•		•	Q ₁ Q ₁ VGG	V
Phosphates/polyphosphates		23/194			•		•	Q ₁ Q ₁ VGG	V
Sodium nitrate	Saturated	14/176	.081	•	•	•	•	Q ₁ BEGG	E
Cutting fluid	100	23/230	.033	•	•	•	•	Q ₁ BVGG	V
Peanut oil (•)	100	23/230	.034	•	•	•	•	Q ₁ BEGG	E
Colza oil (•)	100	23/230	.034	•	•	•	•	Q ₁ BEGG	E
Linseed oil (•)	100	23/230	.034	•	•	•	•	Q ₁ BEGG	E
Coconut oil (•)	100	-4/194	.033	•	•	•	•	Q ₁ BEGG	E
Soybean oil (•)	100	32/194		•	•	•	•	Q ₁ BEGG	E
Diathermic oil	100	23/230	.033	•	•	•	•	Q ₁ BVGG	V
Hydraulic oil	100	23/230		•	•	•	•	Q ₁ BVGG	V
Mineral oil	100	23/230	.034	•	•	•	•	Q ₁ BVGG	V
Sodium sulfate	15	14/104	.094	•	•	•	•	Q ₁ Q ₁ EGG	E
Aluminum sulfate	30	23/122	.097		•		•	Q ₁ Q ₁ EGG	E
Ammonium sulfate	10	14/140	.064		•		•	Q ₁ Q ₁ EGG	E
Iron sulfate	10	23/86	.076		•		•	Q ₁ BEGG	E
Copper sulfate	20	32/86	.082		•		•	Q ₁ Q ₁ VGG	V
Trichloroethylene		14/104	.053	•	•	•	•	Q ₁ BVGG	V
Perchloroethylene		14/86	.057	•	•	•	•	Q ₁ BVGG	V

Legend

Q₁ = Silicon carbide B = Impregnated carbon E = EPDM V = Viton G = AISI 316 (spring, metal components)

(•) A special version may be necessary for this fluid. For additional information, please contact our sales network.

Xylem |'zīləm|

- 1) The tissue in plants that brings water upward from the roots;
- 2) a leading global water technology company.

We're a global team unified in a common purpose: creating advanced technology solutions to the world's water challenges. Developing new technologies that will improve the way water is used, conserved, and re-used in the future is central to our work. Our products and services move, treat, analyze, monitor and return water to the environment, in public utility, industrial, residential and commercial building services settings. Xylem also provides a leading portfolio of smart metering, network technologies and advanced analytics solutions for water, electric and gas utilities. In more than 150 countries, we have strong, long-standing relationships with customers who know us for our powerful combination of leading product brands and applications expertise with a strong focus on developing comprehensive, sustainable solutions.

For more information on how Xylem can help you, go to www.xylem.com

Learn more about
e-SVX Smart Pumps:



Xylem Product Cybersecurity:

Xylem values your system security and the availability of your critical services. For more information on Xylem cybersecurity practices or to contact the cybersecurity team please visit xylem.com/security.



Xylem Inc.
Phone: (866) 673-0428
Fax: (888) 322-5877
www.xylem.com/goulds

Xylem and Hydrovar are registered trademarks of Xylem Inc. or one of its subsidiaries. Goulds is a registered trademark of ITT Manufacturing Enterprises LLC and is used under license. MODBUS is a registered trademark of Schneider Electric USA, Inc. All other trademarks or registered trademarks are property of their respective owners.

©2024 Xylem Inc. GWTe-SVXTB400004 R3 October 2024