

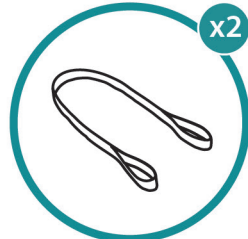

# e-SV hydrovar X Series

Electric pump with integrated variable speed drive

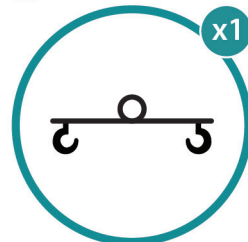
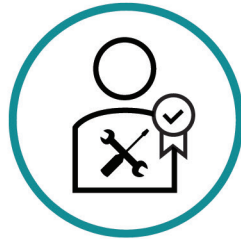

Torx



QR		Code	
QR	Code	QR	Code
01	01	02	02
03	03	04	04
05	05	06	06
07	07	08	08
09	09	10	10
11	11	12	12
13	13	14	14
15	15	16	16
17	17	18	18
19	19	20	20
21	21	22	22
23	23	24	24
25	25	26	26
27	27	28	28
29	29	30	30
31	31	32	32
33	33	34	34
35	35	36	36
37	37	38	38
39	39	40	40
41	41	42	42
43	43	44	44
45	45	46	46
47	47	48	48
49	49	50	50
51	51	52	52
53	53	54	54
55	55	56	56
57	57	58	58
59	59	60	60
61	61	62	62
63	63	64	64
65	65	66	66
67	67	68	68
69	69	70	70
71	71	72	72
73	73	74	74
75	75	76	76
77	77	78	78
79	79	80	80
81	81	82	82
83	83	84	84
85	85	86	86
87	87	88	88
89	89	90	90
91	91	92	92
93	93	94	94
95	95	96	96
97	97	98	98
99	99	00	00



% <50% @ 40°C (104°F)

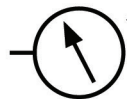

QR		Code	
QR	Code	QR	Code
01	01	02	02
03	03	04	04
05	05	06	06
07	07	08	08
09	09	10	10
11	11	12	12
13	13	14	14
15	15	16	16
17	17	18	18
19	19	20	20
21	21	22	22
23	23	24	24
25	25	26	26
27	27	28	28
29	29	30	30
31	31	32	32
33	33	34	34
35	35	36	36
37	37	38	38
39	39	40	40
41	41	42	42
43	43	44	44
45	45	46	46
47	47	48	48
49	49	50	50
51	51	52	52
53	53	54	54
55	55	56	56
57	57	58	58
59	59	60	60
61	61	62	62
63	63	64	64
65	65	66	66
67	67	68	68
69	69	70	70
71	71	72	72
73	73	74	74
75	75	76	76
77	77	78	78
79	79	80	80
81	81	82	82
83	83	84	84
85	85	86	86
87	87	88	88
89	89	90	90
91	91	92	92
93	93	94	94
95	95	96	96
97	97	98	98
99	99	00	00



i

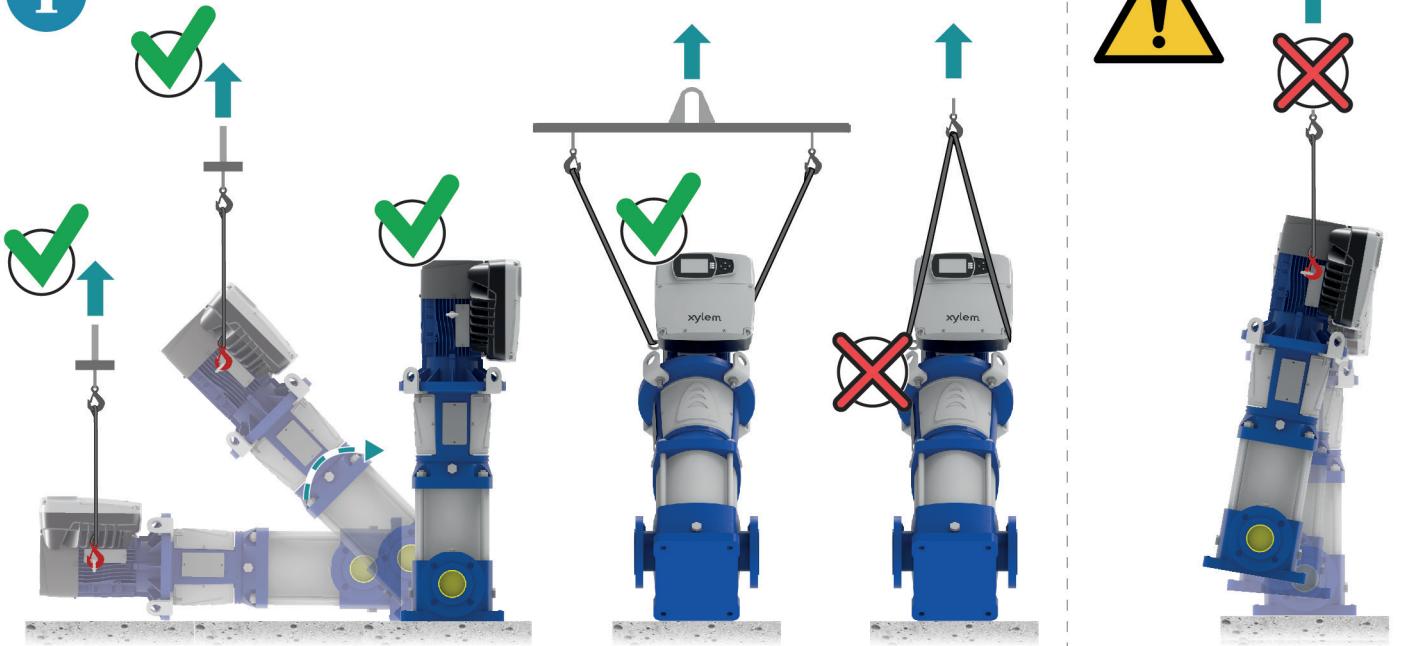

1

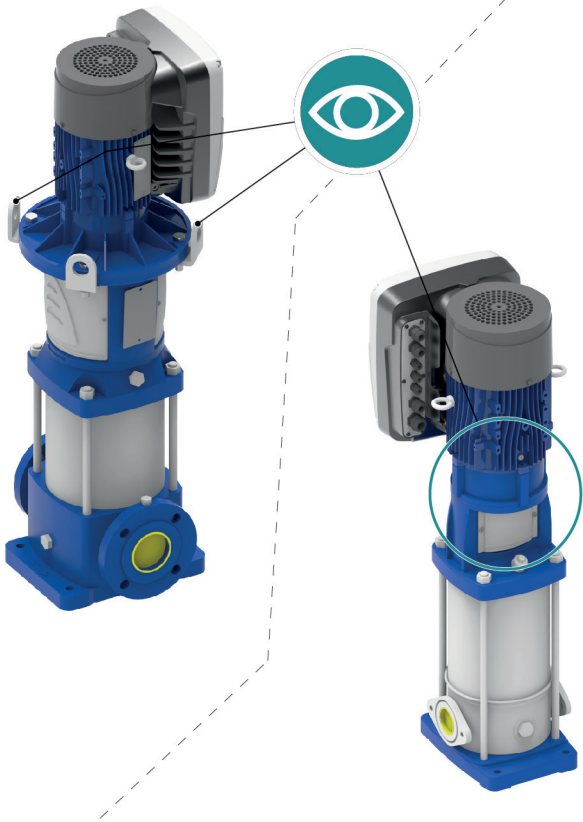

2

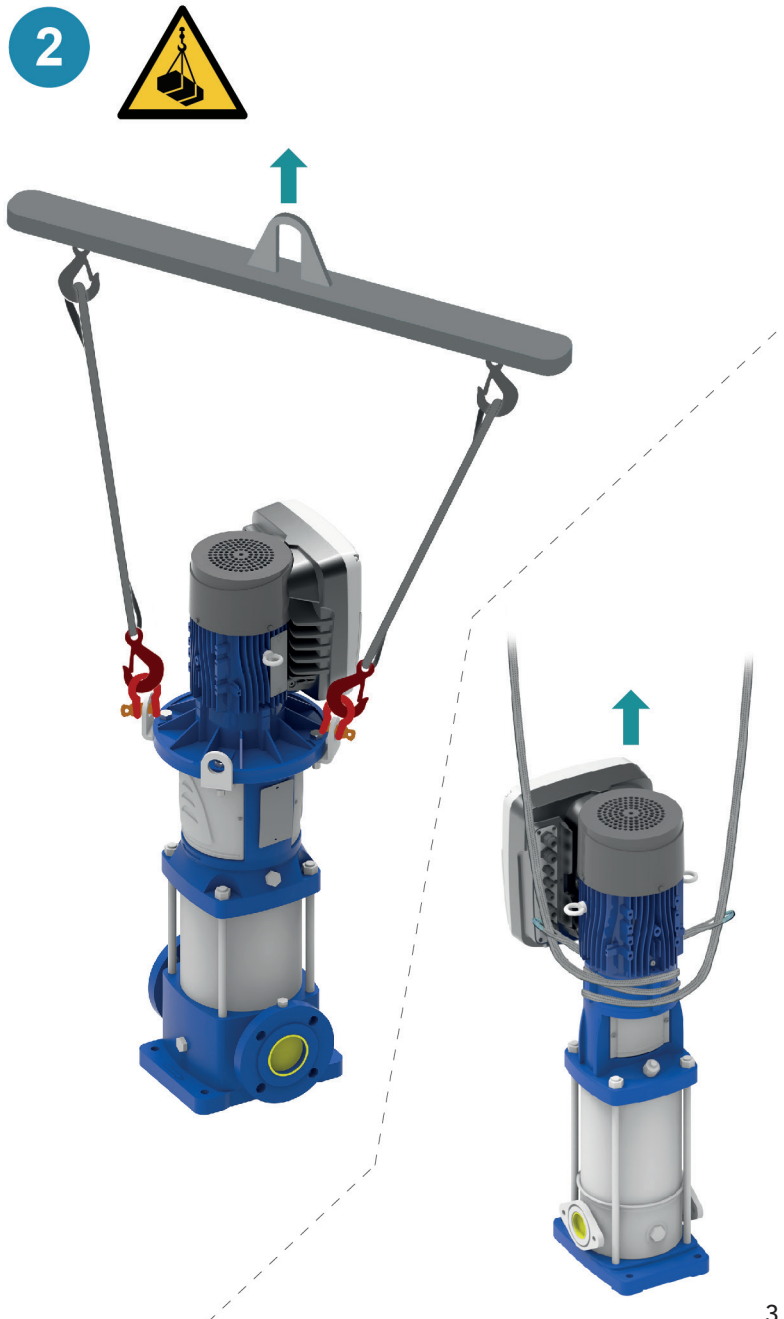

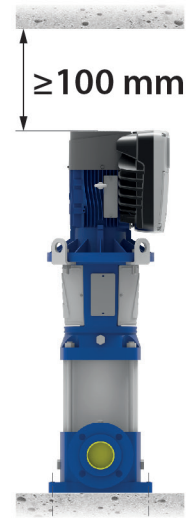

3

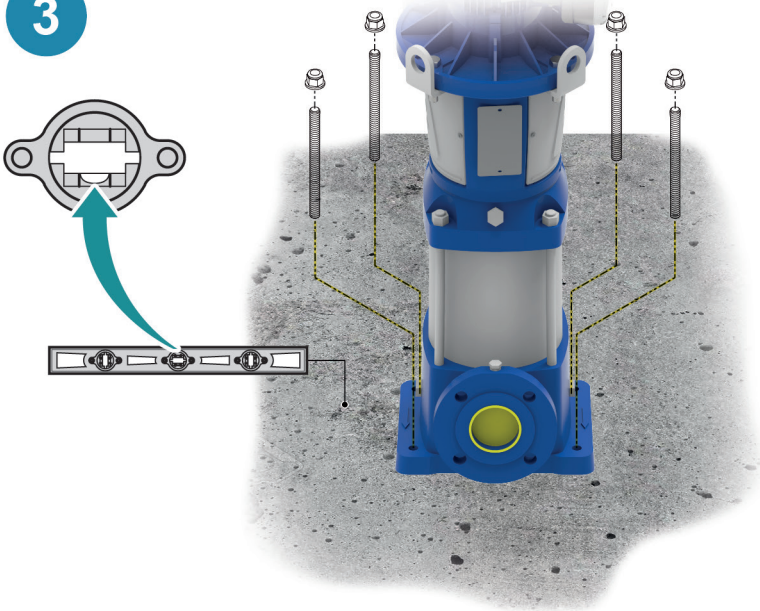

4



5

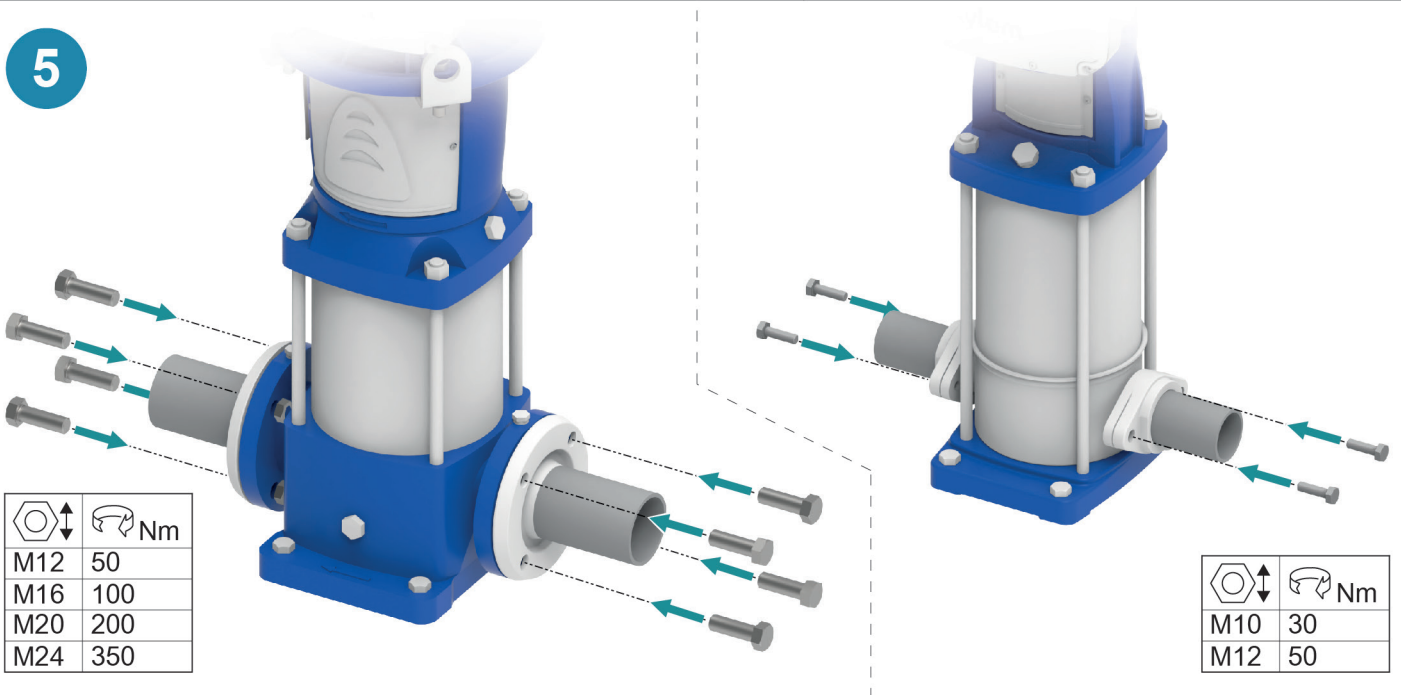

Hex Bolt	Torque (Nm)
M12	50
M16	100
M20	200
M24	350

Hex Bolt	Torque (Nm)
M10	30
M12	50

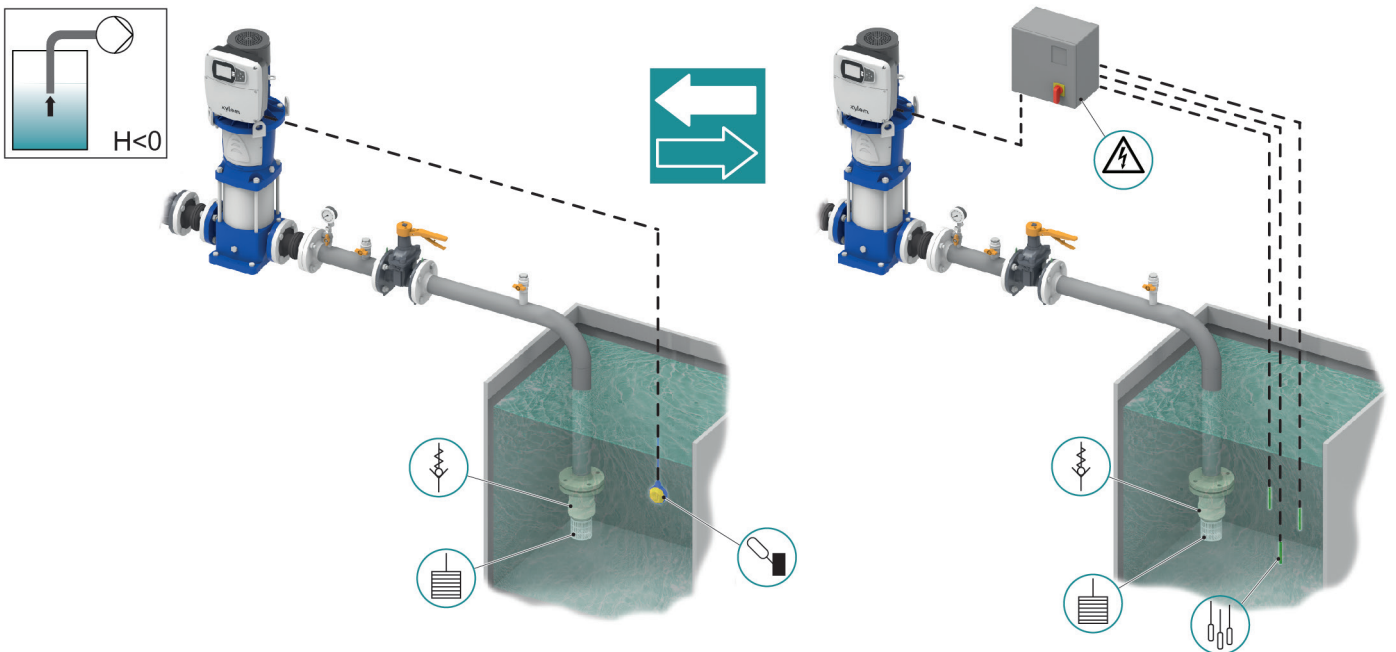
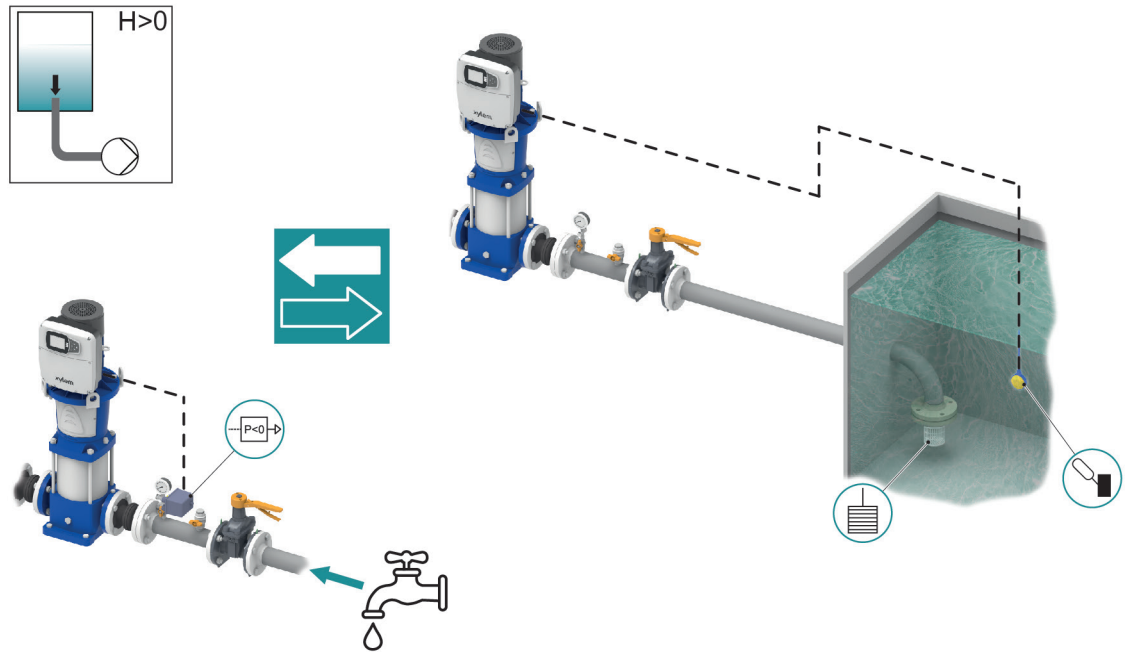
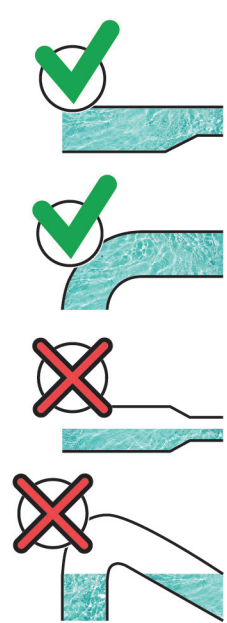
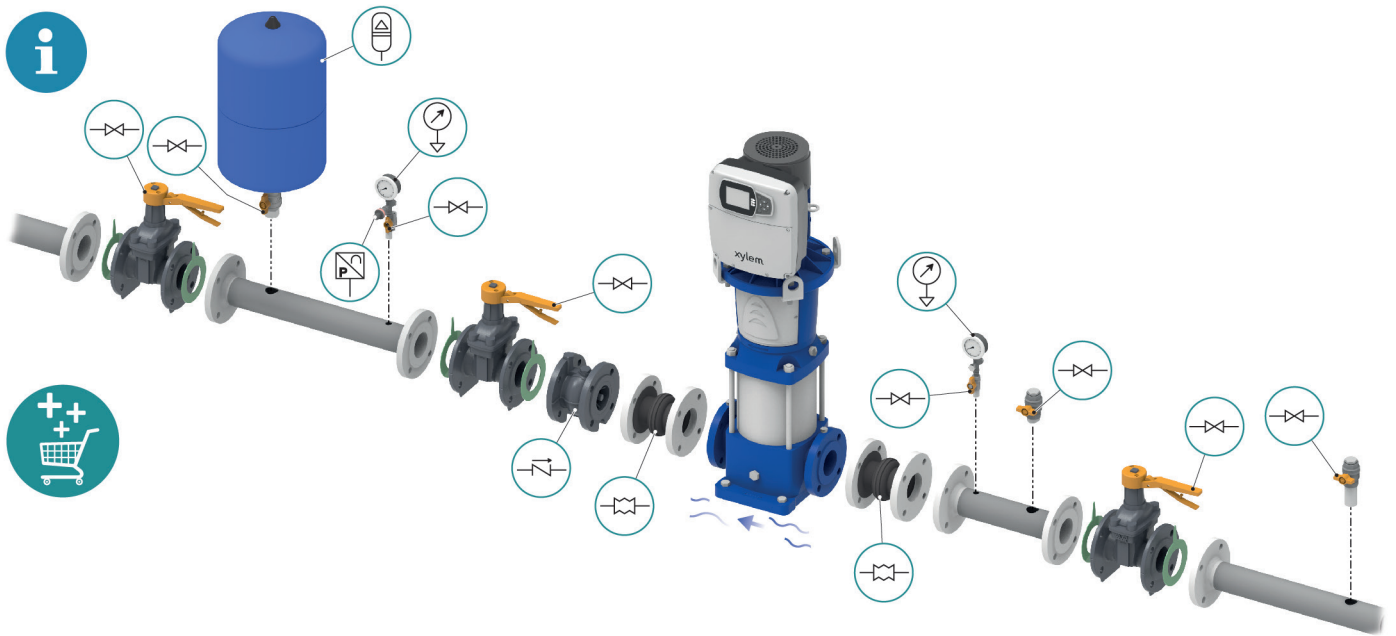

6



7

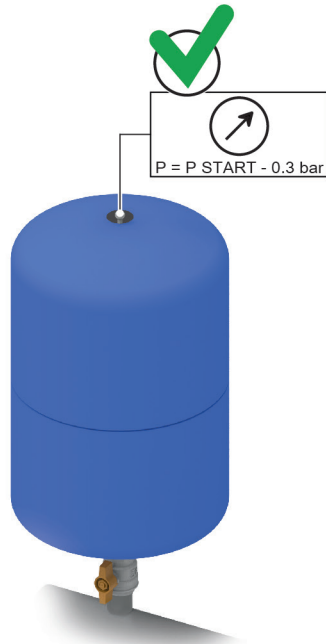

8



9

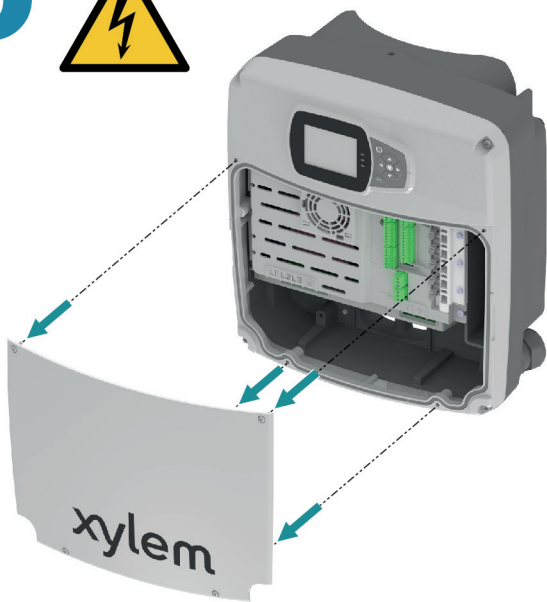

10

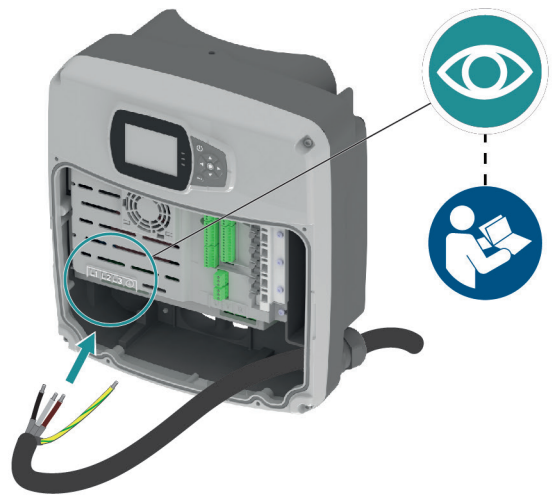

11

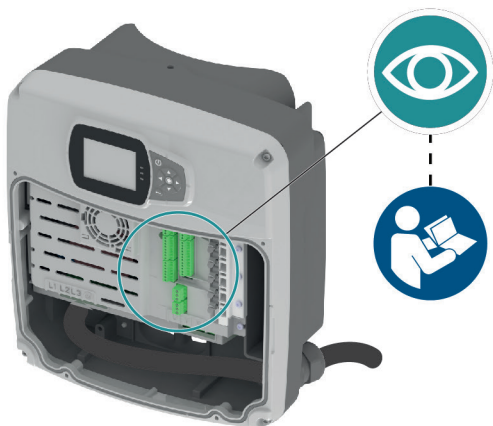

12



 3 Nm  
±15%

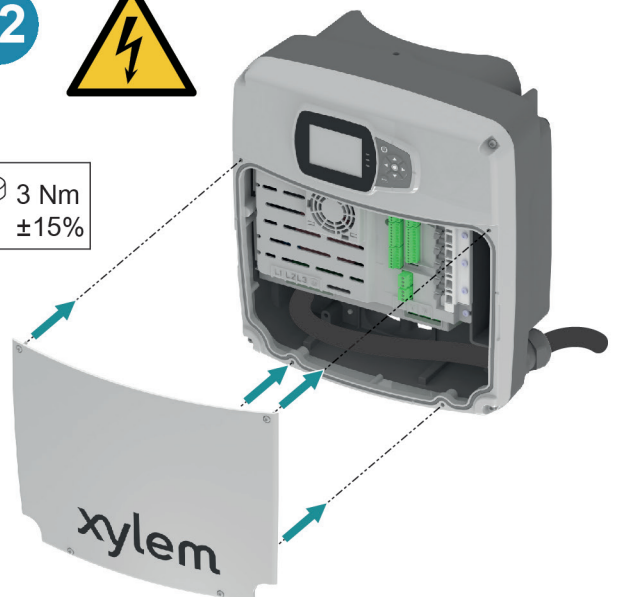

13



14

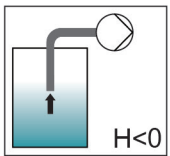
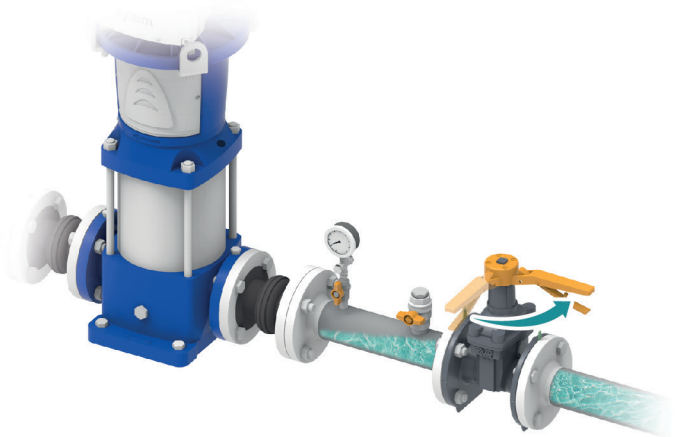
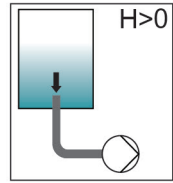

1  
ON

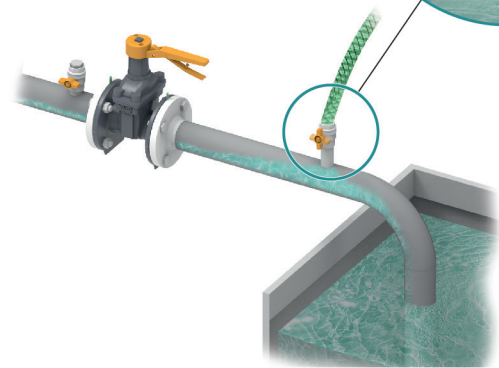
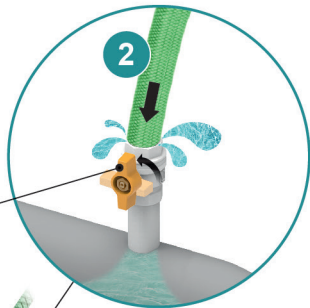

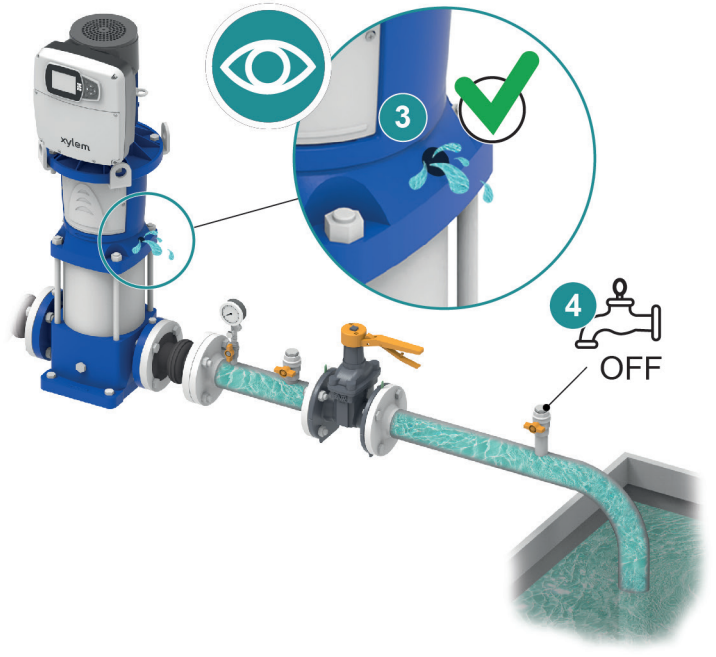

4  
OFF

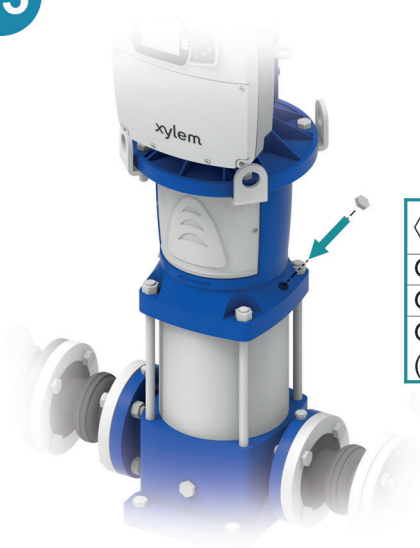

15



 $\updownarrow$	 Nm
G 3/8"	25
G 1/2"	40
G 1/2" (125SV)	30

16





SVX (e-SV hydrovar X+)



SVK (e-SV hydrovar X)



17 SVX



SVK

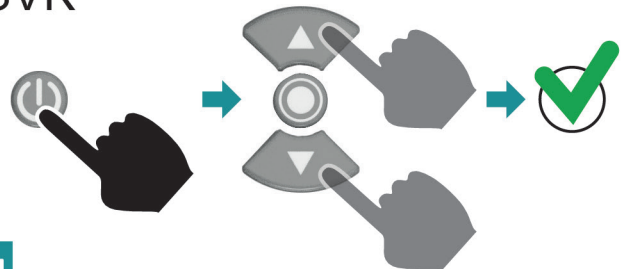

18

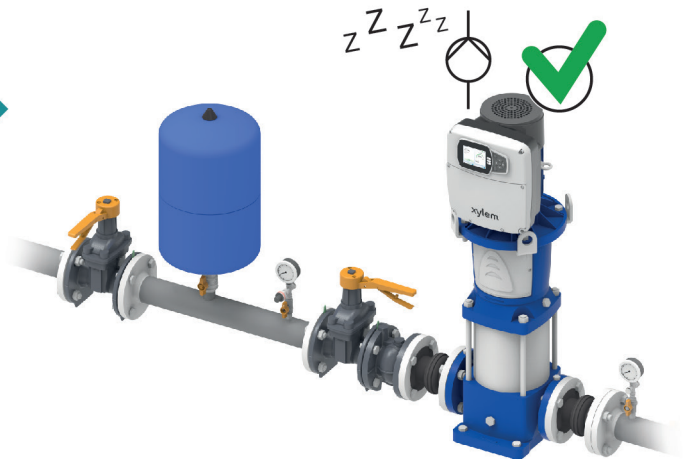
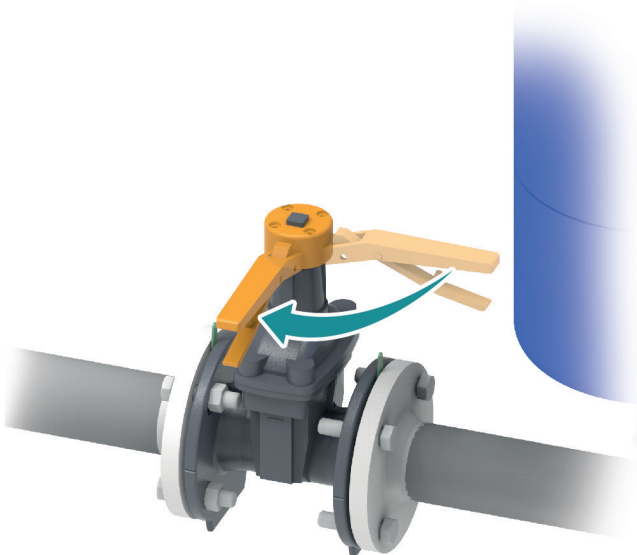



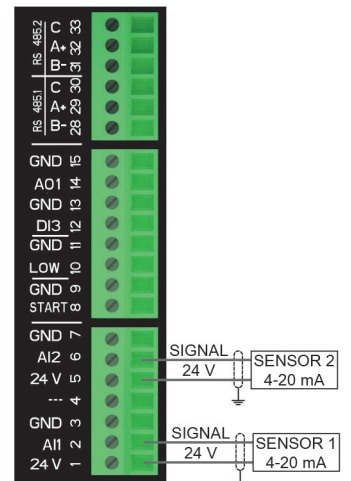
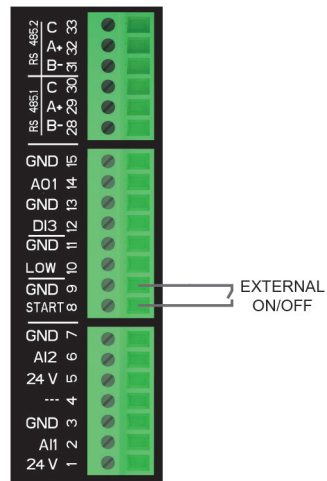
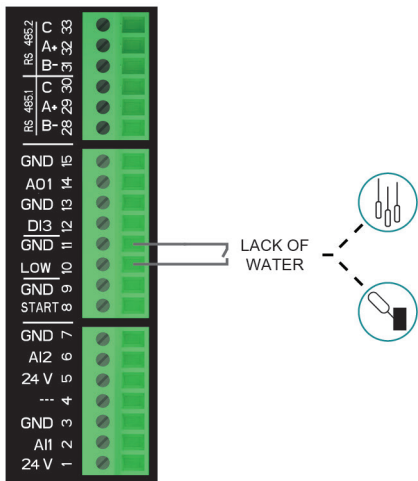
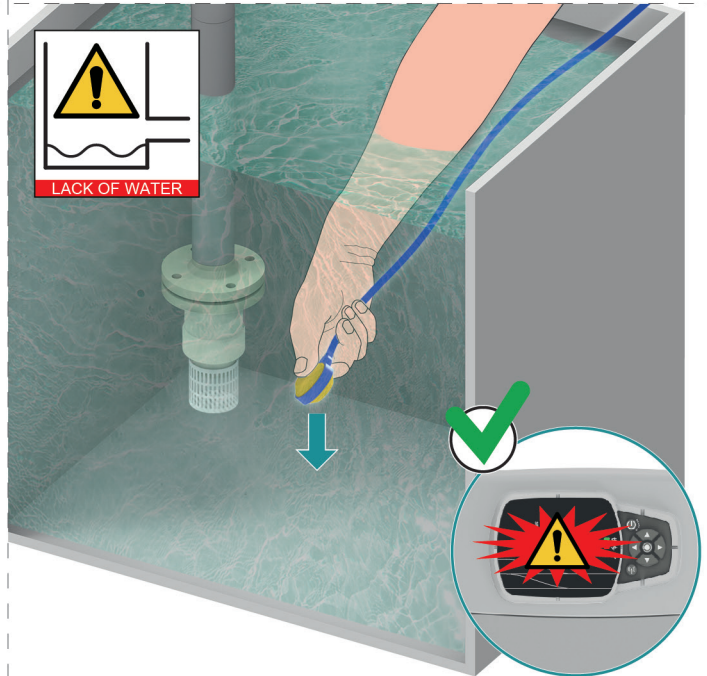
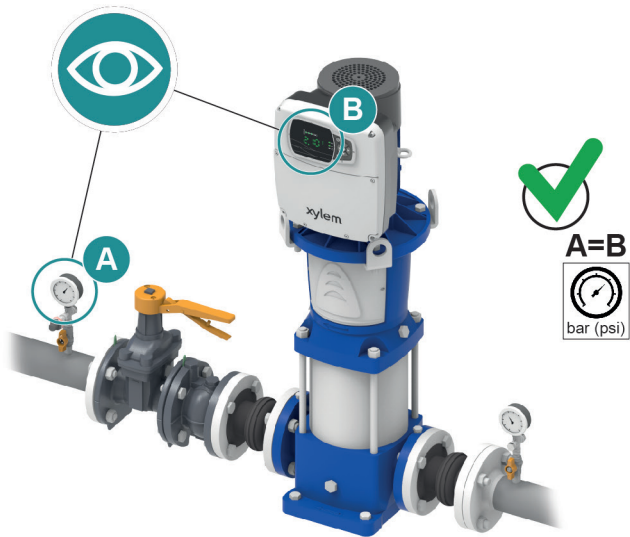
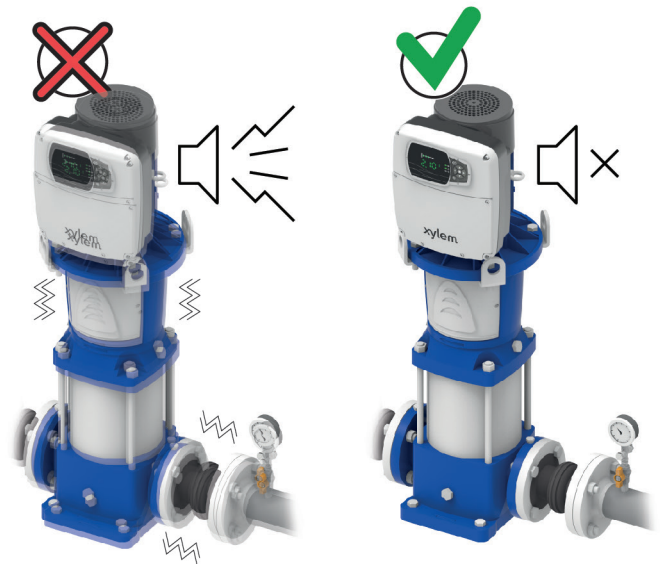
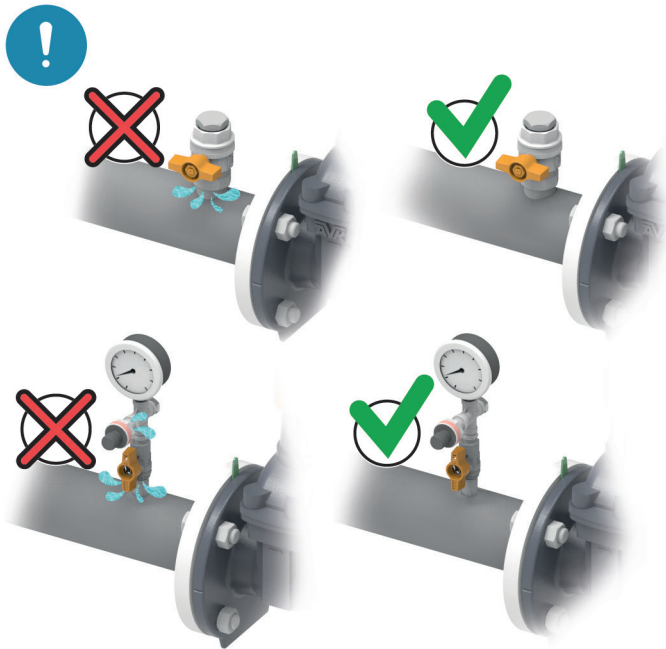

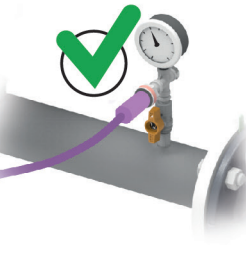
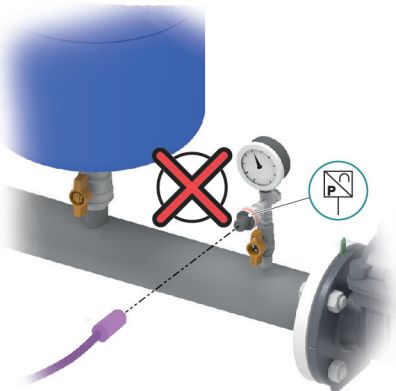
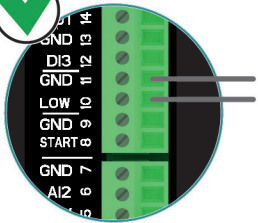
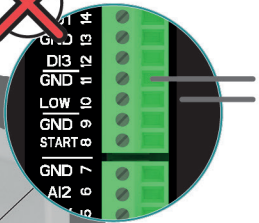
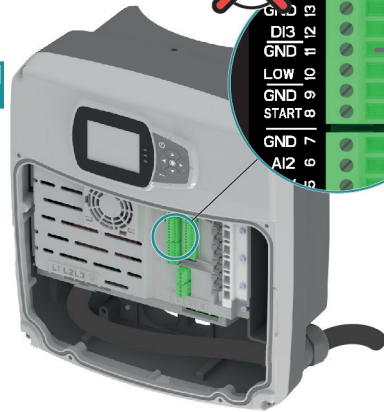
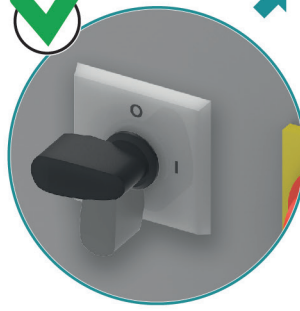
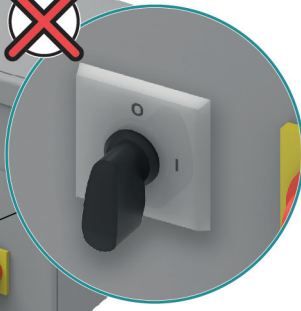
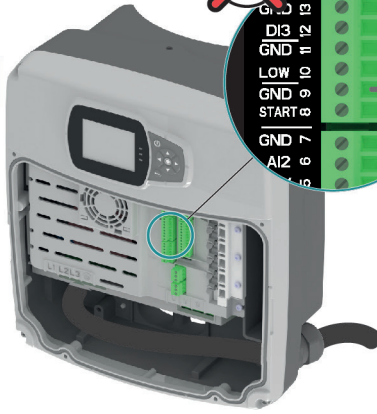
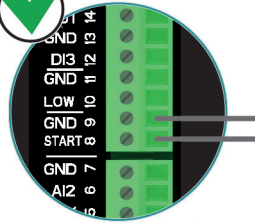
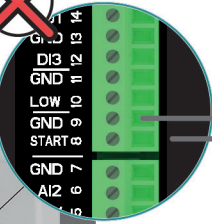

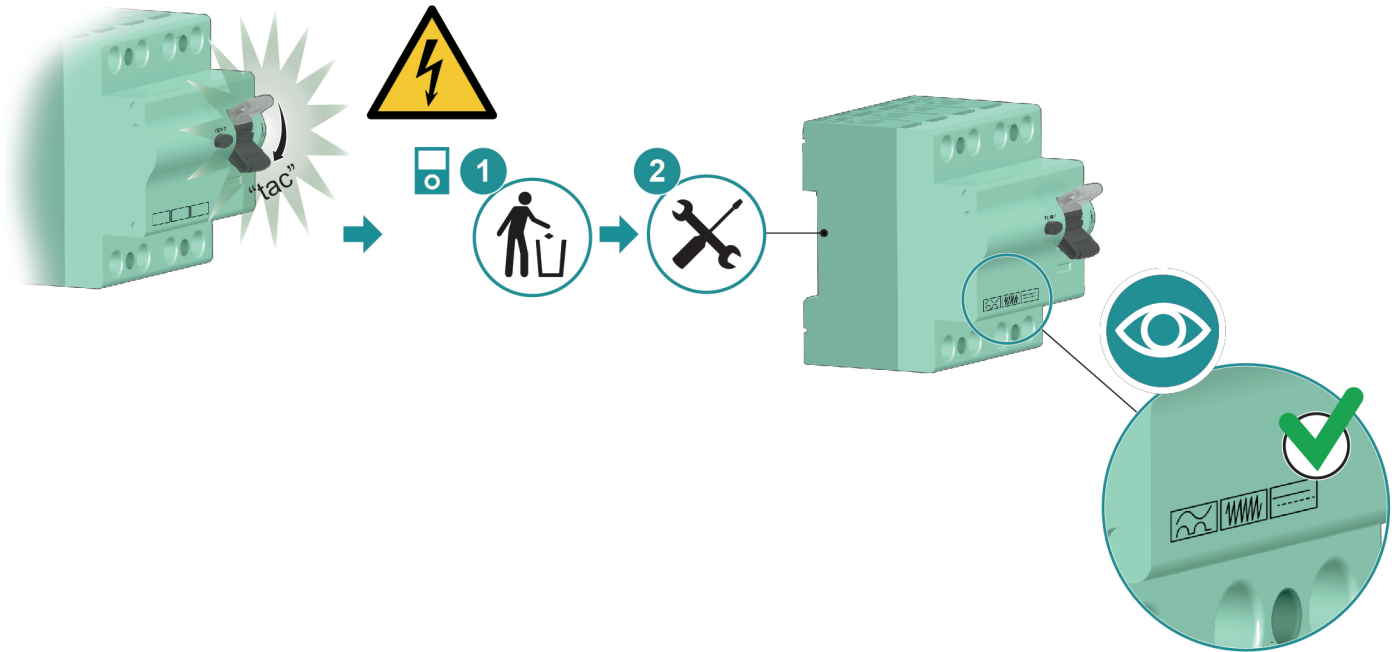
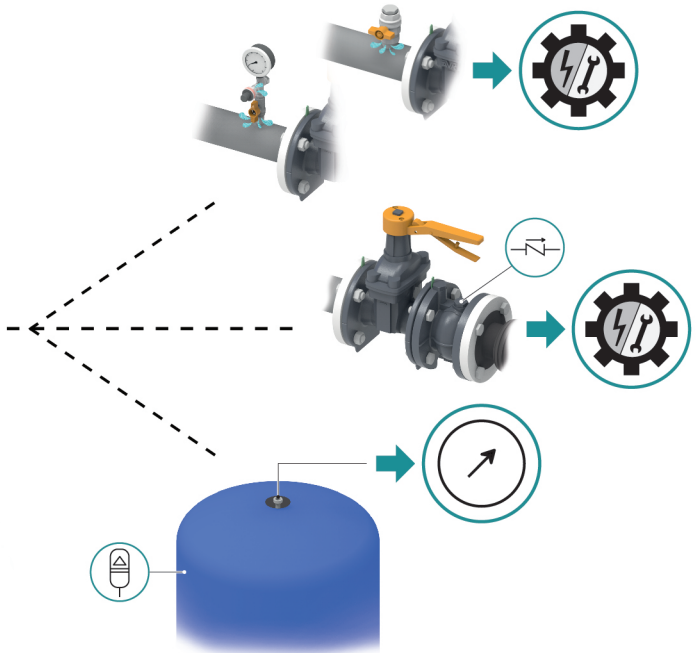

19





Xylem Service Italia S.r.l.  
Via Vittorio Lombardi 14  
36075 - Montecchio Maggiore (VI) - Italy

[xylem.com/lowara](https://xylem.com/lowara)  
Visit our Web site for the latest version of this document and more information  
© 2023 Xylem Inc  
Cod.001088104 rev.A ed.03/2023