



Clean Water Solutions and Services

TOTAL CONTROL THROUGHOUT THE CLEAN WATER CYCLE

xylem
Let's Solve Water

Water quality, quantity and availability - mastered

At Xylem, we believe that if you can change water, you can change everything. Every day, we focus on harnessing the expertise and commitment of our nearly 17,000 colleagues to help make water safer, more accessible and more affordable for people and communities around the world. Working together, we are united in our purpose of creating both economic and social value.

We understand your challenges in delivering the clean water the world relies on. And we're on hand with technology and expertise to help you deliver safe water, in the right quantity at the right time. Xylem is your partner for each step of the water cycle, from complete treatment solutions to elimination of water losses and total process control.

Every day, organizations and businesses around the world depend on our products and services to master water challenges and achieve better results with less hassle.

Our four principles for your sustainable success

Through decades of applications experience and innovation, Xylem has identified four keys to successful and sustainable clean water operations. We are committed to helping you master them.

1. Quality. Quality. Quality.

Your reputation depends on it. And so does ours. That's why we've developed a portfolio of the most advanced and effective solutions available for water treatment, analysis and process optimization. But the biggest advantages happen when you combine these with our expertise in facilities design.

2. Know your world

Knowledge is the secret ingredient behind the most successful and sustainable operations. We have the tools to ensure a total understanding of your ecosystem at all times. From precise measurement to analysis, monitoring, network management and prediction - we ensure the answers are always at your fingertips and that we're there for you to stay on top of it all.

3. Guard what you have

Since water is a valuable commodity, efficient management of this precious resource is a key factor for success. We have smart solutions to help you control all the key variables. From reducing non-revenue water to smart metering and billing, minimizing downtime and cutting energy consumption, we help you preserve your vital resources.

4. Keep it flowing

The water cycle is all about achieving a smooth, continuous flow without disturbances. Xylem can offer you the most efficient solutions to transport, remove, control and treat water. But we're also here to keep your operations and your business flowing, with expert advice and essential services that free up resources, remove barriers and enhance your offering to customers.



Technology that solves the water cycle

Advanced Water Treatment

A broad range of reliable treatment solutions including disinfection, oxidation, filtration, and biological treatment

Treatment Process Optimization

Water quality sensors combined with advanced algorithms to optimize the treatment processes

Treated Water Quality Monitoring

Comprehensive real-time water monitoring and reporting solutions to support regulatory compliance

Preventative and Predictive Maintenance

Connected equipment and maintenance solutions to reduce downtime and failures of critical equipment

Ecosystem M

Remote sensors to monitor and report on the health of water resources

Remote Operations Management

1-way and 2-way communications platforms to deliver real-time operations management

Water Network Management

In-situ and algorithmic solutions provide monitoring of network pressure, failures, and overall asset condition

Reduce Non-Revenue Water

In-situ and algorithmic solutions to identify, monitor, and address real and apparent water losses

Meter and Billing Management

Smart metering solutions to improve billing accuracy and enhance customer service

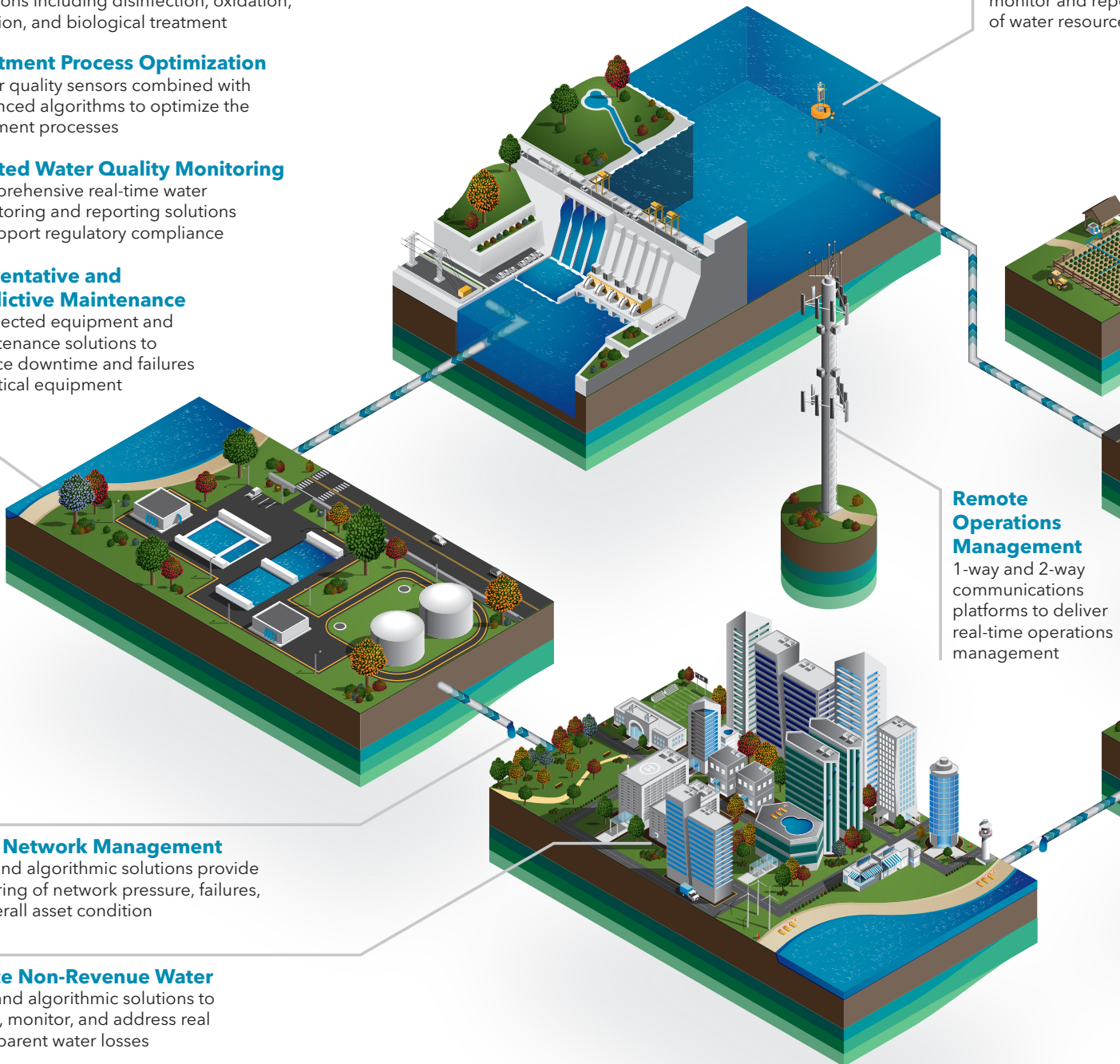

your challenges across

Monitoring
Solutions to
support on a variety
of parameters



Water catchment

Full control over water catchment, drilling and bypass with ACS-certified borehole pumps, single-stage pumps, submersible high-capacity pumps and our rental pump fleet.



Water analysis

A full range of water-quality analytic equipment for every need.

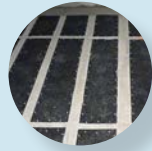

Clarification and filtration

Clarifiers and filters providing a complete set of solutions for drinking water purification.



UV disinfection

Fast and efficient inactivation of micro organisms for full disinfection.

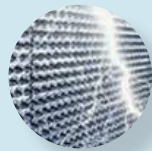

Ozone & advanced oxidation

Remove micropollutants, odour and colour to obtain high-quality drinking water.



Water distribution

An extensive range to secure reliable water supply, including variable and fixed-speed pumps, booster sets, constant pressure sets.



Monitoring and Control

Monitoring and control products help you remain in full control around the clock.



Leak Detection

Intelligent technologies and network management solutions detect and prevent leaks and potential system failures, for elimination of real water losses.



Water metering

High-performance water flow metering ensures delivery of exact water quantities and reduces apparent water losses.

Water cycle applications



	Large pumps	Hydro turbines	Borehole pumps	End suction centrifugal pumps	Multistage pumps	Booster sets	Dewatering and drainage pumps	Compact Submersible pumps
Page number	8	10	11	12	13	15	16	18
Deep well water pumping			•					
Surface water pumping	•			•	•		•	•
Power generation		•						
Water quality monitoring								
Water transfer	•		•	•	•	•	•	•
Basin drainage and bypass							•	
Source water clarification								
Water filtration								
Filtration pumping and backwashing				•	•			•
Filter backwash water recovery								
Membrane/RO system pressure boosting				•	•	•		
Pathogen disinfection								
Micropollutant oxidation and odour and colour removal								
Drinking water quality monitoring								
Water storage and distribution			•	•	•	•		
Network pressure boosting			•		•	•		
District heating water pumping				•	•			
Water flow metering								
Pipeline condition assessment								
Leak and burst detection								
Non-revenue water reporting								
Transient pressure monitoring								
General plant services	•		•	•	•	•	•	•
General Network services								

Flygt PL 7000 & LL, NL 3000 Pumps, Flygt AC Pumps WS and Lowara Vogel Series LS

Xylem’s range of Flygt and Lowara-branded large pumps is ideal for large-volume water transfer and applications where standardized products just won’t do. For the highest efficiency and capacity, look into our customized, high-capacity vertical column pumps. If you need to mount vertically or horizontally, with multiple-flange orientations, consider our large double suction / split case pumps. Our end-suction pumps offer an unmatched range of solids handling. And for the largest flow applications, our horizontal axial flow pumps can accommodate flows in excess of 115,000 m³/h.

Applications

- Surface water pumping
- Water transfer

Flygt PL 7000 Low Head and Flygt LL & NL 3000 Medium Head Pumps

- Xylem’s Flygt PL 7000 range transports medium to large volumes at low heads
- For medium heads, Xylem offers the Flygt LL 3000 range with single or multivane impellers and axial flow diffusers
- Xylem’s Flygt NL 3000 range is equipped with our proven N-impeller technology for maximum performance
- Submersible motors and slim propeller hydraulics provide a considerably smaller footprint than non-submersible pumps, enabling compact, low-cost pumping stations with no superstructure
- The pumps are always submerged when operating, enabling the motor to run cooler and more quietly than non-submersible propeller pumps



PL 7000

Series	Power (kW)		Max. head (m)	Max. flow (l/s)
	min	max		
PL 7000	6,0	575	2	7000
NL 3000	3,1	44	3	500
LL 3000	4,7	430	33	2400

Flygt A-C Series customized pumps

- Vertical Column, Split Case , and End Suction Pumps with virtually unlimited capacity
- Custom designs enable the pump to meet a wide variety of applications and operating ranges while maximizing the overall pumping efficiencies
- Hydraulic efficiencies up to 92%
- Heavy duty construction



End Suction Pump

Lowara Vogel Series LS

- Horizontal single-stage end-suction pump has a closed impeller and oil lubricated bearing frame
- Process design, back pull out for easy maintenance; allows disassembly of impeller and bearing frame without dismantling of the pump casing and motor
- Suction branch is axial, discharge radial is upwards (optional horizontal possible)
- Drive by electric motor and flexible coupling is arranged on common base plate
- Volute casing pumps compliant with ISO 5199

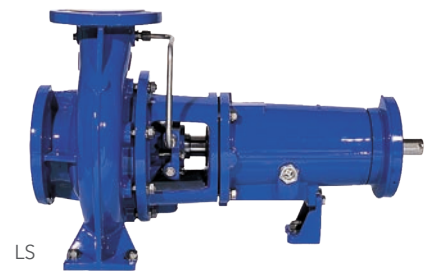

LS

Series	DN (mm)	Max. Head (m)	Max. Flow (l/s)
A-C Vertical Column Pumps	800-4000	180	25000+
A-C Split Case Pumps	600-1675	175	13900
A-C End Suction Pumps	100-5500	240+	115000
LS	18.5	710	170

Flygt Hydro Turbines

Xylem's range of Flygt-branded submersible turbines is the right match for power generation in almost any situation, in new plants or existing structures. As the largest submersible pump manufacturer in the world, our experience and history is placed into every submersible turbine we manufacture. With low initial investment cost and long lifetime, the return on investment in small scale hydro is short, which leads to good profitability. There's a simple reason why submersible turbines are chosen. Operating submerged, and out of the way, no expensive superstructure is required.

Applications

- Power generation

Easy to install and service

- Flygt submersible turbines can be installed in minutes, no assembly or shaft alignment needed. Flygt smart installation concepts allow easy removal for servicing.

Reliable and efficient

- Submersible turbines offer high operational efficiency and great reliability, no transmission shaft, couplings or intermediate bearings.

Invisible and quiet

- Submerged operation and below ground installation make Flygt turbines virtually silent and invisible

Accomodate wide variety of site conditions

- Usable in applications with heads up to 20 meters and flows up to 10 m³/s per unit

Auto-adjusts to varying flow

- The four largest available turbines offer an option with automatically adjustable runners (semi-Kaplan turbines) to handle varying flows and use in run-of-the-river conditions.

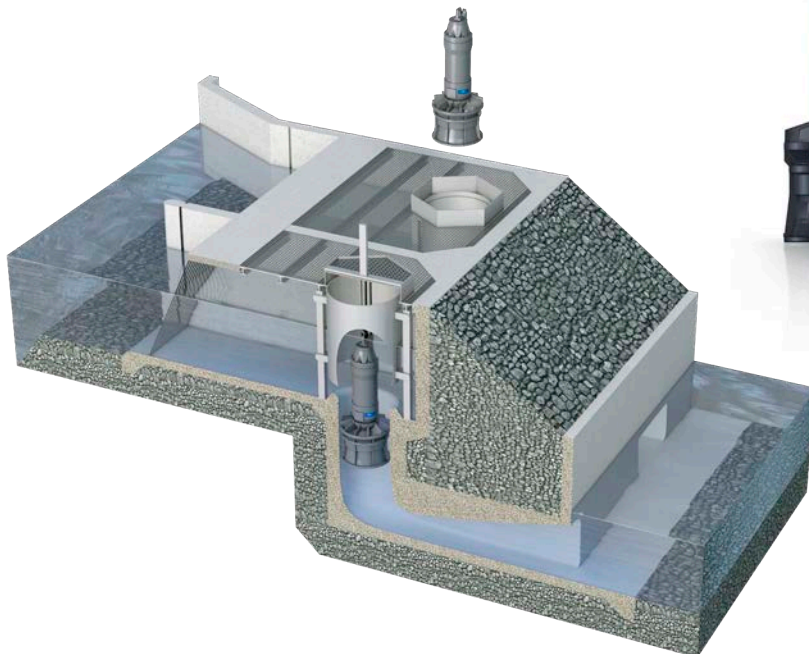

Hydro Turbines



Lowara e-GS, Z6, Z8, Z10, Z12, Vogel Series MPVs & PT

Xylem’s wide range of Lowara 4” to 12” submersible borehole pumps provides a cost-effective solution for a diversity of applications. Available in AISI 304, AISI 316 and duplex stainless steel, these pumps are ideal for situations requiring long service life. The hydraulics are designed for high sand handling capability. Common applications include water supply and irrigation, desalination and deep well dewatering. Durability and high efficiency are key characteristics of both the canned and rewindable versions.

Applications

- Deep well water pumping
- Surface water pumping
- Water transfer

Highest hydraulic efficiency on the market

- Energy and money saving

All parts made using investment casting

- High wear and corrosion resistance for long service life with high efficiency

Dynamic wear rings

- Hydrodynamic lubrication for minimization of wear and optimization of efficiency

Slide bearings in each stage

- Smooth operation and extended lifetime even under extreme operating conditions

Integrated non-return valve

- Easy, low-cost installation

Low maintenance needs

- High-grade materials and innovative design features (wear rings, slide bearings)

Duty point optimization

- Impellers can be trimmed to achieve maximum efficiency at specific duty point

Hydrovar option

- Optimized performance adjustment according to effective demand, ensuring system protection



Z8



Z6



PT

Submersible pump series	Drilling size (inches)	Max Power (kW)	Max head (m)	Max flow (m3/h)	Max Immersion depth (m)
E-GS	4"	7.5	310	22	300
Z series	6", 8", 10", 12"	350	700	520	350

Extended Shaft pump series	DN (mm)	Max Power (kW)	Max head	Max flow
			(m)	(m3/h)
MPVs/PT	40 - 250	355	500	1200

Lowara e-NSC



Combining robust design with high efficiency, Xylem’s range of Lowara e-NSC end-suction centrifugal pumps provides the perfect fit for any water supply application. Robust and floor mounted, with foot supported volutes in several designs, they are designed for high efficiency, with performance adapted for variable speed control. The pumps are engineered from stainless steel and cast iron to ensure corrosion resistance as abrasion-resistance. Common end-uses include residential and commercial buildings, public utilities, industry and aquaculture, irrigation, chillers and more.

Applications

- Surface water pumping
- Water transfer
- Filtration pumping and back-washing
- Membrane RO system pressure boosting
- Water storage and distribution
- Network pressure boosting
- Fire hydrant supply
- District heating water pumping
- General plant services

Compliant with ErP regulations

- MEI much greater than the recommended 0.4
- IE3 motors over the entire range

Performance boost

- Average +6pts efficiency increase over previous models
- Improved hydraulics, matching highest market standards in terms of Q&H

Wider coverage

- Large coverage from size 32 to size 300, covering a very large scope of need for cleanwater applications.

Greater applications coverage

- Covers cast iron, stainless steel, bronze, duplex
- Standard pressure rating (PN16) to handle various applications
- Comprehensive and improved mechanical seals offering
- Industrial options including advanced bearing bracket, cartridge seals, oil lubrication, etc.



NSCS

Reduced complexity

- Lighter and more compact, with more shared components

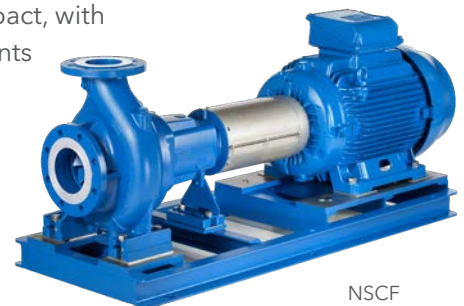

NSCF

Series	DN (mm)	Max Power (kW)	Max head (m)	Max flow (m ³ /h)
e-NSC	32-300	355	160	1800

Lowara e-MP and Lowara Vogel Series P

Xylem’s multistage Lowara-branded e-MP pumps in cast iron are designed to be installed and configured both vertically and horizontally. Robust and highly efficient, they ensure a long service life and low operational costs for many years. Xylem’s e-MP and P pumps are useful in numerous applications, including water transfer and network pressure boosting in water utilities, building services, agriculture and more. Today, they are also used for water supply in some of the highest buildings in the world as well as for filter pumping.

Applications

- Surface water pumping
- Water transfer
- Filtration pumping and back-washing
- Membrane/RO system pressure boosting
- Water storage and distribution
- Network pressure boosting
- Fire hydrant supply
- District heating water pumping
- General plant services

Simple integration

- Flexible mechanical configurations
- Suction impeller (low NPSH)

Safe operation

- Monitoring and control interfaces
- Large self-cleaning seal chamber

Energy savings

- High-efficiency hydraulics
- U-turn channels

Projectable service

- Optional sensor for bearing temperature and vibration
- Can be connected to any intelligent plant monitoring and diagnostic system

Reduced wear

- Plain bearing made of tungsten carbide and balancing system, reducing axial thrust on bearings and load on mechanical seals

Easy maintenance

- Bearing, mechanical seal and balancing drum bush can be serviced without removing the pump from the piping system
- Modular design reduces number of spare parts needed



e-MPA

Series	DN (mm)	Max Power (kW)	Max head (m)	Max flow (m ³ /h)
e-MP	50-150	1250	950	850
P/MP	300	1400	400	1800



Lowara e-SV

Xylem’s stainless steel Lowara-branded e-SV vertical multistage pumps offer a highly reliable, technologically advanced and multi-purpose solution for diverse clean water duties. Whether it’s pressure-boosting, water supply or another application, the e-SV range - featuring 11 different sizes and multiple designs - gets the job done. Additional applications include civil, agricultural, light industry, water treatment, heating and air conditioning.

Applications

- Surface water pumping
- Water transfer
- Filtration pumping and backwashing
- Membrane/RO system pressure boosting
- Water storage and distribution
- Network pressure boosting
- Fire hydrant supply
- District heating water pumping
- General plant services

Premium efficiency

- Save energy and reduce costs

Lower NPSH

- Quick, easy and low-cost installation

Easy-to-replace standard mechanical seal

- Only one service person needed, availability everywhere
- High availability
- Reduced maintenance and production stop costs

Standard vertical motor

- High availability
- Easy to customize
- Lower impact in production footprint

Balanced impeller

- No inlet pressure limitation
- Standard vertical motor
- Lower installation and maintenance costs

Dry run sensor

- Increased mean time between failure
- Lower maintenance and production stop costs

Series	DN (mm)	Max Power (kW)	Max head (m)	Max flow (m3/h)
e-SV	25 -125	55	330	160



e-SV



Lowara GHV Booster Sets

Xylem’s extensive range of Lowara-branded GHV series booster sets are packaged pumping stations assembled with two up to a maximum of eight vertical, multistage pumps from the e-SV series. The system solutions for water boosting and supply comprise variable and fixed-speed pumps and booster sets, as well as constant pressure sets. All pumps and sets are complete, ready to install and easy to commission. Additional uses include hospitals, hotels, public buildings, industry and more.

Applications

- Water transfer
- Membrane RO system pressure boosting
- Water storage and distribution
- Network pressure boosting
- General plant services

Energy efficiency

- Variable-speed energy saving
- IES2 power drive system
- Best-in-class hydraulic efficiency
- Two set points

High reliability

- IP55
- Bypass of faulty sensors
- Standard motors, balanced hydraulics
- Easy-to-replace standard mechanical seal

Certified for potable water use

- Full booster, not just parts
- WRAS, ACS, DM174 (standard units)
- No contamination of water

Wide range, compact design

- Vertical pump design
- Hydrovar motor mounted
- 2-4 pumps as standard, up to 8 on request
- 1-ph and 3-ph

Remote monitoring and control

- ModBus and BACnet as standard
- Additional I/Os also possible



GHV30 with 3 e-SV pumps

Series	Power (kW)	Max. flow (m ³ /h)	Max. head (m)
GHV	0,37 - 22	640	160

Other solutions on request

Godwin Self-Priming Pumps CD, HL, NC Dri-Prime®

Xylem’s line of Godwin-branded self-priming dewatering and drainage pumps offers automatic priming from dry to 8.5 meters - without requiring operator assistance. The pumps are engineered to deliver sustained high efficiency, resulting in lower energy and fuel costs and less unplanned downtime.

Renowned for their quality, reliability and long life, Xylem’s self-priming pumps are also used for water transfer in the mining, construction and industrial sectors.

Applications

- Surface water pumping
- Water transfer
- Basin drainage and bypass
- Fire hydrant supply
- General plant services



Dri-Prime® CD and HL

High efficiency

- Sustained hydraulic efficiency with unique self-cleaning, non-clog impeller
- Low total cost of ownership

Smart functionality

- Sound-attenuated enclosure for silent operation
- Smart remote controlling with Field Smart technology
- Highway trailer or skid mount with integral overnight running fuel tanks



NC150S

Reliability and durability

- Possibility of infinite dry operation
- Solids handling capability
- Dry automatic self-priming
- Robust design
- Stainless steel pump-end construction for high and low pH applications



Sound attenuated enclosure

Series	Max. head (m)	Max. flow (m ³ /h)
NC150S	62	370
CD	80	2,900
HL	200	1,300

Flygt Ready pumps

Xylem's Flygt Ready drainage pumps are durable, easy to carry, install and service, featuring compact motors and lightweight materials. These pumps are especially well suited for flood cleaning operations, water filled basements and emptying tanks.

Applications

- Surface water pumping
- Water transfer
- Basin drainage and bypass
- Fire hydrant supply
- General plant services

Convenient

- Compact, lightweight and easy to carry
- Easily stored in service vehicles for quick response
- Simple to install and service
- Easy access for cable and component changes
- Quick replacement of wear parts and seals

High performance

- Minimized back flush with built-in non-return valve
- Tough and durable with cast aluminum outer casing, stator housing and polyurethane hydraulic parts



Ready 4L is a low suction version, handling water levels down to 1-2 mm.

Series	Power (kW)	Rated current 1-Phase 230V (A)	DN (mm)	Max. immersion depth (m)	Weight (kg)
Ready pump	0,42 - 0,9	2,7 - 5,2	50	5	12 - 17

Flygt N3000 Series

The product range of submersible Flygt N-Pumps in its N3000 series is designed to dramatically reduce your total cost of ownership. The series features a superior hydraulic design which ensures efficient, reliable and trouble free pumping. N-Pumps sustain high pumping efficiency over time thanks to a unique open-type self-cleaning impeller. The result is an improved operational economy which effectively reduces the total life cost of your installation.

Applications include surface water pumping, general plant services, filtration and backwashing.

Applications

- Surface water pumping
- Water transfer
- Filtration pumping and back-washing
- General plant services

Low cost of ownership

- High efficient adaptive N hydraulics with superior clogging resistance reduces downtime
- Optional premium efficiency motors
- Integrated cooling system enables better motor utilization and minimizes energy waste
- Superior robust design ensures long lasting life time

Reliable and Flexible design

- High reliability for backwash water transfer
- Flexible design with wet and dry installations
- Modular design with different options for impeller material such as cast iron, hard iron and stainless steel



Series	Power (kW)	Max. Head (m)	Max Flow (l/s)
Flygt N3000	1.5 - 680	108	3000

Xylem Hydrovar®

Designed for effortless water monitoring and control, the Hydrovar pump controller from Xylem is a compact, modular and intelligent unit that matches performance to demand. The system consists of a variable speed drive (VSD), a control card, sensors, EMC filters and motor/system protection. Hydrovar is easily mounted directly onto any standard IEC pump motor, making it an excellent choice for retrofitting and upgrading of fixed speed systems. No external control panel is needed.

Applications

- Deep well water pumping
- Surface water pumping
- Water transfer
- Filtration pumping and backwashing (air or water)
- Membrane/RO system pressure boosting
- Water storage and distribution
- Network pressure boosting
- Fire hydrant supply
- District heating water pumping
- General plant services

Easy to commission

- Quick-start guide and logical navigation for easy set-up and operation
- Advanced programming features allow optimization for most duty conditions

Energy savings

- Potential energy savings of up to 70% on partial loads alone
- Typical investment payback period under two years

Full control

- Multi-pump capability from 1 to 8 pumps
- Constant pressure
- Constant flow
- Possibility of control along the system curve
- Can be controlled via a 4-20 mA or 0-10 V external signal
- Integrated communication via Wi-Fi card (optional)

Safe operation

- Fulfills EN 61000 standards
- Embedded THDi filter to reduce harmonic interference
- Stops pumps at zero flow
- Integrated soft start/stop: no water hammer and lower starting current
- Built-in pump protection



5th Generation Hydrovar



Series	Power (kW)	Power Supply
Hydrovar	1,5 - 22	single or three phase 50 or 60 Hz

Flygt MultiSmart[®], MJK MyConnect RTU

The Flygt, MJK and Lowara pumpstations and process controllers make water monitoring and control easier than ever. Easy to integrate and install, with clear user interfaces and built-in features, they offer advanced energy optimization, data collection and effortless communication. Designed primarily for pumping stations and small water treatment plants, these controllers measure and record overflow, control and monitor filters, raw water pumps and booster pumps for water supply. The controllers have built-in Wi-Fi and can easily be configured to connect with mobile devices.

Applications

- Deep well water pumping
- Surface water pumping
- Water transfer
- Filtration pumping and backwashing (air or water)
- Membrane/ROsystem pressure boosting
- Water storage and distribution
- Network pressure boosting
- Fire hydrant supply
- District heating water pumping

Flygt MultiSmart[®]

- Capable of handling up to six pumps
- Preconfigured functions to maximize efficiency, save time and reduce costs by preventing clogging and nuisance call-outs
- Intuitive, customizable interface



MultiSmart[®]

MJK MyConnect RTU

- Combined pump controller and remote telemetric unit
- Advanced energy optimization, data collection and communication features make water management easy
- Controls pumps, measures and records overflow, controls and monitors raw/ground water pumps, booster pumps, water treatment plants, filters and much more
- Built-in Wi-Fi card
- Configurable via a PC program, Connect Link, or controlled directly from a smartphone using the MJK Connect app.



MyConnect

Xylem SCADA

Flygt SCADA is a plug-and-play complete software solution based on the well-proven VTScada™* platform, with a Xylem-developed interface for water monitoring and control applications. Smart and intuitive, this future-proof software puts you in control in just hours.

Applications

- Deep well water pumping
- Surface water pumping
- Water quality monitoring
- Water transfer
- Basin drainage and bypass
- Source water clarification
- Water filtration
- Filtration pumping and backwashing (air or water)
- Filter backwash water recovery
- Membrane/RO system pressure boosting
- Pathogen disinfection
- Micropollutant oxidation and odour and colour removal
- Drinking water quality monitoring
- Water storage and distribution
- Network pressure boosting
- Fire hydrant supply
- District heating water pumping
- General plant services

Easy to install and use

- Intuitive, user-friendly interfaces
- Maps, trend reports, operator notes and alarm management tools are bundled into one simple install
- Managed cloud-based solution available for even easier installation and asset management: no installation, no maintenance, no updating of software or firewalls
- Hardware independent, offering open connectivity support for all brands of programmable logic controllers, remote telemetry units and any direct fieldbus instrumentation systems
- Designed to work seamlessly with Xylem's portfolio of products and brands

Proven and reliable

- Combines VTScada's 30-year track record, including thousands of installations, with Xylem's long experience in water management
- Performance is assured through features such as version control, multiple server redundancy and automated testing to ensure fewer bugs

Adapted for water applications

- Preconfigured with all relevant templates, daily routines and other specifications

Flexible and mobile

- On-the-go access from any Internet-enabled device
- Safely monitor and control your process from anywhere



*VTScada is a registered trademark of Trihedral Engineering, Ltd., Canada. SCADA

Leopold Filterworx[®], Leopold Underdrains & I.M.S[®] 200 Media Retainers, Leopold Clari-DAF[™]

Leopold water clarification and filtration solutions from Xylem add up to more than the sum of their parts. Designed to work seamlessly together, every filter, underdrain or air flotation system can be easily integrated to achieve superior results. Based on years of knowledge in this area, we are happy to assist you in designing and developing a cost-effective, energy-efficient, high-performance system to meet your precise requirements.

Applications

- Potable Water Filtration
- Source Water Clarification
- Filter Backwash Water Recovery

Leopold Filterworx[®]

- Includes media, backwash troughs, instrumentation and controls
- At the heart of the system are Leopold Type XA[™], Type S[®], or Type SL[®] filter underdrains in combination with I.M.S[®] 200 media support system

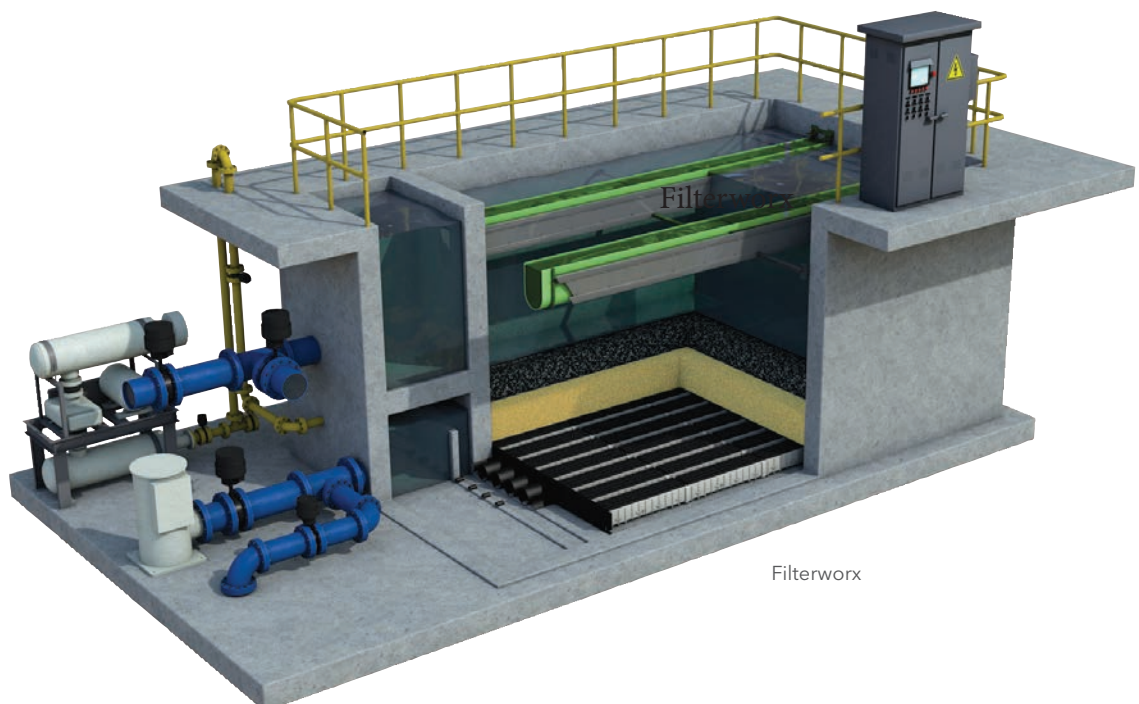

Filterworx

Leopold Underdrains & I.M.S.[®] 200 Media Retainers

- Underdrains collect filtered water during the filter run and distribute air and water during the backwash cycle
- Superior air and water distribution for effective backwash with less than +/-5% maldistribution and no dead zones, so media is 100% utilized
- Cleaner filters mean longer filter runs and higher water efficiency; more product water, less waste
- Faster installation with fewer parts than nozzle systems and no false floor, meaning greatly reduced civil costs and/or more room for media
- Design flexibility with different heights to allow for different combinations of lateral lengths and vertical filter heights, as well as different flume configurations
- I.M.S 200 media retainer is an integral media support engineered to allow for more available media expansion for improved backwashing and air and water distribution, eliminating dead spaces, and providing longer filter runs for cleaner media. Replaces up to 36 cm of gravel media support allowing for the same media depth in less vertical space



IMS 200 MediaRetainer on Leopold XA, S, and SL type bottom filter

Leopold Clari-DAF[™]

- Dissolved Air Flotation system providing potable water clarification prior to gravity media and membrane filters
- Dramatically enhances filtration performance for impounded water supplies
- Produces millions of micron-sized bubbles to efficiently remove contaminants (algae, organics & metals) via flotation that traditional sedimentation-based systems are ineffective in addressing

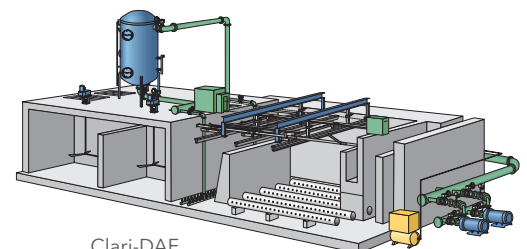

Clari-DAF

WEDECO

Spektron, K, Quadron and BX series

Xylem's Wedeco energy-efficient UV disinfection solutions for drinking water include well-proven technologies based on hundreds of thousands of successful installations worldwide. The technologies have been validated for disinfecting a wide variety of pathogens, including parasites (e.g. cryptosporidium and clostridium), bacteria (e.g. E. coli, salmonella typhi, vibrio cholerae, pseudomonas aeruginosa) and viruses (e.g. poliovirus, norovirus and rotavirus). As a purely physical disinfection solution and 100% chemical free, UV does not carry the risk of forming harmful by-products. UV disinfection eliminates the risks associated with on-site storage and handling of hazardous chemicals, keeping your treatment plant and the surrounding community protected from accidental leaks.

Applications

- Pathogen disinfection

WEDECO Spektron Series

- Wide array of applications, from domestic water supply to large municipal water plants with a capacity of more than 6000 m³/h per unit
- Certified and validated disinfection performance according to Austrian ÖNORM, German DVGW directives and US EPA UVDGM
- Easy fit to local conditions: compact design with patented OptiCone® flow diverter ensures excellent flow conditions in any installation
- Extra low energy consumption with more than 20% saving when upgraded with Ecoray® UV lamps and OptiDose UV dose controller
- Excellent performance monitoring by latest UV sensor technology and sophisticated control system (ÖNORM-verified UV intensity sensor)
- Easy installation with multiple flange and mounting options regardless of inlet piping conditions
- Fully automatic wiping system and Optidose UV dose pacing (optional)



WEDECO K Series

- Combines inline installation with energy-efficient high intensity, low pressure UV lamps. High capacity; can disinfect up to 11000 m³/h of drinking water per hour/system.
- Additional lamp rows can be added if water demand increases.
- Ecoray® UV lamps combine very low energy consumption with outstanding temperature stability
- Long lamp life
- Very low headloss (inline installation)
- ÖNORM-certified UV intensity sensor

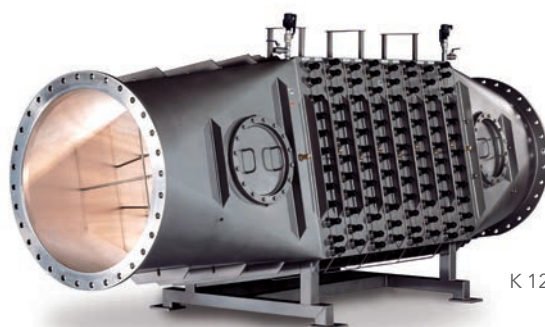

WEDECO Quadron Series

- Compact form due to powerful medium-pressure UV lamps and unique hydraulic design; flexible installation for all site conditions, including automatic, chemical-free wiping system.
- Disinfection performance according to stringent German DVGW certification and validated according US EPA UVDGM.
- Designed for maximum effectiveness against waterborne pathogens, with special attention to the effects of low-UV wavelengths (< 240 nm)
- Easy fit to local conditions; compact in-line design with patented OptiCone™ flow diverter ensures excellent flow conditions in any installation
- UV Intensity UV dose pacing keeps the system operating at optimum efficiency for reduced energy consumption (ÖNORM-certified UV sensor).



WEDECO BX Series

- High disinfection performance with low energy consumption
- Fully-automatic wiping system and Optidose UV dose (optional)
- Compact design
- Continuous monitoring thanks to calibrated UV sensor with high selectivity (ÖNORM-verified UV intensity sensor)
- Easy operation and maintenance
- Extra low energy consumption with more than 20% saving when upgraded with Ecoray® UV lamps and OptiDose UV dose controller

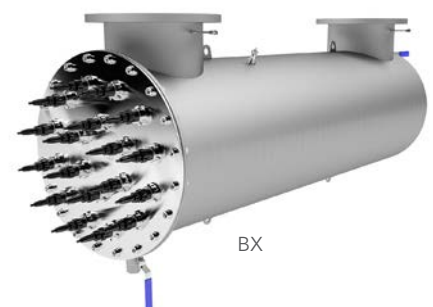

Wedeco ozonation systems, Sanitaire fine bubble ozone dissolution system

Xylem's Wedeco-branded ozone oxidation systems offer a unique, cost-effective environmentally friendly alternative to oxidation with chlorine, absorption (activated carbon), or other separation processes (membrane technology). By decomposing to oxygen when it reacts, this powerful oxidant destroys pollutants, coloured substances, odours and microorganisms - without creating harmful chlorinated by-products or significant residues. Xylem's Wedeco ozone generators combine maximum flexibility and reliability for small to large ozone capacities. The ozone generator system and control unit can be combined and supplemented with numerous option sets that allow project-specific customization for almost all applications.

Applications

- Pathogen disinfection
- Micropollutant oxidation and odor and color removal

Wedeco SMOevo^{PLUS} and PDOevo^{PLUS} series

- SMOevoPLUS series: Ozone production of 400 g/h to 23800 g/h
- PDOevoPLUS series: Ozone production of 6100 g/h to 277000 g/h
- Maximum flexibility and reliable operating characteristics for small to large ozone capacities.
- Option sets allow for various application requirements
- Low cooling water consumption
- Plug-and-play system; customized, mounted and instrumented
- Robust design for tough conditions
- Easy installation and operation
- Virtually maintenance-free electrode technology
- 10-year replacement warranty on Effizon evo 2G electrodes
- CE and UL certified

SMOevo^{PLUS}



Wedeco GSO 18 Series

- Ozone generators designed to produce ozone effectively at high concentrations, up to 13 weight % ozone.
- Highest ozone concentration yields at lowest energy demand.
- Ozone production of 3 g/h to 400 g/h
- Compact and modular design
- Low installation and maintenance requirements
- Low investment and operating costs
- Engineered for permanent operation

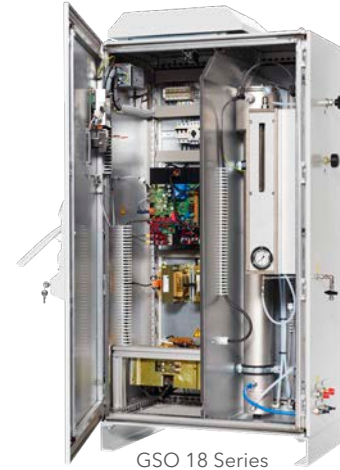

GSO 18 Series

Sanitaire fine bubble ozone dissolution system

- Ceramic diffuser design and controlled permeability promotes dependable uniform ozone distribution and bubble release; recognized as an efficient technology for ozone dissolution at water treatment plants
- Diffuser holders and piping fabricated for Type 316L stainless steel
- Diffuser designed with built-in flow balancing orifice
- Dome diffuser are available in 178-mm diameter
- 63.6-mm ceramic tube diffusers available in variable lengths



Ozone dissolution system

Series	Description	Ozone production
GSO 18 series	Small "ready to install" ozone generators	3 g/h to 400 g/h per unit
SMOevo ^{PLUS}	Compact Skid system for average ozone production capacity	400 g/h to 23800 g/h per unit
PDOevo ^{PLUS}	Production of high volumes of ozone	6100 g/h to 277000 g/h per unit

Wedeco MiPRO™ advanced oxidation process

Advanced Oxidation Processes (AOPs) combine either ozone + hydrogen peroxide or strong UV irradiation + hydrogen peroxide/ chlorine to make water safe for drinking and even suitable for very sensitive industrial processes.

AOPs provide strong benefits in your drinking water treatment by removing chemicals and disinfection at the same time.

A big concern often seen in drinking water treatment is Harmful Algal Blooms (HABs) caused by blue algae, an unwanted bacteria found in lakes and reservoirs as green "carpet" on the water surface. Harmful Algal Blooms are accompanied by bad taste and odour of drinking water and even human health problems caused by bacteria toxins. HABs are appearing more frequent due to warmer seasons caused by climate change and a high appearance of nutrients. Wedeco, a Xylem brand, uses AOPs in their MiPRO portfolio to get rid of those unwanted issues in treated surface water and so strongly contributes to healthy and tasty drinking water.

But not only natural contaminants affect our drinking water negatively. Also recalcitrant and toxic chemicals like 1,4-dioxane, NDMA or MTBE from industrial activities reach the groundwater. AOPs are a very efficient technology for removing those compounds where other treatment solutions fail. The AOP treated groundwater is often pumped back into the ground for groundwater remediation or as an barrier against sea water intrusion into the aquifer near the coast. Direct distribution of the treated groundwater to the customers or into an open reservoir is another often applied strategy by water suppliers. With its MiPRO products, Wedeco supports you whenever you are facing recalcitrant chemical pollutants and profit from an additional disinfection.



WTW portable analytic equipment

Xylem's WTW range of portable analytic equipment for raw water is arguably the most complete series of measuring instrumentation and accessories on the market. You'll find a product for virtually any need. The range includes pocket meters, photometers and benchtop meters.

Applications

- Water quality monitoring

Portable colorimeter pHotoFlex® Series

- Portable pocket photometers offering unique combinations of true multi-parameters
- Photometry, pH and turbidity measurement (DIN/ISO) for environmental monitoring and extensive water and routine analytics in (mobile) service labs
- Intuitive and easy operation
- Captive adapter for two cuvette sizes
- Robust and waterproof



pHotoFlex® Series

Portable meter MultiLine® Multi 3630 IDS

- Measure pH, ORP, dissolved oxygen, conductivity and/or turbidity
- Display and document three parameters simultaneously
- GLP supporting sensor and meter information
- Wireless ready
- Digital secure signal transfer
- Three galvanically isolated sensor inputs



MultiLine Multi 3630 IDS

Portable meter ProfiLine Multi 3320

- Universal multi-parameter pocket meter with two inputs for pH, mV, ISE, conductivity and dissolved oxygen determination in environmental applications
- Comprehensive measuring functions for pH, ORP, ISE, conductivity and dissolved oxygen
- Built-in memory and data logger to capture measuring series
- Robust and waterproof
- Backlit graphic display for parallel output of measured values



ProfiLine Multi 3320

WTW online analytic equipment

For analyzing and monitoring drinking water, Xylem's WTW brand offers one of the most complete range of analytic equipment in the world. The scope of technology includes pH/ORP, oxygen, conductivity and self-cleaning turbidity measurement as well as a comprehensive range of accessories. Based on their proven reliability, operational safety and versatility, WTW measurement systems and analyzers have become a global industry standard. In particular, the IQ SENSOR NET and MultiLine® system, which include state-of-the-art digital sensors, set the pace for online measuring technology.

Applications

- Drinking water quality monitoring

WTW Terminal/controller MIQ/TC 2020 3G

- The heart of every IQ SENSOR NET system 2020
- Multi-parameter system for up to 20 sensors, with USB interface, remote maintenance and remote communication
- High-performance processor coordinates all tasks
- USB interface allows quick data exchange via USB stick or directly to external systems
- System status LED provides quick and reliable information
- Including a second unit as mobile terminal enables flexible handling and maintenance
- Full remote access with IQ WEB CONNECT



MIQ/TC 2020 3G

SensoLyt® 700 IQ

- Digital pH/ORP armature with integrated preamplifier, temperature sensor and lightning protection
- For connection to IQ SENSOR NET
- Reliable signals with digital signal processing
- Convenient calibration in the lab and glass breakage detection

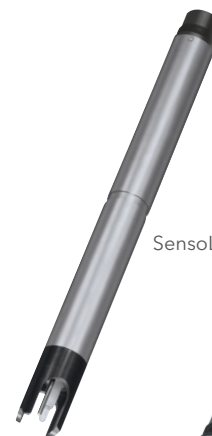

SensoLyt® 700 IQ

TetraCon® 700 IQ

- Digital IQ conductivity measuring cell
- Four-electrode conductivity measuring cell with flow-free operation.
- Very large measuring range, from 10 μ S/cm to 500 mS/cm
- Highest linearity and very high contamination resistance
- Rapid temperature compensation with integrated temperature sensor



TetraCon® 700 IQ

FDO® oxygen sensors

- Digital IQ sensors for dissolved oxygen
- Calibration-free, reliable, DIN compliant
- Effective regulation of biological cleaning steps.
- Calibration-free and flow-free
- Insensitive to air bubbles
- Low usage costs



FDO® 700IQ

VisoTurb® turbidity sensor

- Optical turbidity sensors according to nephelometric principle
- Compliant with DIN EN 27027 and ISO 7027
- Ultrasonic cleaning without mechanics
- Extremely low maintenance, service contract optional
- Highly accurate factory calibration
- High operational safety (sensor check function)



VisoTurb® 700IQ

Multi-parameter monitor MULTILINE 1000

- Flexible measuring system for drinking-water analytics.
- Measures pH, ORP, oxygen, conductivity, turbidity, free or total chlorine
- Simple to connect
- Pre-mounted on wall-mounting plate
- User-friendly menu system and large touchscreen
- No use of chemicals, reducing environmental footprint and costs
- Also available in single analog transmitters



Multiline 1000

Drinking water analyzer Chlorine 3000

- Photometric analyzer with large measuring range and high resolutions for free and total chlorine
- DPD method according to US EPA
- Low use of reagents
- 30 days of maintenance-free operation
- Very good price/performance ratio



Chlorine 3000

Turbidity meter TURB 2000

- Nephelometric turbidity meter with large measuring range
- Integrated bubble trap and white light according to US EPA 180.1
- With high sensitivity for small particles using white light
- Easy calibration with standards traceable to Formazine



Turb 2000

Flygt ENM-10, NF 5 & LTU 601/801, MJK EXPERT, Chatter, Shuttle & MagFlux

Xylem's comprehensive range of liquid flow and level measurement instruments from its Flygt and MJK brands gives you valuable feedback over processes and tasks in pressured pipes, water storage, water networks and more. The range, which prioritizes measuring quality, usability and lifetime, includes electromagnetic, hydrostatic, ultrasonic and mechanical contacts. All devices are designed to be the most robust and reliable for their specific purpose.

Applications

- Surface water pumping
- Water transfer
- Water storage and distribution
- Water flow metering
- General plant services

Flygt ENM-10 and NF 5 Level Switch

- Most reliable and simplest switches for filling/emptying applications such as starting and stopping of drainage pumps and for the basic pumping stations (high level indication)
- Switches on/off at +/- 45° (ref. to horizon line)
- Available in different versions with or without plug
- Counterweight available as an accessory



ENM-10

Flygt LTU 601/801 and EXPERT Hydrostatic Level Transmitters

- Modern and technically advanced level transmitters
- Breaks new ground offering configurability, scalability and maintenance possibilities as well as preconfigured, high-performance level measurement.
- Robust and available in many versions



LTU 601

LTU 801

MJK Chatter®

- Battery-powered data logger with modem, typically used to monitor and log ground water levels, pressure, temperature, flow, etc. in drinking water systems and boreholes far from the main power supply
- Data transmissions can be via a simple SMS or as e-mail with attached CSV package over cell phone network GSM/GPRS to SCADA systems



Chatter®

MJK Shuttle Ultrasonic Level Measurement

- Stable and intelligent level transmitter requiring a minimum of maintenance
- Mainly used in drinking water reservoirs, without physical contact with the measured drinking water, and to measure water levels in harbors, canals, etc.
- Works with a very low spread of the ultrasonic beam, easing the installation process
- Simple to install and use, with wizard and clear symbolic display
- Two built-in relays can be used as a level/system alarm or pump controller



Shuttle Ultrasonic Sensor

MJK and Flygt MagFlux Electromagnetic Flow Meters

- Extremely stable and accurate flow measurements in pressurized closed-pipe systems.
- User-friendly multilingual display panel has multiple mounting options and provides all instructions in clear text
- A single display can operate up to four flow converters and sensors
- Sensors are easy to install.
- Meets ISO-standards for installation build in lengths
- MagFlux 7200 holds the WRAS certificate



MagFlux

Sensus Water Meter ResidiaJet, Multijet & Volumetric meters, MeiStreamRF, iPERL, SensusRF

Xylem's Sensus water metering devices help water utilities and cities do more with their infrastructure to improve the quality of life in their communities. We enable our customers to reach further through the application of technology and data-driven insights that deliver efficiency and responsiveness. We partner with them to anticipate and respond to evolving business needs with innovation in communications technologies, advanced meteorology, data analytics and services.

Applications

- General plant services
- Water flow metering
- Plant and general Network services

ResidiaJet

- Single-jet dry dial water meter with magnetic coupling
- Provides protection against external magnetic fields in accordance with EN 14 154, over the whole measuring range
- Modular register; ready to connect an electronic communication module (e.g., radio or M-Bus)
- Cold water and hot water versions available (up to 5°C or 90°C respectively)



ResidiaJet

Multijet meter 420/420PC

- High reliability and quiet operation
- Dial housed in a lubricant-filled case, protecting it from impurities, and preventing fogging or the build-up of algae
- Standard, retrofittable HRI interface enables use in any network where a reliable and versatile AMR system is required



420 / 420PC

Volumetric meter 620

- High-precision, MID approved R400 volumetric water meter with a unique piston-measuring chamber that detects even the lowest flow rates
- A clear view through register with integrated wiper or sealed fog-free metal/glass register
- AMR-ready for a faster and more comfortable readout
- Broad product range enables adaptation to any AMR needs
- Tamper-proof design
- Long service life



620

Volumetric meter 620C/620MC

- The MID-approved high-accuracy water meter
- Unique piston measuring chamber detects even the lowest flow rates
- A clear view through register with integrated wiper or a sealed fog-free metal/glass register
- AMR-ready for a faster and more comfortable readout
- Designed with recyclability in mind



620C / 620MC

Volumetric meter 640C/640MC

- MID-approved, high-accuracy water meter
- Unique piston measuring chamber detects even the lowest flow rates
- Electronic register with integrated radio functionality for fast and easy communication
- Broad range of solutions enables adaptation to all AMR and AMI requirements
- Electronic register with IP 68 protection class
- Tamper-proof design
- Long service life
- Model 640 also available in brass



640C / 640MC

MeiStreamRF flow water meter

- Industrial water meter equipped with bi-directional radio for walk-by/drive-by and small fixed networks
- Integrated SensusRF radio system provides the advantages of both unidirectional and bidirectional communication
- Large measuring range makes it suitable for both high and low flow rates
- Can be used for leakage detection and reduction of non-revenue water



iPERL® water meter

- High-performance solid-state smart meters with integrated bi-directional communications capability
- Unique technology provides unrivalled, sustained accuracy over expected 15-year operational life
- Low-flow measurement of 1l per hour helps reduce non-revenue water
- Can be programmed to provide highly granular data at 15-minute intervals, which improves accuracy in identifying customer-side leaks
- Data capability helps you manage distribution networks more efficiently, conserve water, provide accurate billing to customers and informs about leaks, fraud or unusual usage patterns



SensusRF communication system

- Advanced walk-by/drive-by radio system for retrieving data from meter endpoints for further processing and analysis, for example in billing and network management
- Optimized license-free bi-directional radio communications system for battery powered endpoints
- Provides a pathway to move from mobile read to fixed infrastructure for remote reading, without changes to the endpoints
- OMS compatible and available for operation at 433 MHz and 868 MHz

SensusRF Mobile Reading



Walk-by meter reading

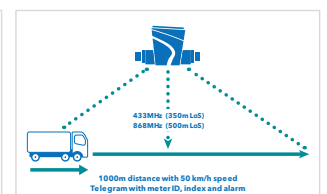

Drive-by meter reading

*Sensus Interface Radio Tool

DIAVASO – Mobile application suite

Xylem’s Diavaso is a suite of applications for remote meter reading with SensusRF radio using smartphones or tablets.

The Diavaso application suite consists of 5 individual apps; SensusRF Finder, Collection Station, Collection Mobile, Configuration & Service, and Data Logger. These can be used individually or in combination depending on your requirements for remote meter reading (AMR) or small scale fixed network (AMI).

The mobile applications run on an Android™ device and communicate with the SensusRF radio transceiver SIRT (Sensus Interface Radio Tool). The Diavaso apps are compatible with all SensusRF meters and repeaters.

The Diavaso apps are designed to be used for meter installation, remote reading, maintenance and configuration of meters and repeaters. The Collection Mobile also includes a server based interface (web portal) for managing the meter reading workflow, reporting as well as data exchange with the billing system.



Accessories

- HRI (high resolution interface): Universal sensor compatible with a wide range of meters
- HRI-Mei: Data capture device for MeiStream and MeiTwin MID bulk water meters
- SensusRF: Gateway for fixed radio network; can interface with: short-range devices (SRD) and long-range radio (LRR)
- Sensus PulseRF: Radio transponder enabling integration of meters with pulse output into the SensusRF radio network
- The SensusRF Radio Repeater: Bi-directional, compact radio module for automatic meter reading (fixed network or walk by/ drive by)
- SIRT (Sensus Interface Radio Tool): Radio modem for Sensus Radio connection to the PSION handheld via Bluetooth, and using SensusREAD software



SensusRF Gateway



SensusRF Radio Repeater



SIRT



Sensus PulseRF Radio Transponder

SmartBall® Technology, PipeDiver® Technology

Xylem’s Pure Technologies provides intelligent leak detection and condition assessment solutions to help water and wastewater pipeline owners reduce non-revenue water and wasteful expenditures such as replacing good infrastructure prematurely. The company’s inspection solutions include the free-swimming SmartBall and PipeDiver tools. With SmartBall tool based on acoustic technology for leak detection and the PipeDiver tool based on electromagnetic technology for detection of wall loss, pipeline owners can optimize assets at a fraction of the cost of replacement programs.

Applications

- General Network services
- Pipeline condition assessment
- Leak and burst detection
- Non-revenue water reporting

SmartBall® Technology

- Free-flowing leak detection tool that locates leaks and gas pockets in pressurized pipelines
- Effective with any pipe material
- Capable of completing long leak detection surveys in a single deployment, without disruption to regular pipeline service
- Highly sensitive acoustic sensor enables location of pinhole-sized leaks
- Requires only two access points for insertion and extraction
- Tracked throughout the inspection at predetermined fixed locations on the pipeline

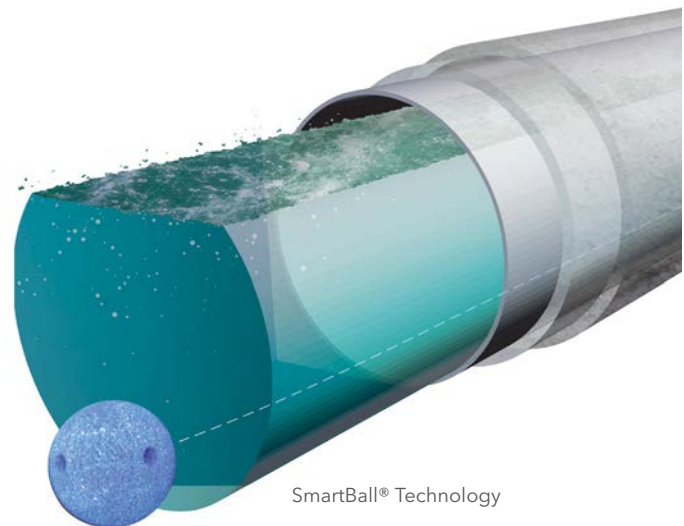

SmartBall® Technology

	SmartBall® Leak Detection
Tool Type	Free-Flowing
Pipe Materials	All
Pipe Diameter	250 mm and larger
Typical Location Accuracy	± 2 m
Insertion point size	100 mm or larger
Inspection Length	Up to 25 km
Pipeline Mapping	Yes
Inline video	No

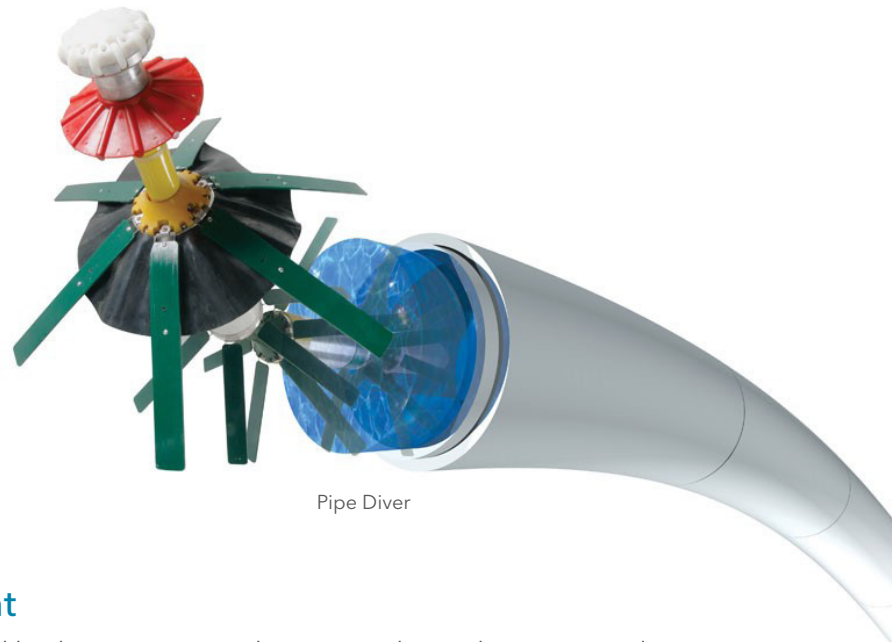

PipeDiver® Condition Assessment

The PipeDiver platform is ideal for wall loss and broken wire wraps detection in large-diameter pipelines that cannot be removed from service.

- No disruption to regular pipeline service
- Long inspection distances can be covered in a single deployment
- Accurate results that pinpoint areas of distress help optimize repair planning
- Effective on a variety of pipe materials
- More cost-effective than methods that require shutdown and dewatering

	PipeDiver EM inspection for pressure concrete pipes	PipeDiver EM inspection for metallic pipes
Tool type	Free-Flowing	Free-Flowing
Pipe Diameters	400 mm and larger	400 mm and larger
Deliverables	Number of wires breaks	Corrosion/distressed area
Inspection length	Similar situation as SB	Similar situation as SB
Mapping	No	No
Inline video	Yes*	Yes*

* The inline video depends on the pipe diameter and water turbidity

Visenti View™, LeakView™, SurgeView™

Xylem’s brand, Visenti, provides water utilities with an intelligent suite of sensor hardware and software service solutions to proactively monitor and manage the water distribution network more effectively, curb non-revenue water, and provide predictive asset management of their water systems. The solutions include real-time leak detection, NRW reporting, identification of pipe network assets at risk of failure, operational simulations, and water quality monitoring.

Visenti’s integrated solutions take a holistic view of the water network and combine all data sources to provide a 360-degree intelligent eye across a utility’s assets, making it easier for all departments to collaborate and make informed decisions.

Applications

- Pipeline condition assessment
- Leak and burst detection
- Non-revenue water reporting
- Transient pressure monitoring
- General network services

Visenti’s View™

- Internet of Things (IoT) solution with analytics, designed for water networks
- Allows you to make the most of existing data and systems
- Scalable system that manages data from different sensors, e.g., flow-rate, level, volume totalizer, pressure, water quality and automated customer meters
- Wide range of real-time analytical capabilities to monitor, detect and notify about anomalies related to pressure variations, night flow, water quality issues, demand fluctuations and consumer-level non-revenue water tracking
- Can be deployed to monitor the performance of the entire water network, and swiftly respond in case of anomalies



LeakView™

- Real-time leak and burst detection service with pressure and acoustic sensors to identify events 24/7 and provide alerts to customers as quickly as 15 minutes
- Enables proactive leakage management, reduction of leak run-time, and early warning of major bursts
- Pressure measured at hundreds of samples per second to detect pipe breaks
- Hydrophones used to track leaks before they become catastrophic bursts
- Sensing devices are synchronized with GPS, with data sent via 3G; can be deployed in existing network chambers
- Suitable for all pipe materials and diameters



SurgeView™

- Service that uses high-rate pressure data to identify and predict which assets are in poor condition and likely to break within a water network
- Allows preventive action to be taken to extend pipe lifetime
- Condition assessment and leakage identification surveys can be targeted towards at-risk pipe sections, saving time and resources

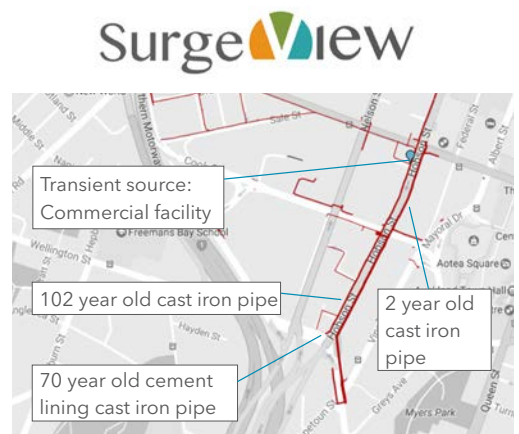

Pipelines at risk of failure identified based on exposure to transient pressure, asset data and history of breaks.

	Pressure Transient	Hydrophones
Network	Long distance up to 1,0 km	Small Distance up to 500 m
Pipe Size	All Pipe diameters	Most effective on pipe diameters below 600 mm
Pipe Material	All pipe materials	Best suited on metallic pipes
Detection Time	24/7 Detection	Most effective during night time/ during quiet hours
Network Types	Suitable to all network configurations - DMA, Trunk Mains, Open Networks	Suitable to all network configurations - DMA, Trunk Mains, Open Networks
Localization Accuracy	Leak Localization Accuracy up to +/- 50 m - with each sensor covering several km of pipe	Can potentially pin-point leak events up to +/- 5 m
Alert Time	Alert sent within minutes of the occurrence of pipe burst	Alerts are monitored over a period of 24-48 hours to confirm existence of developing leak
Type of Leak	Detects newly occurring bursts	Detects leaks growing over time

Xylem TotalCare services Designed around your needs

Xylem TotalCare offers a comprehensive service portfolio including traditional maintenance and predictive maintenance solutions to keep your equipment running reliably at all times. Our teams of knowledgeable and skilled technicians are capable of intervening quickly to address any performance or reliability issues that you face with your water and wastewater equipment and infrastructure.

Genuine OEM Spare Parts

- Genuine OEM spare parts tailored to fit your Xylem equipment and developed with performance and quality tests conducted right from the design phase
- Benefit from the latest innovation in the design of parts with all genuine Xylem parts to fit your water and wastewater equipment
- Guaranteed technical and engineering support with all genuine Xylem parts

Emergency Response and On-Site repairs

- Skilled technicians with the right tools to intervene
- Fast mobilization of the right technicians with the right skills thanks to our large, global service footprint
- Large fleet of rental equipment to ensure minimal downtime and secure the continuity of your operation.

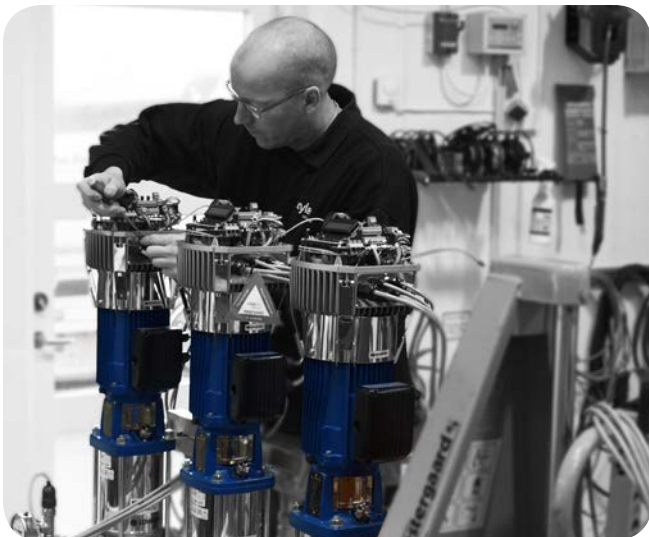



Preventative Maintenance Contracts with remote monitoring of equipment

- Detailed process knowledge across the water cycle to monitor the right parameters
- Advanced monitoring & control equipment and software to detect and resolve potential issues before serious failures
- Real-time monitoring and tracking of your critical assets to optimize equipment performance, monitor their reliability and intervene quickly when performance deteriorates, saving you downtime costs and improving equipment availability

Rental Solutions

- Wide range of rental solutions, including the newest equipment in the Xylem portfolio to mitigate the impact of equipment failure
- Xylem engineering expertise included in all Xylem rental solutions
- Long-term rental with equipment maintenance contract available
- Rent-to-buy option to try the newest technologies in pumping and treatment, assess fit for purpose and test the performance benefits that come with the latest technology



Technical consultation service



Installation and commissioning



Maintenance contracts



Workshop repairs



Monitoring and supervision



Inspection and audit



Training



Parts and logistics



Pump hire and service



Equipment refurbishment

Xylem |'zīləm|

- 1) The tissue in plants that brings water upward from the roots;
- 2) a leading global water technology company.

We're a global team unified in a common purpose: creating advanced technology solutions to the world's water challenges. Developing new technologies that will improve the way water is used, conserved, and re-used in the future is central to our work. Our products and services move, treat, analyze, monitor and return water to the environment, in public utility, industrial, residential and commercial building services settings. Xylem also provides a leading portfolio of smart metering, network technologies and advanced analytics solutions for water, electric and gas utilities. In more than 150 countries, we have strong, long-standing relationships with customers who know us for our powerful combination of leading product brands and applications expertise with a strong focus on developing comprehensive, sustainable solutions.

For more information on how Xylem can help you, go to www.xylem.com



Xylem Water Solutions UK Ltd.,
Private Road No1, Colwick
Nottingham NG4 2AN
Tel 0115 940 0111
Fax 0115 940 0444
www.xylem.com/uk